

AT MICROFICHE REFERENCE LIBRARY

A project of Volunteers in Asia

Approved Practices in Soil Conservation

by: Albert B. Foster

Published by:

The Interstate Printers & Publishers, Inc.
19-27 North Jackson Street
Danville, IL 61832 USA

Paper copies are \$ 7.50.

Available from:

The Interstate Printers & Publishers, Inc.
19-27 North Jackson Street
Danville, IL 61832 USA

Reproduced by permission of The Interstate
Printers & Publishers, Inc.

Reproduction of this microfiche document in any
form is subject to the same restrictions as those
of the original document.

APPROVED PRACTICES
IN
SOIL CONSERVATION

by

ALBERT B. FOSTER

Formerly of Soil Conservation Service
United States Department of Agriculture

THE INTERSTATE
Printers & Publishers, Inc.

Danville, Illinois

Fourth Edition

Copyright © 1973 by
THE INTERSTATE
Printers & Publishers, Inc.

All Rights Reserved

First Edition, 1955
Second Edition, 1959
Third Edition, 1964

Library of Congress
Catalog Card No. 72-81495

Printed in U.S.A.





(Photo: U. S. Soil Conservation Service)

Complete soil conservation treatment on this small watershed illustrates the type of change involved in protecting the land against loss of soil and water. The flood-retarding structure protects property downstream from flooding and at the same time furnishes a wildlife and recreation area. Protecting the reservoir from sedimentation are terraces, diversions, waterways and contour strip cropping.

FOREWORD

This book is for the individual who would apply the conservation practices described here without technical assistance, or at least with a minimum of such assistance. It is for the student who would practice soil and water conservation with some guidance from his instructor. And it is for the person who would apply the principles involved in basic soil and water conservation in his own way, to his own conditions, and within his own capability to apply them.

To meet these needs, the book includes a discussion and description of the soil and water conservation methods for the small operator while at the same time recognizing the changes that have been brought about through improved technology and by larger and more complex farm equipment. It is intended to be useful for the farmer and rancher, for the camp manager, for the contractor and builder, and for the urban dweller who has a soil and water conservation problem on his small acreage. Practices discussed here can help the school official select a site for a school and develop a conservation plan on the area—a plan that can be used to teach wise use of soil and water and related resources and serve as an outdoor classroom.

No discussion of modern soil and water conservation could ignore the changes that have transpired during the past 10 to 15 years in farming and earth-working methods, brought on largely by improvements and developments in tillage and earth-moving equipment. These changes have had their effect on soil and water

conservation. As farming methods change, the methods of controlling erosion on farms and ranches likewise change. The basic principles that were developed through research and experience have not changed; but the changes in farming methods and other advancements make it necessary to adjust the application of accepted principles to new conditions.

Probably the most spectacular change in farming methods has been brought about by the development and use of larger and faster farming equipment. Two- and 4-row equipment is being replaced by 6-, 8-, or 12-row equipment. The spacing of rows has been narrowed for many crops, especially corn.

These changes in equipment have affected the application of conservation practices. For example, the problem of sharp curves and point rows was of little concern to the farmer with two-row equipment, but the problem is intensified with larger implements and faster tractors. With today's equipment the farmer cannot afford to be slowed down by sharp curves and point rows. He does not want field layouts that have extra point rows that cause more turning and reduce operating speed. He wants large fields so that turning time is reduced to a minimum.

With large machinery, waterways must be wider and must have more gently sloping side slopes. Large, fast, multirow equipment has made parallel terraces a necessity for rowcrop cultivation. Small machinery could negotiate the sharp curves, but it is not feasible with today's large equipment. Many farmers find it profitable to re-shape and smooth the land surface in order to eliminate sharp curves so that they can use their large machines.

In some instances large machines have forced farmers to farm off the true contour in order to avoid sharp curves. Since this increases the erosion hazard, some method of compensating must be used. Making greater use of plant residues is one way. The increased use of minimum tillage, which leaves crop residues on

the surface, is helping to accomplish this objective.

Large equipment has helped in the control of large gullies. Today's bulldozers, scrapers, root plows, and compaction rollers make the work of filling a gully easier, faster, and less costly and do a better job.

Another recent development is the increased need for information about the soil. Farmers and ranchers have for a long time used information about the soil in planning for its efficient use. Now home builders, highway engineers, architects, tax assessors, zoning boards and commissions, and planners and developers are finding this information vital to their needs. Literally millions of dollars can be saved by developers, for example, by knowing the effect certain soils have on sewer pipe, on foundations, or on the stability of the building site itself. Many home owners have found, to their sorrow, that the septic tank will not function, or that the shrinking and swelling in the soil under their homes has ruined the foundation.

Fortunately, through the combined efforts of the U. S. Department of Agriculture and the State Experiment Stations, a national cooperative soil survey program is going ahead in full swing. Soil survey information, as a result of this program, is available in virtually every county in the nation. Many of these surveys have been published, and detailed maps with scale of 3 or 4 inches to the mile are available to anyone who can use them. There is no need today for anyone who needs soil information in carrying on his profession to be without it.

THE AUTHOR

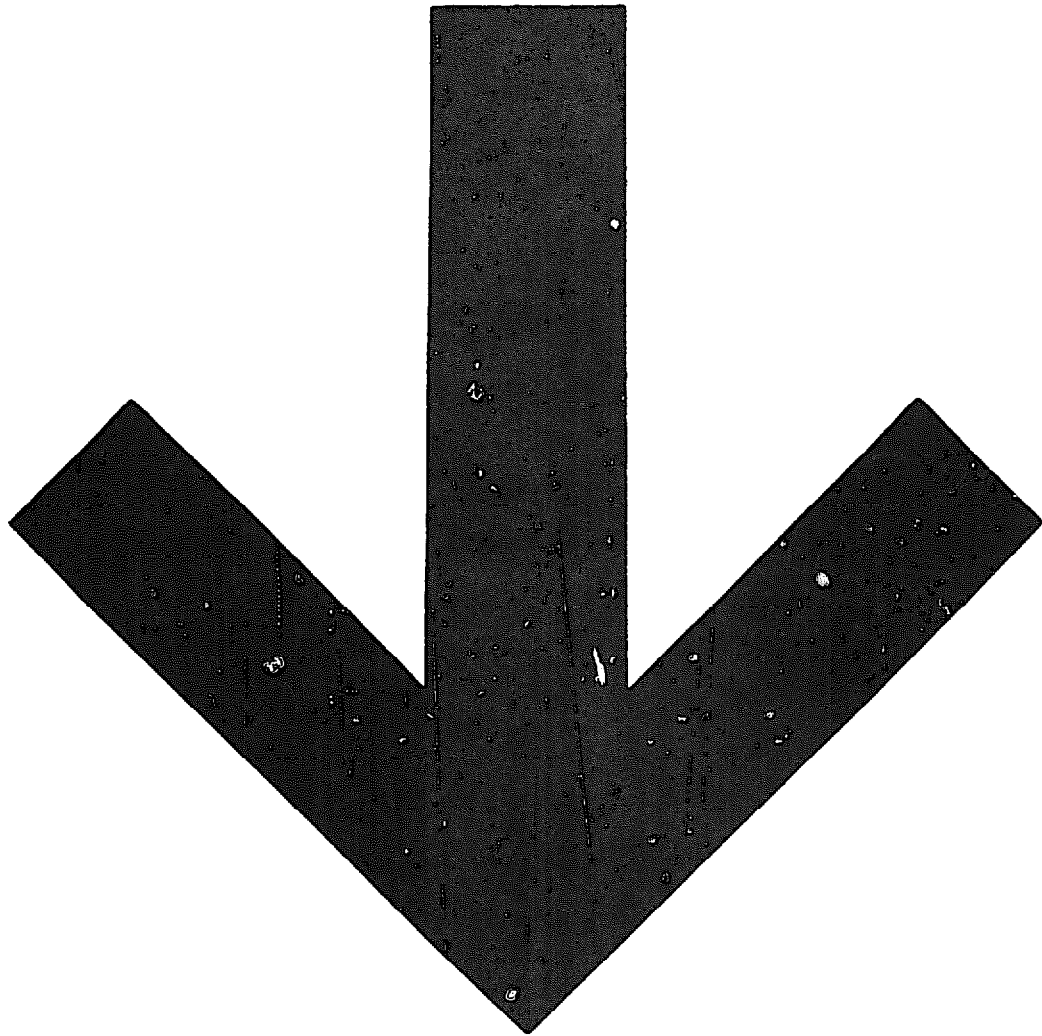

TABLE OF CONTENTS

	Page
Foreword	v
Introduction	xi
Chapter	
I. Using Land Within Its Capability	1
II. Using Cropping Systems that Conserve Soil and Water	23
III. Engineering Instruments	39
IV. Calculating the Runoff from a Watershed	57
V. Grassed Waterways and Outlets	69
VI. Farming on the Contour	87
VII. Contour Fences	101
VIII. Strip Crop Farming	109
IX. Laying Out and Constructing Terraces and Diversions	131
X. Minimum Tillage	183
XI. Laying Out and Constructing Ponds	201
XII. Preventing and Healing Gullies	235
XIII. Controlling Erosion on Construction Sites ..	255
XIV. Controlling Sandblows.....	275

Chapter	Page
XV. Planting Shelterbelts	283
XVI. Managing Farm Woodlands	291
XVII. Managing Land for Wildlife	315
XVIII. Improving and Managing Pastures and Ranges	343
XIX. Laying Out and Constructing Farm Drainage	365
XX. Conservation Irrigation	407
XXI. Using Land for Recreation	423
Appendix	441
Glossary	469
Index	495

INTRODUCTION

Soil Conservation—the Concern of All

Soil and water conservation is accepted as a way of farming and ranching on much of the nation's farm and ranch land today. And while there are millions of acres on which soil erosion is still the major problem, the more progressive farmers are practicing soil conservation in tilling their land. Additional landowners are joining their ranks each year. As a matter of fact, no landowner can afford to let his capital investment decrease in value by allowing the soil to wash or blow away.

For a long time in this country soil conservation was looked upon as the concern largely of farmers and ranchers. The soil that washed down the slopes and into the streams belonged to the farmer. Reduced yields that resulted from the loss of surface soil, rainfall that ran off and did not soak into the soil, and fertilizers that washed off with the soil instead of feeding the crop hurt the farmer. And benefits from conservation work, such as increased yields and reduced costs, accrued to the man on the land. Even after Congress recognized soil erosion as a national problem and decided that it was in the public interest to do something about it, people as a whole continued to look upon soil and water conservation largely as a farm problem.

This is no longer true. People have become concerned about the environment. At first it was largely the productive capacity of the land that appeared to be threat-

ened. With a rapidly increasing population, some long-range forecasters warned that the nation's food-producing capacity was endangered. Greatly improved technology in farm production has largely dispelled this fear, at least for the foreseeable future, even though erosion is still a serious problem on much of our agricultural land. More will be said about this later.

People who do not live on farms now realize that soil eroded from farmland by wind and water finds its way into streams, reservoirs, roadside ditches, harbors, and into the air we breathe. It is expensive to remove it, more expensive than keeping it on the land with conservation measures. Soil in water, known as sediment, is by far the nation's largest single water pollutant.

In addition to damage from soil eroded from farm and ranch land, some of our agricultural technology that has contributed to the great increase in farm production is now considered by many to be hazardous to the environment. Along with the soil that is washed into lakes and streams come the phosphates and nitrates, originally applied in fertilizer, which cause a degrading of the oxygen supply in water. The concentration of farm animals in feedlots has created a pollution problem arising from the accumulation of animal wastes. These pollutants contributed by farmland add to those from city sewage and from factories.

In scattered areas erosion from urban development is becoming a serious problem.

The increased interest and concern for the quality of life based on a clean environment, along with the growing population and increasing affluence, are leading to the establishment of new values and a new set of priority goals. The mounting concerns on the part of the public have already been reflected in new environmental legislation, new organizations and pressure groups, and the demand for new and increased efforts in research. While the farmer and rancher own and control the land and will do what conservation work is done, more public support is now assured for the job

they have to do.

This increased public support is more than a willingness to pay for the cost of technical assistance and for cost-sharing some of the more permanent conservation practices. Now the landowner is being urged to get on with this job that now concerns the people everywhere.

It took some time for the people of this country to realize that we had been using our soil and water resources in a way that was causing actual damage to the resources themselves. Soil erosion had been occurring but had been accepted as a natural result of farming. Small rills were smoothed over, gullies were plowed in, sediment piled at the foot of slopes was worked over, and other effects such as reduced yields were either not recognized or were simply overlooked. At the same time, streams and lakes were muddied with soil that came from the fields, and the effects on water supplies, fish, and other marine life were gradually intensifying.

Of course American farmers were not the first to experience soil erosion. Cultivators in every nation since the earliest recordings of history have been trying, even in crude ways at times, to keep the rain from washing away the soil. Landowners in some of the earliest civilizations constructed bench terraces on steep slopes. Crop rotations have been practiced in Europe for many centuries. It was partly because of the torrential-type rain prevalent in this country, along with the fact that the early settlers were accustomed to a slow, gentle, mist-like precipitation, particularly in northern Europe, that they did not appreciate the effects of their farming methods on the land here.

But regardless of the variety and interplay of causes and effects, soil erosion grew more serious as the nation grew. The early settlers tended to farm their land up and down hill or in whatever manner was easiest for them. And when the land no longer produced as much as was needed, they simply moved on to new land that seemed unlimited in supply in a country where the

frontier extended endlessly westward.

Gradually soil erosion and its related effects came to be seen as a hazard, not only to the landowners themselves but to the people as a whole. Through the efforts of a few far-sighted leaders, supported by work at some of the state experiment stations and backed up by experience of leading farmers, Congress decided that the public interest was involved. Legislation was passed setting up experiment stations and later providing for demonstrations and direct technical assistance to landowners.

Conservation techniques devised by scientists had to be applied by the farmers because they, not the scientists, owned and controlled the land. At the same time, many of these techniques involved the use of engineering instruments and other tools unfamiliar to the farmer. Furthermore, some erosion problems involved more than one farm—in some cases a large number of farms, such as in a watershed—, and ways had to be found that would enable all the farmers affected to plan and work together to solve the problem. In these instances the cost of solving the problem was usually greater than one farmer could afford, even though the gully or whatever was causing the trouble may have been located on only one farm.

In some cases runoff water from one farm was causing damage on the neighbor's property. And after the conservation work was accomplished, the benefits accrued to land and to people off the farm where the problem was located.

This type of situation supported the idea, already accepted by some people, that government assistance should be made available to help the landowner with his conservation work. And it led to political changes, such as the organization of conservation districts and watershed associations, and to the use of powers available to people inherent in a democratic society.

In addition, it has been generally accepted that a prosperous agriculture is essential to the prosperity of

the nation. If the land wears out and agriculture suffers, the prosperity of the nation is affected. And it is not necessary to point out to city people that food does not originate on the shelves of the supermarket. Beef produced on a Kansas farm may be consumed in a city a thousand miles away. It naturally follows that the well-being of the Kansas farm and its capacity for continuing to produce beef is the concern of the family in the city.

Since it is generally agreed that conservation of the nation's soil and water is essential, and since landowners who have control of the land must actually carry out conservation, some form of inducement would appear to be helpful. Government assistance in the form of technical guidance and cost sharing has already been mentioned. Another inducement is the belief that soil conservation farming pays off economically for the farmer. At least there is considerable evidence to support the belief that money spent for conservation is a sound investment.

Benefits may not always be immediate in terms of increased yields and profits. Some practices, such as terracing, disturb the soil so that a year or two must pass before normal production can continue. Research shows, however, that increases in yields usually make up for this short-term loss.

Undertaking a conservation plan inevitably involves some additional cash expenditure on the part of the landowner. As pointed out later in this book, a conservation plan may require converting the land use from cultivated crops to grass or some other enterprise, where the returns are not immediately forthcoming. This would mean postponing income in order to meet the demands for solving the erosion problem on a particular piece of land.

Several years ago the Soil Conservation Service made a study on 503 midwestern farms. Economists selected farms that were comparable in size, had similar land capability, and were located in the same general area.

Of the group, 252 were being operated under well-developed, complete farm conservation plans. On the remaining 251 farms, little or no soil conservation was being practiced. Information on crop acreage, yields, and the amount of crop and livestock products sold and used in the home was obtained from each farmer. Actual market prices were used in computing the income for each group. The results of the study showed the advantage in favor of the conservation farms over the non-conservation farms as follows:

Corn yield	14%
Soybean yield	14%
Oats yield	8%
Beef production	34%
Sheep production	11%
Pork production	23%
Milk production	7%

Production income (the value of the products produced on the farm, less feed purchased and the cost of conservation treatment) was 16 per cent greater per acre and per farm on the conservation farms.

Some early research in Wisconsin showed that crop yields are from 10 to 15 per cent higher on terraced than on unterraced land. Assuming no yield advantage for the first year from terraces, this study showed that it will require only three years to more than pay for construction costs.

A study in Illinois on a single practice, contour farming, showed an increase in yield from contouring of 12 per cent for corn, 13 per cent for soybeans, 16 per cent for oats, and 17 per cent for wheat.

Reduced cost of operating machinery on the contour is one reason given for higher profits. Running machinery on the level as compared with up-and-down-hill is easier on the machines and takes less fuel.

Farmers in Wisconsin reported that on-the-contour farming permits operation of machinery at about the same load and working speed most of the time, whereas

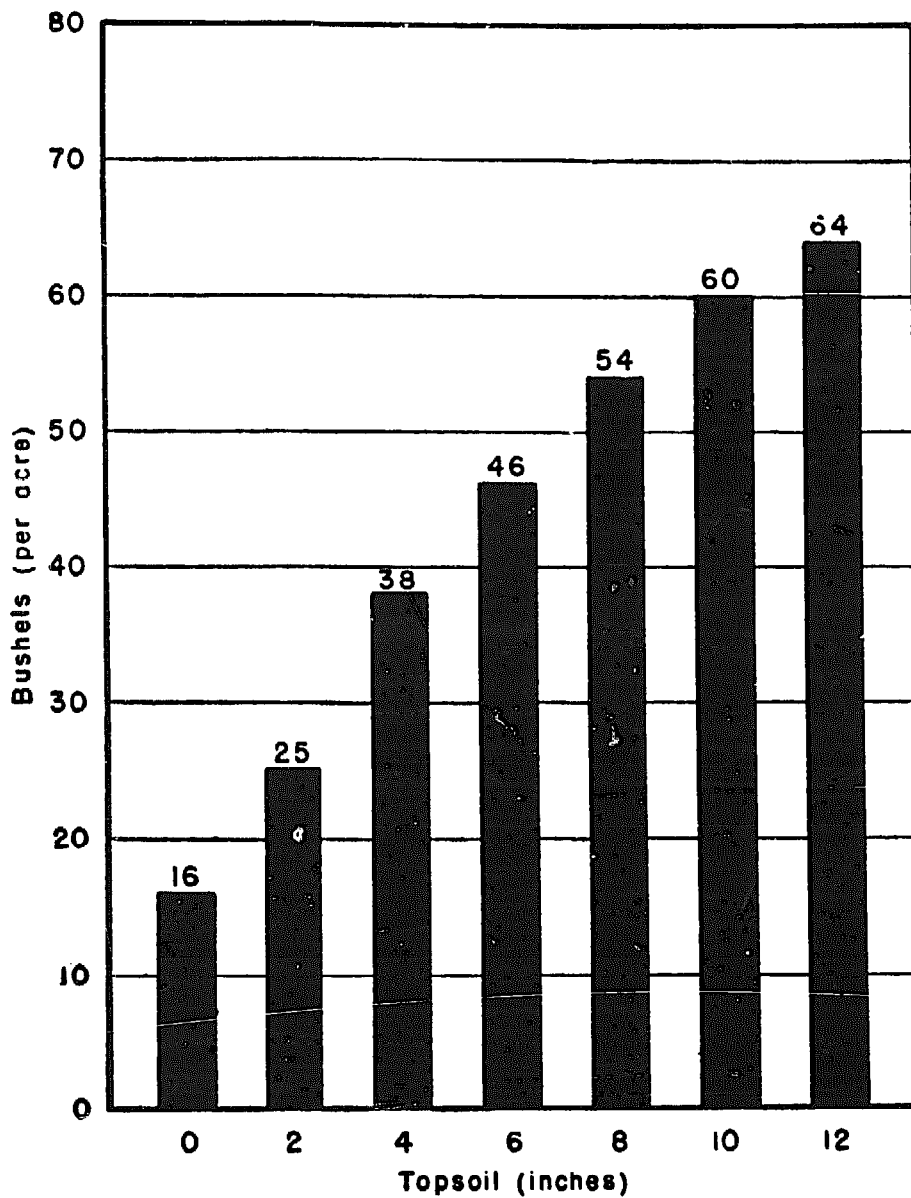

(From Soil Conservation Service Technical Publication No. 98)

Fig. 1. Average annual yield of corn in bushels per acre on Shelby, Grundy, and Mexico soils as influenced by the depth of top soil—Missouri.

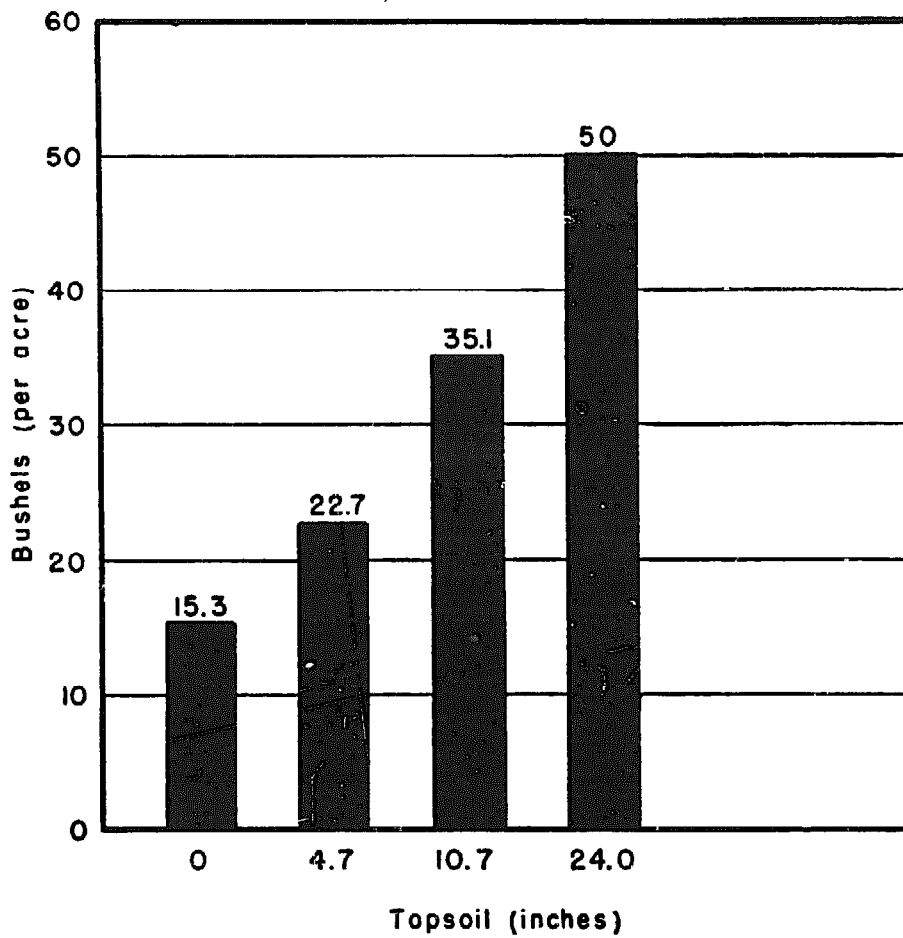

(From Soil Conservation Service Technical Publication No. 98)

Fig. 2. Wheat yields correlated with the depth of top soil, South Fork, Palouse Demonstration Project, Washington.

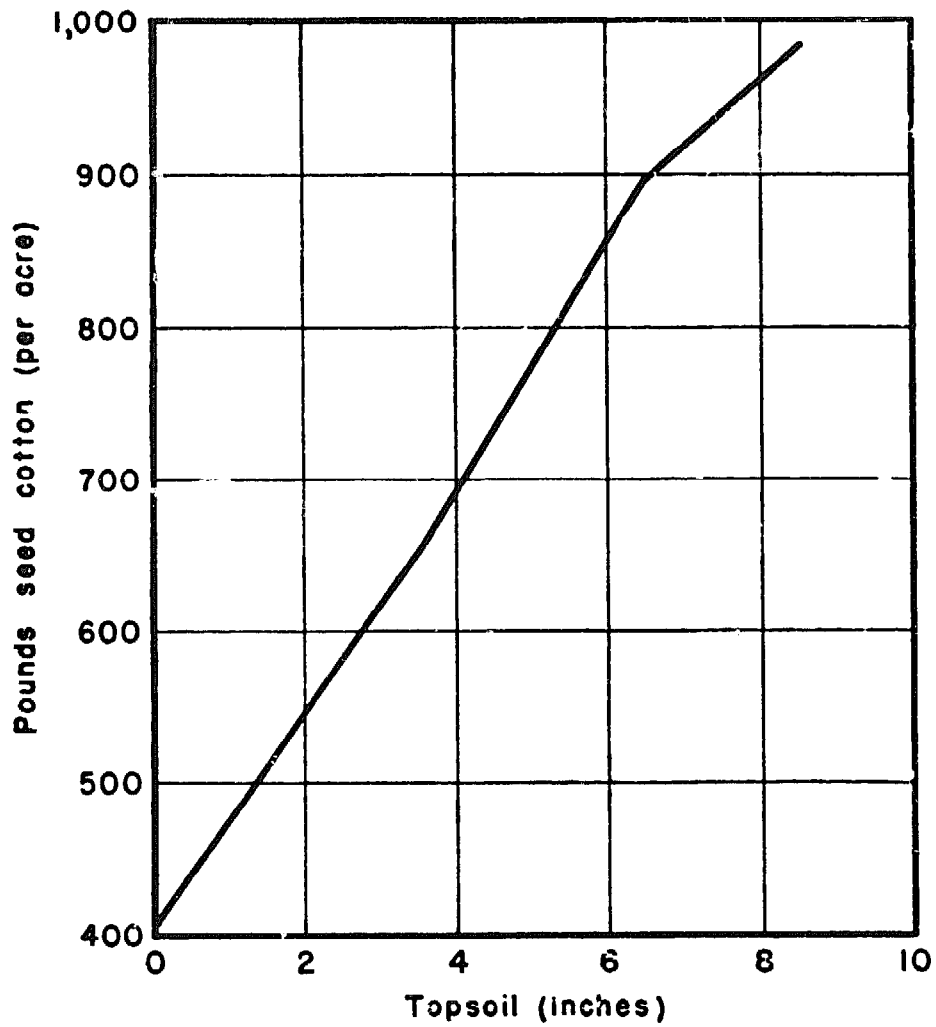

(From Soil Conservation Service Technical Publication No. 98)

Fig. 3. Correlation between depth of topsoil and cotton yield on Cecil soil at Watkinsville, Georgia.

up-and-down-hill operations frequently result in an overload on uphill travel and in an underload on downhill travel.

One study in Illinois showed that land that had been farmed hard for 40 years is dense, compact, and heavy to lift. In fact, the top 7 inches of an acre weighs about 225 tons more than it did under virgin conditions. This means more power is needed to plow the land.

Preserving the layer of surface soil results in increased yields, as shown in Figures 1, 2, and 3. Results shown in these three illustrations are based on research done at least 20 years ago. Yields today, because of improved seed varieties, fertilizers, and pesticides, and other improved cultural methods, would be much higher throughout the range of surface soil given, but the relationship between them would no doubt be similar.

It seems obvious that the major benefit to the farmer who installs a conservation plan would be over the long term. Conservation farming protects the land against decline. It enhances the production base. It increases the value of the land. Many country banks now require a soil conservation plan before making a loan.

No doubt soil conservation pays in other ways. Farmers derive satisfaction from their well-kept fields. They enjoy the wildlife that flourishes in the hedgerows, ponds, and contour strips. They leave their farms in good condition to the next generation, satisfying a moral obligation they may feel in having had the privilege of owning a piece of land.

It is possible that many farmers would not have installed conservation practices had there not been the subsidy payments available to help defray the initial cost; but it is more likely that they simply did not have the funds to make the investment, rather than that they had to be paid in order to be induced to do it. And perhaps conservation farming calls for a higher level of management than many farmers are accustomed to, and thus it was not possible for every farmer to install

and maintain a conservation system, even though he wanted to and needed no special incentive.

U. S. Department of Agriculture studies show that the nation has enough land to meet current and future needs for farm, ranch, and forest production. But while farm production has increased spectacularly in recent years, this has not been achieved at no cost to the land. Erosion is still a serious hazard on a major share of our agricultural land. The need for soil conservation is just as urgent as it always has been. Techniques that increase yields do not necessarily prevent erosion; some of the most severe erosion is occurring on the most productive land, where slopes are in excess of 3 or 4 per cent. Actually, the high yields of crops such as corn and soybeans are being produced in spite of the erosion that is taking place at a serious rate. Three-fifths of the land still needs application of conservation practices, more intense and more effective than that now being applied.

Just as people generally are beginning to recognize what present heavy demands are doing to soil and water resources, they must also realize the increasing demands on these resources inevitable in the future. Facing squarely the capacity of our soil and water resources to produce are the short range needs in the form of more people, more workers, more housing needed, more demands for recreation, more food and fiber that must be grown on fewer acres—we have only so much land, and every year some of it is disappearing under concrete and asphalt—and more land needed for urban use, roads, and other nonfarm uses.

Furthermore, future demands on soil and water resources will probably increase even more than the predicted population increase would indicate. More than 200 million persons now live in the United States. By the year 2000, the population is expected to reach 300 million, although recent trends in the birth rate indicate that this increase may reach only 250 million. But although the population may increase 50 per cent by

the year 2000, the expected economic growth of the nation could cause an increase in the production of goods and services several times that amount. These increased demands by an affluent society could put severe pressure on soil and water resources and degrade the environment further. Thus, in recognizing that the nation's economic growth is inevitable, the effects of this growth must also be recognized.

What is needed is a program to conserve and improve America's soil and water resources in order to support the steadily increasing agricultural and industrial demands of an expanding population. At the same time, these resources must be used and managed so that enough land is allocated for highways, wetlands, wilderness areas, fish and wildlife habitats, recreation, natural coast areas, urban areas, and other necessary uses.

Conservation of soil and water is no longer an end in itself but a contribution to a broader objective through its relationship to the air, water, land, space, recreation, and all those elements of the environment on which all people depend for a satisfying life. By following improved and effective soil and water conservation methods on his particular tract, the man who operates the land, whether a farmer, rancher, or manager of camp or school property, can make a major contribution to that goal. He also recognizes that soil conservation is not just a set of practices for removing safely the surplus water that falls on his land; it now must include wise use of fertilizers, insecticides, herbicides, and the handling of animal wastes.

An additional dividend from the conservation now being practiced by farmers and ranchers is the use of the technology developed largely to protect food- and fiber-producing land, on other types of land use. This technology is just as applicable to the parking lot, the subdivision, the strip mine, the camp, school, factory, airport, and highway as it is to the farm and ranch.

Chapter

I

USING LAND WITHIN ITS CAPABILITY

Selecting the proper use of the different kinds of land on the farm is the first and most important step in conservation farming. The success of all other phases of the conservation program on the farm will depend on the judgment used in selecting a land-use pattern that is within the capability of the land.

Thus, good land use is probably the most important "approved practice" of all. The other practices, such as terracing, strip cropping, crop rotations, and contour farming, are merely supplementary to it.

Selecting a good land use for each field is partly a matter of deciding whether the field is suited for crops, for pasture, for woods, or for wildlife or recreation. To do this requires a knowledge and evaluation of the physical features found on the farm. Within the capability of the land other choices must be made of the crops or other plants to be grown and the management methods that will work out best.

The physical features vary from one part of the country to the other. But they are the inherent characteristics of the land, those characteristics placed there

by Nature herself throughout the ages of land and soil formation.

Soil depth, soil color, the texture and structure of the soil, the movement of air and water through the soil, depth to water table, site factors such as upland and bottomland, slope, susceptibility to water and wind erosion, susceptibility to overflow, degree of wetness, presence of alkali or other unfavorable chemical conditions, and even the climate itself, make up most of these physical features. These are the characteristics that limit the use to which the land can be put safely. Some of them may be changed to some degree, but by and large, they must be lived with. For example, flat land, slightly wet, may be improved by drainage, but the hazard still remains and the installation of the tile or ditch is a practice which must be maintained.

Take a Land Inventory

Gathering these facts about the land is actually the making of an inventory of the land. Soil scientists specialize in this field of work and can go over a farm, using soil augers, spades, levels, and other equipment to make a soil map that can be used to learn the capability of each acre.

Soil surveys, made by the U. S. Department of Agriculture in cooperation with the State Agriculture Experiment Stations, are being made in virtually every county in the United States. A great number have been published and are available in the local County Extension office or in the office of the Soil Conservation Service. Where the soil survey has not been published, information about the soil may be obtained from employees of the Soil Conservation Service cooperating with the local soil conservation district.

But students of agriculture do not need to become soil scientists to understand and recognize many of

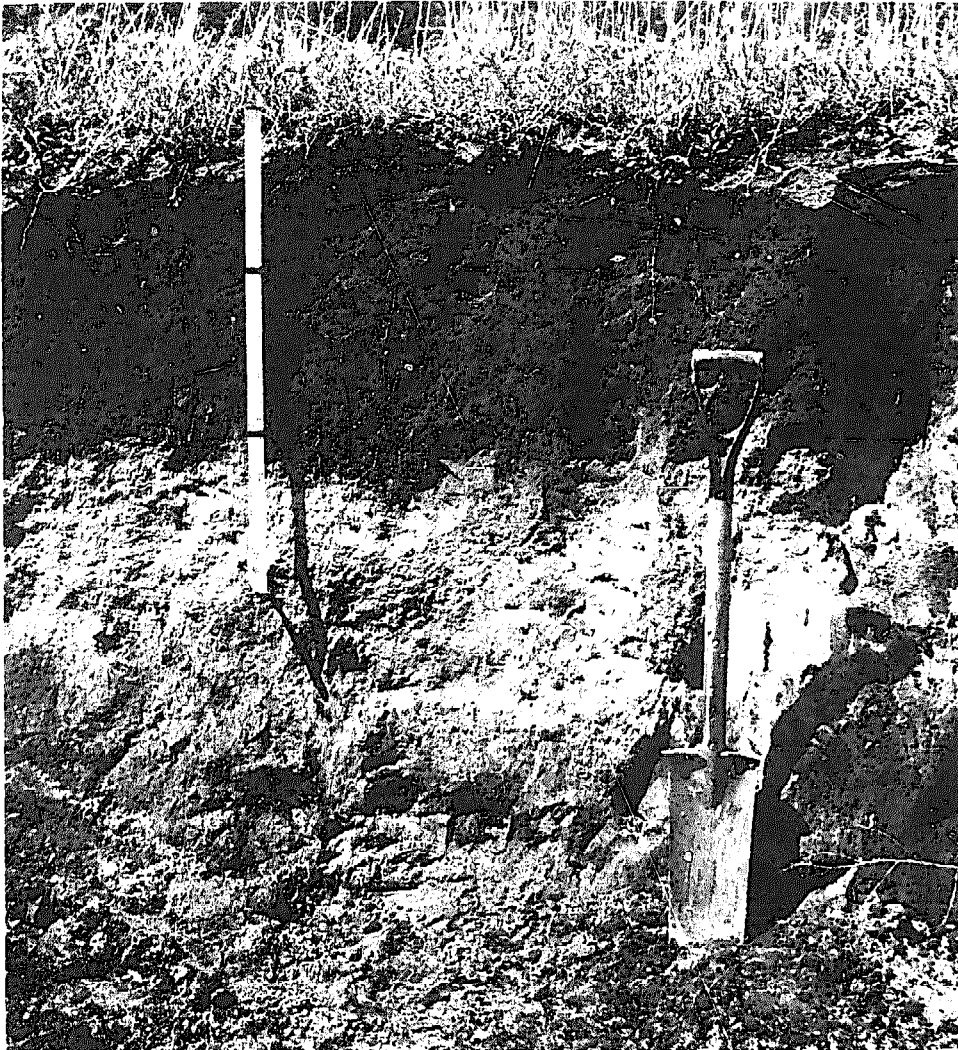

(Photo: U. S. Soil Conservation Service)

Fig 1-1. This picture illustrates a deep soil which provides plenty of room for plant roots to grow.

the characteristics of the soil. Becoming familiar with some of them will at least make for an understanding and appreciation of the land's features and how these features determine the conservation program to be followed.

Evaluate Important Land Features

In order to properly evaluate the various land fea-

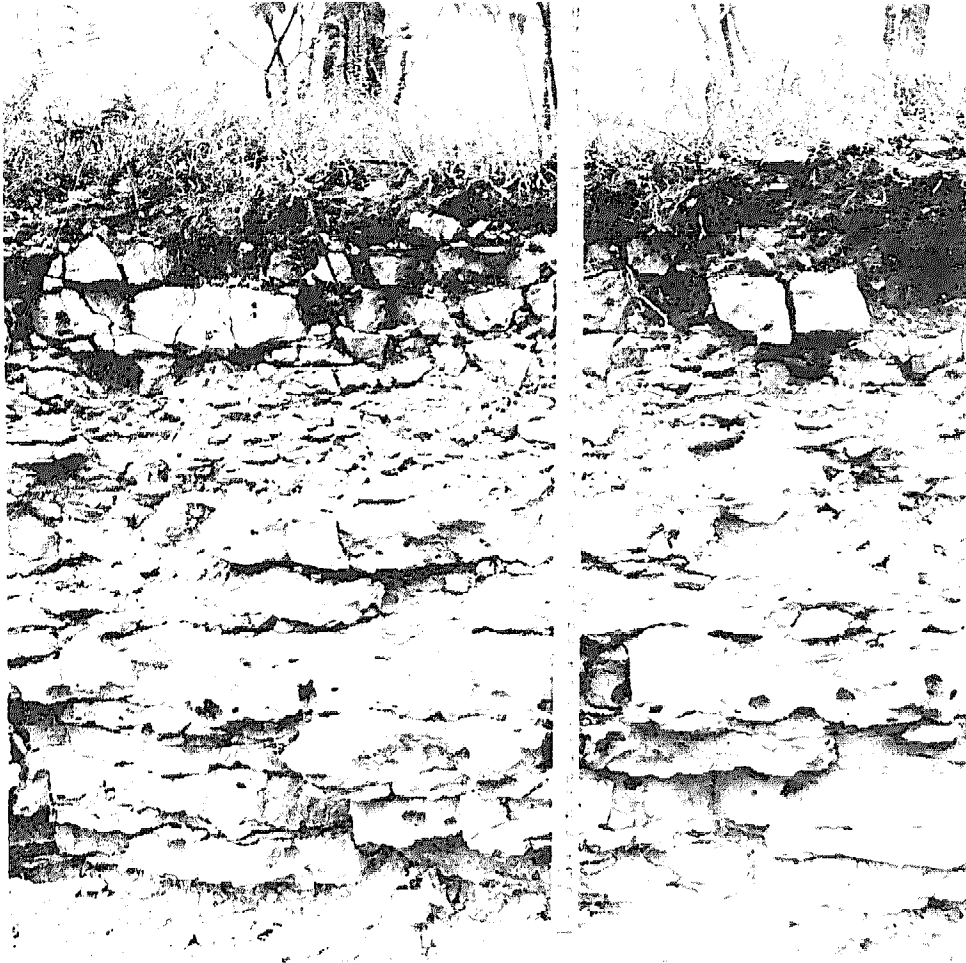

(Photo: U. S. Soil Conservation Service)

Fig. 1-2. A shallow soil, extremely limited in its capacity for supporting plant growth. Compare with Fig. 1-1.

tures so that the land's capability for various uses can be determined, the range or intensity of each feature is broken down into categories or degrees. For example, soil depth would be broken down into three classes of depth; namely, deep, moderately shallow, or shallow. These arbitrary classifications make it possible to group and evaluate all the land features and arrive at a land capability class. Those listed below are accepted generally throughout the country by conservationists although local variations must naturally be made. Soil and climatic conditions are too varied in such a large

country to permit the use of one standard classification of individual soil features. The land capability classification, to be discussed later, does lend itself to national use by taking into account all the variations.

Determine Depth of Soil Material

Depth of soil material means the combined depth of surface soil and favorable subsoil where the plant roots can live and do well in their job of getting food and water for the plant. Depth of topsoil, also important, is discussed under "Measure Degree of Erosion."

Normally 36 to 40 inches of soil material, of favorable texture and structure, has been found to provide sufficient food and water storage capacity for the growth of adapted crops (Fig. 1-1). Soils of lesser depth will usually be lacking in food and water storage capacities.

Presence of any layer in the soil which severely restricts or prevents thrifty root development and growth at less than 36 inches will limit the effective depth of a soil. Common restrictive layers are rock layers; dense chert layers; sand or gravel layers; hardpan, claypan, or siltpan layers.

Three classes of soil depth are suggested:

Deep—If the combined thickness of the favorable surface soil and subsoil is 36 inches or greater in depth.

Moderately Deep—If the presence of a limiting or restrictive layer occurs within 20 to 36 inches of the top of the soil.

Shallow—If the presence of a limiting or restrictive layer occurs at 20 inches or less in the soil.

Soil depth can be judged by digging in the soil with a soil auger or spade or by observing road cuts or gully

banks to determine the presence of any limiting layers. Soil depth determines the area which is favorable for the storage of plant food or water. For example, research investigations have indicated that a 12-inch layer of favorable soil material such as a silt loam or loam will hold about 2 inches of water. Additional studies indicate that a normal crop, such as corn large enough to shade the ground, in July and August will require about an inch of water per week. A loam soil only 18 inches deep would hold about 3 inches of water. This would, under average conditions, furnish moisture for the plant for only a 3-week period. If sufficient rain did not fall and enter the soil in this time the plant would shrivel and fail to grow.

Soil depth also is important in seedbed preparation and in construction of terraces and ponds; and it affects the kind of crops that can be grown.

Air and Water Movement in the Soil

A soil, to have favorable air and water relationship, must be able to take up water readily during periods of rain and dry out or warm up readily when the rain is over. It must hold ample moisture to supply the needs of the crop between rains and yet permit water to pass through the soil and prevent water logging and excess moisture. A soil with favorable air and water relationship, with a reasonable amount and distribution of rain, will not stay too wet nor become too dry.

This relationship or exchange of air and water in the soil is known as the air and water movement. It has great effect on the kind of crops that can be grown, how soon the soil can be worked, benefits that can be expected from fertilizers, and the delivery of food and water to the plant by the plant roots during periods of wetness and dryness.

The air and water behavior in soils is influenced by

many things, some of which are the texture and structure of the soil, the degree of density or porosity of the soil, and the thickness of the various layers.

Observe Subsoil Color

One of the best clues, however, to soil, air and water relationship is the color of the subsoil. Just as a plow share will oxidize or rust when exposed to intermittent wetting and drying so will a soil oxidize under favorable air and water movements. A soil having a moderate air and water behavior has good aeration yet ample moisture for favorable chemical reaction. A well oxidized soil has bright colors of red, yellow or brown in the subsoil. A soil with too much water and not enough air will not oxidize well, the colors will be dull or gray, and frequently mixed or mottled colors of gray, black, yellow and brown will occur.

For general purposes, most soils can be grouped into one of the following air and water behavior conditions:

Rapid—(which may be subdivided into moderately rapid, rapid, or very rapid in some areas)—This means that water and air movement is slightly faster than is desirable. Water moves through the soil too fast and the soil does not hold enough moisture for the most favorable soil functions. Air will replace the water and the soil will be droughty. These soils normally will allow at least 2.5 inches of water to pass through them in one hour. Oxidation will have been very thorough under this condition and subsoil colors will be bright even though air and water movement is too rapid for best soil functioning.

Moderate—This is the most favorable condition of air and water behavior—just right for normal

soil functions. The soil allows an exchange and movement of air and water which is neither too great nor too little. This permits adequate passage of water for quick warming-up of the soil, yet the soil retains enough moisture to withstand reasonable periods with no rain. Moderate water movement is considered to be between .8 and 2.5 inches per hour. If there is free drainage underneath, this soil has a well oxidized subsoil as indicated by a bright color such as red, yellow, or brown throughout the subsoil.

Moderately Slow—Water moves through the soil just a little slower than is desirable for best results. The soil holds enough moisture normally for most soil functions but is inclined to be slightly wet and cold natured in the damp spring seasons or following periods of heavy rainfall. Moderately slow water movement is measured between .2 and .8 inches per hour.

The subsoil in this case is less well oxidized and the colors will be bright in the upper part with dull gray or mixed colors usually accompanied by heavier texture in the lower subsoil.

Slow—Soil characteristics are such that water and air move through the soil at a slow rate and the soil remains quite wet following the rainy periods and dries out rather slowly. Timely seasonable operations are often delayed and the most favorable plant growth may be delayed because of the wetness and cold nature of the soil. Slow water movement is between .05 and .2 inches per hour.

This condition is characterized by dull gray or mixed and mottled dull colors throughout all the subsoil.

Very Slow—Water movement is so slow that suf-

ficient air cannot get into the soil and it remains wet and water-logged for rather lengthy periods. Such soils are not well adapted to some crops and normally remain wet in the wet seasons. They store insufficient available moisture for the plant and are droughty in dry periods. Water movement in these soils generally is less than .05 inches per hour.

Soils of this kind have gray color in the lower part of the surface soil—often called a gray layer—and the subsoil is dull gray, mottled and usually very heavy.

It is well to keep in mind that poor oxidation and gray colors reflect the natural air and water condition in a soil before any drainage may have been done. If such soils can be drained artificially the air and water movement will be improved quickly but subsoil colors change very slowly. Therefore, the determination of air and water behavior in soils that have been drained can be judged more accurately by a careful study of subsoil structure and texture rather than by color.

Color of Surface Soil

In a large part of the country, particularly in the humid area, a dark colored surface soil usually is an indication of the inherent productivity. This darkness indicates that over the centuries of soil formation, grass roots, stems and other organic materials have decayed and become a part of the soil. The black soil of the Corn Belt, where prairie grasses for centuries grew and died to add their substance to the soil, is a good example.

Darkness of topsoil color is not a clue to productivity in desert soils where little or no organic matter was returned to the soil throughout the ages. Also, even in

the humid area the minerals from which the soil is derived have a lot to do with inherent fertility.

But even so, surface soil color is an important clue left by Nature that helps us determine the inherent fertility of the soil and should not be overlooked in those areas where it applies. A field may have been abused by past misuse and as a result the present fertility may not be equal to the inherent or native fertility. But the color of the surface will give a good indication of how a soil produced in the past and an indication of needed treatment to assure future production.

In judging soil color these three categories are suggested:

Dark—This includes the black and dark brown colored surface soils which usually indicate a relatively high inherent fertility.

Moderately Dark—This includes the dark gray, grayish brown and the light brown surface soils indicating a moderate inherent fertility level.

Light—This includes the brownish-gray, gray, or light gray surface soils and indicates a low or very low inherent fertility level.

Surface soil color can be determined merely by looking at a handful of the soil when it is moist.

Heavy cropping in the past may have depleted the available supply of plant nutrients to a low level. Unfortunately we cannot determine the present level of plant nutrients by merely looking at or feeling the soil. After judging the land's inherent fertility by noting the color, soil tests will help in planning a conservation program by indicating what kind and how much fertilizer to apply.

Determine Texture of the Surface Soil

Texture of the surface soil refers to the size of the soil particles. This is important in its influence on a soil's ability to take up moisture, to dry out, the ease of tillage, and the character of the seedbed—where the young plant must start its growth. For determining land capability the surface soil texture may be divided into four general categories. (Some additional ones may be necessary in some soil areas.)

Medium—A good favorable mixture of sand, silt and clay, neither too heavy nor too light. (Usually a loam or a silt loam.)

Light—A surface texture that is a little too sandy. It does not hold moisture well and is subject to rapid temperature changes. (Usually a sandy loam or very fine sand.)

Heavy—A surface texture with so much clay in the surface soil that it is sticky and gumbo-like. It often is too wet to work and remains hard and cloddy when dry. (Usually a clay or silty clay.)

Very Light—A texture that is very sandy and coarse and will not hold together. Such a soil cannot hold sufficient water or plant food and is subject to blowing. (Usually a sand or coarse sand.)

Test Texture with Fingers

Surface texture can be determined by rubbing a portion of the surface soil between the fingers. If it is smooth and fluffy, holds together well but breaks up easily without too much coarse sand present, it has medium texture.

A light textured soil feels gritty and has considerable sand present, falls apart readily and can be pressed into a firm ball only with difficulty.

A heavy textured soil feels sticky and heavy, ribbons out between the fingers like toothpaste when wet or breaks into small cubes when dry.

A very light textured soil is very coarse and gritty and the individual particles of sand can be easily seen; it will not bind together into a ball when pressed or does not dirty the fingers when rubbed between them.

Measure Steepness of Slope

Slope is important because of its influence on the speed with which water runs off a field and the amount of soil that washes off with the water. Slope also affects the use of farm machinery. Some fields are so steep that cultivation is impossible even though the soil is excellent.

For classifying the slope of the land the following divisions may be used:

Nearly Level—Land that is flat or very nearly so and has very little slope—usually less than two feet fall for every 100 foot horizontal distance.

Gently Sloping—Land that slopes very gently and usually has no abrupt changes—usually 3 or 4 feet fall per 100 foot distance.

Moderately Sloping—Land that has considerable slope and usually some irregularity—normally 7 to 8 feet fall per 100 foot distance.

Strongly Sloping—Land with slopes that are quite strong, usually with considerable irregularity—about 14 to 15 feet fall to each 100 feet.

Steep—Land that breaks sharply and has steep slopes—usually around 18 to 20 feet fall in 100 feet of distance.

Very Steep—Land that slopes very abruptly and is

very steep—around 25 to 35 feet fall, or more, in each 100 foot distance.

Slope classifications will vary from these in some parts of the country due to different soil conditions, climate and cropping practices.

Also, the length of the slope is an important factor not considered here.

Slope is determined by the use of various forms of levels. (See Chapter III.)

Measure Degree of Erosion

Topsoil is generally the richest part of the soil. When the topsoil erodes away by washing or blowing, not only precious soil is lost but also many valuable pounds of plant food. The amount of topsoil remaining to be farmed is very important in determining the practices needed to conserve the land.

Depth of topsoil can be measured by digging into the surface soil or observing the furrow slice behind the plow. A convenient grouping of erosion classes could be made as follows:

No Apparent Erosion—Nearly all the original topsoil remains and there is no apparent evidence of erosion.

Moderate Erosion—Top 6 or 7 inches is mostly original topsoil, occasional subsoil spots exposed on the field.

Severe Erosion—Top 6 or 7 inches is mixed topsoil and subsoil, numerous subsoil spots exposed on the field.

Very Severe Erosion—Topsoil is nearly all gone and the top 6 or 7 inches is mostly subsoil.

Very Severely Gullied—Topsoil nearly all gone and numerous gullies occur on the field.

The six land features discussed here are probably the most important from an over-all standpoint. In certain localities some others may be more significant. For example, the presence of alkali may overshadow all other characteristics in an irrigated area; or the danger of overflow or depth to water table can be of equal importance in other areas. The important point is that the physical land characteristics limit what can be done with a given area of land. Knowing these characteristics in your locality is absolutely essential to the planning for correct land use and the supplementary practices that go toward making a farm conservation plan.

Classifying Land According to Its Capability

After studying and appraising the different land features, we still have not arrived at the place where we can say how a field should be used and what treatment it needs to keep it good permanently. We need a measuring stick that will enable us to consider all of these land features in one bundle—to judge each different combination of land features so that the field can be studied and treated as a unit.

A standard land capability classification system is now in general use throughout the United States. It makes use of all the land features known to be significant.

In this system the many different kinds of land are grouped into eight land capability classes, each class having the same meaning in all parts of the United States.

Cropland vs. Non-cropland

To begin with, all land is classified into two broad groups: (1) land suited for cropland, and (2) land

sited only for permanent vegetation. Each of these is subdivided into four general classes. The four subdivisions indicate the intensity of the land hazards present under each type of use.

Classes I, II and III include all land that is suited for regular cultivation, and Class IV the land that can be safely cultivated only occasionally, that is, in a limited way. Classes V, VI and VII include the land that is not suited for cultivation but is suited for pasture and woodland. Class VIII is the land that is not suited for cultivation, pasture or woodland. Some of it is good for recreation.

These classes are designated by different colors on maps. The colors are standard throughout the nation and make it possible to quickly interpret the information on the land capability maps.

Definitions of the Land Capability Classes

Here are descriptions of the eight land capability classes:

Class I is very good land from all points of view. It is nearly level and does not wash or blow readily. The soil is deep and easy to work. It holds water well and is at least fairly well supplied with plant nutrients. You can use it safely in almost any way you choose. Of course, it should be managed so that a good supply of plant nutrients and good physical conditions are maintained. This class is designated on a land capability map by a light green color. (Figs. 1-3 and 1-4.)

Class II is good land from every standpoint, but certain physical conditions make it not quite so good as Class I. (Fig. 1-5.) The slope may be just enough to create an erosion hazard. Some Class II land is naturally wet and drains slowly. Some has not quite as good water-holding capacity as Class I land and is slightly droughty. Each of these deficiencies either



(Photo: U. S. Soil Conservation Service)

Fig. 1-3. Class I land in Indiana—highly productive, well-drained, and nearly level. It can be cultivated safely and permanently without special soil conservation practices.

limits the use of the land to some extent or requires some special attention year after year. This class is colored yellow on the map.

Since Class II land has some moderate, natural use limitation, some special treatment is called for, such as easily applied conservation practices like contouring, simple water management, crop rotating, and the use of cover crops and fertilizers.

Class III is moderately good land for cultivation. It is more limited in use than Class II land by reason of one or more natural features. It can be used regularly for crops but, because of these natural restrictions, in-

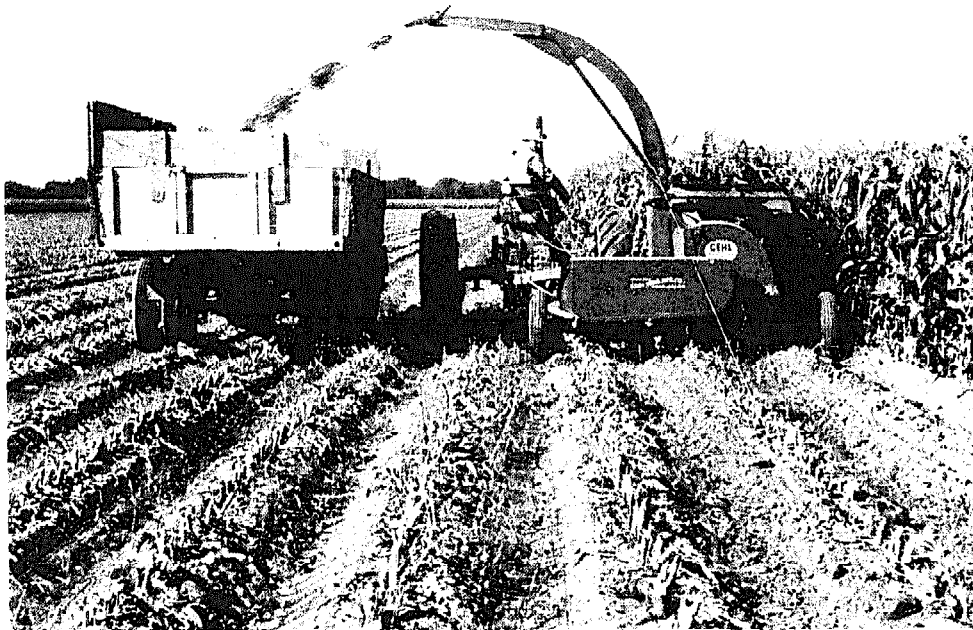

(Photo: U. S. Soil Conservation Service)

Fig. 1-4. Harvesting corn for silage on Class I land in an irrigated area in Nebraska.



(Photo: U. S. Soil Conservation Service)

Fig. 1-5. Class II land in Ohio. Contour strips are needed here to prevent erosion.

tensive treatment of some kind is called for. Some Class III land is moderately sloping and must have intensive use of erosion-control practices to control erosion if cropped in a regular rotation. (Fig. 1-6.) An-



(Photo: U. S. Soil Conservation Service)

Fig. 1-6. Class III land in Virginia protected with contour strip cropping and a 4-year rotation.

other variation of Class III land is that which may be poorly drained and requires drainage. All Class III land is colored red on the map.

Class IV land is good enough for occasional cultivation under careful management, but it is not suited for regular production of cultivated crops. A large part of it is too steep for regular cultivation primarily because of the danger of erosion. Some may be flat, sandy lands which are droughty. Generally speaking, Class



(Photo: U. S. Soil Conservation Service)

Fig. 1-7. Class IV land in Georgia protected by a crop of sericea lespedeza.



(Photo: U. S. Soil Conservation Service)

Fig. 1-8. Class V land in Texas. This land is flat but is not suited to cultivation. It can be used for permanent vegetation.

IV land can be cultivated safely, perhaps one year in six; in the other years its best use is for pasture or hay. This class is indicated by a blue color. (Fig. 1-7.)

Class V land is nearly level and not subject to erosion. Because of wetness, climate, or some permanent obstruction like stones and boulders, it is not suited for cultivation. The soil is deep, however, and the land has few limitations of any kind for grazing or for forestry use. This class is colored dark green on the map. (Fig. 1-8.)

Class VI land is not suitable for any cultivation, and it is limited somewhat for grazing or forestry by such features as shallow soil, steep slopes, or excessive stream bank cutting that cannot be corrected to permit



(Photo: U. S. Soil Conservation Service)

Fig. 1-9. An example of Class VI land in West Virginia. It needs special care and management to be used for permanent vegetation.

use for crops. This class is designated by an orange color. (Fig. 1-9.)

Class VII land not only is unsuited for cultivation but has severe limitations for use for grazing or for forestry. It requires extreme care to prevent erosion. (Fig. 1-10.) In rough areas its use for either grazing



(Photo: U. S. Soil Conservation Service)

Fig. 1-10. Woods on very steep and stony Class VII land in Vermont. This is good use for Class VII land.

or woodland requires special care. A brown color designates this class.

Class VIII land is suited only for wildlife or recreation purposes. Usually it is extremely dry, rough, steep, stony, sandy, wet, or severely eroded. (Fig. 1-11.) Class VIII land is colored purple on capability maps.



(Photo: U. S. Soil Conservation Service)

Fig. 1-11. Class VIII land in the Badlands of South Dakota. Not suitable for any agricultural use.

Chapter

II

USING CROPPING SYSTEMS THAT CONSERVE SOIL AND WATER

While correct land use is probably the most important single step in conservation farming, a cropping system that will maintain good soil condition is a basic conservation practice on cropland. A conservation cropping system is the growing of crops in combination with the needed cultural and management practices such as terracing, irrigation, and drainage for each kind of soil to maintain good soil condition.

Maintaining proper soil tilth means making use of crop residues, proper tillage practices, green manure and cover crops, and grasses and legumes. It also means using commercial fertilizers and where soil tests indicate, it means using lime.

For many years, crop rotations that include grasses and legumes have been the standard system for doing these things, and on much of our land, particularly sloping land, crop rotations may continue to be the best way. A crop rotation is simply the growing of different crops in recurring succession on the same land.



(Photo: U. S. Soil Conservation Service)

Fig. 2-1. Excellent tilth—soil sample from bluegrass sod in an undisturbed fence row.

virgin land, it looked like the soil in excellent tilth. Today it is dense, compact, and heavy to lift. The top 7 inches of an acre of this soil weighs about 225 tons more now than it did under virgin conditions. Studies

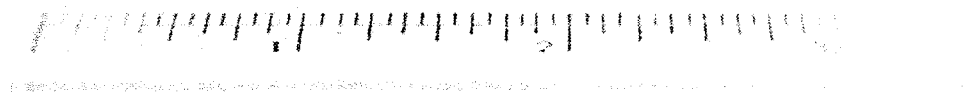
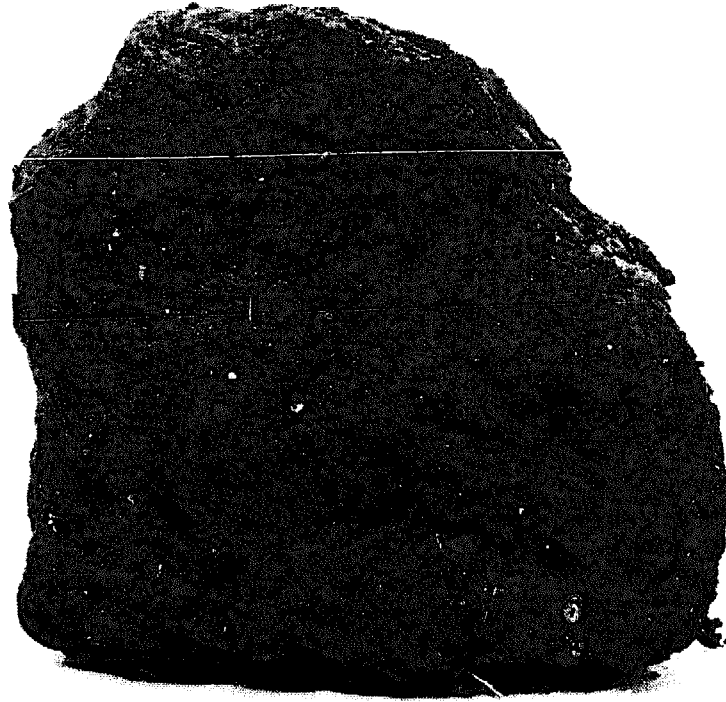

(Photo: U. S. Soil Conservation Service)

Fig. 2-2. Poor tilth—soil sample from the plow layer of a field farmed to corn, corn, corn, soybean rotation for more than 40 years.

show that only one-fifth inch of water will pass through the plow layer in one hour. This is not nearly fast enough to soak up the water that falls during most rainstorms.

Notice the difference between the soil in good tilth

and the one in poor tilth. The soil in good tilth is more crumbly and will soak up water faster. An acre, to plow depth, is about 90 tons lighter in weight. Water will pass through the plow layer at the rate of 3.2

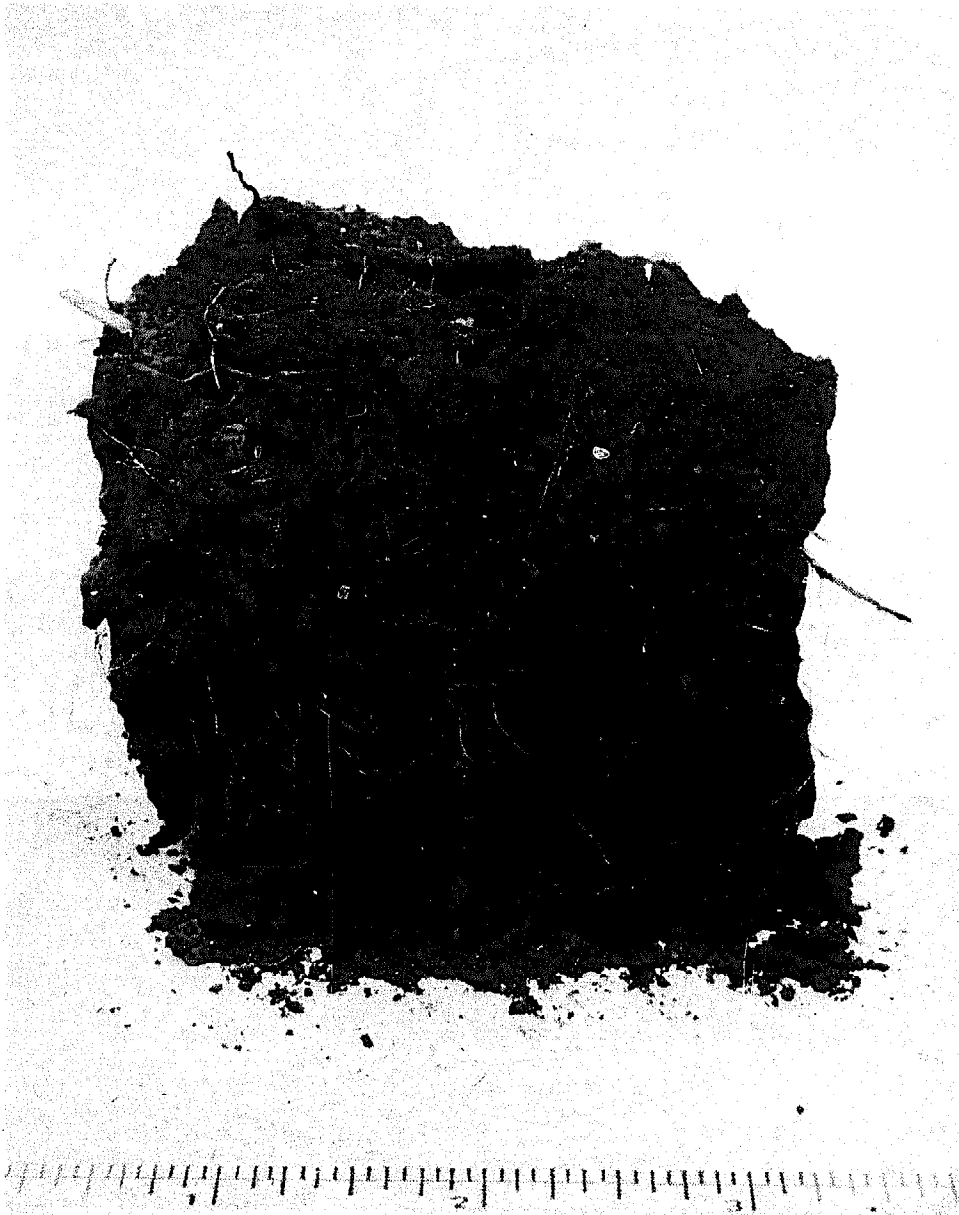

(Photo: U. S. Soil Conservation Service)

Fig. 2-3. Good tilth—soil sample from plow layer of a field farmed to corn, oats, clover, wheat (clover) rotation for more than 40 years.

inches per hour. This is 16 times faster than through the soil in poor tilth. The soil in good tilth will also hold about 17 per cent more water which is available for plant growth. This additional water is especially important during dry periods in summer.

In the soil in excellent tilth it is easy to see the soil granules and the general loose condition. A cubic foot of this soil weighs about 69 pounds as compared with 80 pounds for the soil in good tilth (from the well-managed field) and 87 pounds for the soil in poor tilth (from the severely cropped field). Studies show that water will pass through the top 7 inches of the soil in excellent tilth at the rate of 8.4 inches per hour, or 44 times faster than through the soil in poor tilth.

One reason that crop rotations help maintain good tilth is that they include a grass and legume mixture. Another reason is that they reduce the amount of soil stirring simply because the land is in sod crops a part of the time as compared to being subjected to working necessary to grow a cultivated row crop. If conservation is to be achieved, other things being equal, the amount of time the land needs to be in grass and legumes will depend on the erosion hazards present.

Let's look at some of the early research on the effectiveness of rotations. How well rotations help in erosion control is indicated in Table 2-1, from Wisconsin Bulletin 452. Note the effect a crop of hay has on the amount of soil loss on a 16 per cent slope, where all the plots were identical. Where corn was grown after one year of hay, 42 tons of soil per acre were lost. With corn after corn following hay, the loss was 60 tons. Corn continuously lost 89 tons, so the residual effect of the hay was felt even in the second year of corn. These losses are, of course, too high but the comparisons are valuable for the lesson they give regarding the use of grasses in rotations.

TABLE 2-1. Soil losses from plots 72 feet long on a slope of 16% under various cropping systems at La Crosse, Wis.

Crop Sequence	Average Soil Loss Tons Per Acre Per Year
1. Continuous corn for 6 years.....	89
2. Corn after 1 year of corn after hay.....	60
3. Corn after 2 years of corn after hay.....	72
4. Corn after soybeans.....	66
5. Corn after 1 year of hay.....	42
6. Corn after 6 years of hay.....	28
7. Corn after bluegrass sod.....	18
8. Soybeans after soybeans after 6 years alfalfa-timothy	64
9. Barley after corn after 1 year of hay.....	24
10. Barley after corn after 6 years of hay.....	10
11. First year of hay.....	0.75
12. Second to sixth year of alfalfa-timothy hay.....	0.30
13. Bluegrass sod (clipped).....	0.20

(From Wisconsin Bulletin 452)

TABLE 2-2. Computed soil losses from plots 72 feet long on a 16% slope under various cropping systems at La Crosse, Wis.

Crop Sequence	Average Soil Loss Tons Per Acre Per Year
1. Corn Annually.....	89
2. Corn, Barley (Sweet clover).....	33
3. Corn, Barley, Hay.....	22
4. Corn, Soybeans, Barley, Hay, Hay, Hay.....	22
5. Corn, Corn, Barley, Hay, Hay, Hay.....	20
6. Corn, Barley, Hay, Hay.....	13
7. Corn, Barley, Hay, Hay, Hay.....	8
8. Corn, Barley, Hay, Hay, Hay, Hay.....	7
9. Corn, Barley, Hay, Hay, Hay, Hay, Pasture, Pasture	5
10. Corn, Barley, Hay, Hay, Hay, Hay, Hay, Hay, 4 yrs. Pasture.....	3

(From Wisconsin Bulletin 452)

Slope Helps Determine Cropping System

Table 2-2 makes comparisons of different cropping systems, also on the same soil and slope conditions.

Note that with a three-year rotation the annual soil loss was 22 tons compared with 89 tons for continuous corn. Just one additional year of hay reduced the loss to 13 tons. Note that it required a 12-year rotation (corn, barley, 6 years of hay and 4 years of pasture) to cut the soil loss to 3 tons a year, considered an allowable loss. Here is a lesson in land use. It is evident from these studies that on this soil, with the slope and other physical conditions present, the only safe use is continuous grass or hay. Even corn once in 12 years resulted in a 3-ton annual loss, probably the maximum loss that this soil can stand.

Reduce Length of Slope

Tables 2-3 and 2-4 show soil losses per acre on moderately eroded soils with different cropping systems but on different length slopes. This brings in another factor, the use of terracing as a supporting practice to reduce the length of slope; but it illustrates the significance of properly combining conservation practices on

TABLE 2-3. Expected soil losses in tons per acre per year from cropping systems on moderately eroded slopes. (72 foot length of slope)

Cropping System	Per Cent Slope							
	3	6	9	12	15	16	18	24
Corn Annually	5	12	22	44	76	89	117	242
Corn, Barley (Sweet clover)	2	4	8	16	28	33	44	90
Corn, Barley, Hay	1	3	6	11	19	22	29	60
Corn, Corn, Barley, 3 yrs. Hay	1	3	5	10	17	20	26	54
Corn, Barley, 2 yrs. Hay	1	2	3	6	11	13	17	35
Corn, Barley, 3 yrs. Hay	0.5	1	2	4	7	8	10	22
Corn, Barley, 4 yrs. Hay	0.5	1	2	3	6	7	9	19
Corn, Barley, 6 yrs. Hay & Pasture	0.5	1	1	2	3	5	7	14
Corn, Barley, 10 yrs. Hay & Pasture	0.2	0.5	1	1	2	3	4	8

Only the combinations of slope and rotation shown at the left of the heavy line will give satisfactory erosion control.

(From Wisconsin Bulletin 452)

TABLE 2-4. Estimated soil losses in tons per acre per year from cropping systems on moderately eroded slopes. (420 foot length of slope)

Cropping System	Per Cent Slope						
	3	6	9	12	15	18	24
Corn Annually -----	9	18	35	71	122	189	388
Corn, Barley (Sweet clover) -----	3.2	7	13	26	45	70	143
Corn, Barley, Hay -----	2	4	9	17	30	46	95
Corn, Corn, Barley, 3 yrs. Hay -----	2	4	8	16	27	42	86
Corn, Barley, 2 yrs. Hay -----	1	3	5	10	18	28	57
Corn, Barley, 3 yrs. Hay -----	1	2	3.2	6	11	17	35
Corn, Barley, 4 yrs. Hay -----	1	2	3	6	10	16	32
Corn, Barley, 6 yrs. Hay & Pasture	0.5	1	2	3	5	9	19
Corn, Barley, 10 yrs. Hay & Pasture	0.2	0.5	1	2	3	5	10

Only the combinations of slope and rotation shown at the left of the heavy line will give satisfactory erosion control.

(From Wisconsin Bulletin 452)

the field and the farm to bring about the desired result.

It should be kept in mind, regarding these tests, that the year the field was in corn all the stover, stalks, and corn were removed. If only the grain itself were removed and all the rest of the crop returned to the soil, and adequate amounts of commercial nitrogen added to decompose the crop residue, the results would be different. The method of crop production and the full utilization of its residue either in the form of manure or as direct residue, should be considered when we say that a crop is a good one or a poor one in the rotation so far as soil loss is concerned.

Figure 2-4 shows the effect of cropping system and slope on erosion on two soils in Missouri. According to Missouri Bulletin 518, "Cropping Systems for Soil Conservation," soil loss from bluegrass was almost zero. Erosion was reduced more than 80 per cent at both locations by using a rotation instead of continuous corn.

According to the authors of this bulletin, there are two principal reasons for the very effective reduction of erosion by crops in the rotation. One is soil cover.

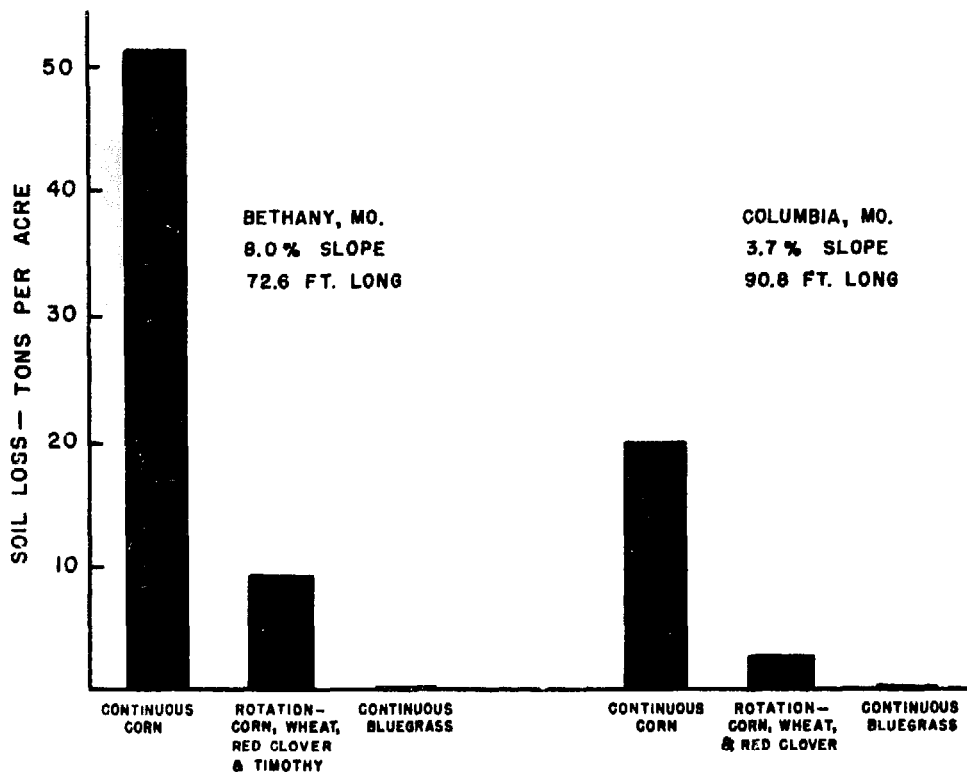

(From Missouri Bulletin 518)

Fig. 2-4. Effect of cropping system and slope on erosion.

Under continuous corn the land is bare almost the year round. With the rotation, it is covered almost the year round. The sod preceding the corn is not plowed until early April, and wheat follows the corn in October. Again, instead of wheat alone occupying the land for the wheat years, grass and clover growing in the wheat stubble reduce erosion materially. The grass and clover crops then occupy the land through a full year following and until the time of spring plowing for corn.

The other principal reasons for effective reduction of erosion by the rotation lies in the fact that soil loss is reduced while the cultivated crop is growing. In other words, land in corn which follows grass and clover loses considerably less soil than land in corn

following corn. This reduction can be attributed to the beneficial effects of a grass-legume sod in conditioning the soil to resist erosion.

There are other advantages of crop rotations, such as weed and insect control, not directly associated with soil conservation.

For a crop rotation to work most successfully there should be as many fields or combinations of fields as there are years in the rotation. Such an arrangement makes a balanced program for the farmer year after year. This also makes the rotation actually "rotate." Crops revolve from one field to another each year in an orderly sequence and it is possible to determine several years in advance what will be in any given field at a given time.

Some Examples of Rotations

The 3-year rotation of corn, grain, and meadow has been used for many years in the Corn Belt. It is simple, easy to establish, and provides a high percentage of corn and small grain crops. However, it is doubtful if this could be considered a soil-building rotation except on gently rolling or nearly level land. The care in management of the residues, and use of fertilizers and lime, would help make up the difference.

The addition of a year of meadow making a rotation of corn, grain, and two years of meadow, provides a rotation adapted to a wide range of conditions. The two consecutive years of grass and legumes give this rotation an advantage over the 3-year rotation in maintaining soil tilth. With ordinary use of crops and crop residues, it will provide sufficient use of nitrogen and organic matter.

Cotton, wheat, lespedeza, and corn, cotton, oats, followed by one or more years of fescue-clover are

examples of sod-based rotations that have been coming into common use in the South.

Rotations of potatoes with timothy or the 3-year rotation of potatoes, oats, and red clover are used in New England.

Rotations of sugar beets, field beans, potatoes, and barley with several years of alfalfa are common on the irrigated lands of the West.

Success in the use of sod-based rotations depends on producing a good stand of a vigorously growing sod crop. It is important that you meet the needs of the legume, or legume-grass mixture for lime, phosphate, and potash. No rotation, however good in theory, can result in high yields if mineral nutrients are lacking. And on sloping land, where erosion is a problem, the proportion of sod relative to row crops should be high and erosion-control practices such as terraces, contouring, and stripcropping should be used.

Monoculture

There are advantages, however, of growing the same crop year after year, providing, of course, that the soil does not erode or otherwise deteriorate, and insects and soil-borne diseases can be controlled. This is known as monoculture. If different kinds of soil exist on a general farm, a monoculture system may permit each crop to be grown on the best suited soil. Thus, the steep soils where erosion is a hazard can be kept in a close-growing forage crop, while the intertilled row crops occupy the better soils with gentle slopes all the time. Slowly drained areas can be used continuously for crops that do not require early spring field operations; droughty soils can be used for drought-resistant crops, such as grain sorghums or winter small grains.

The fertility level of the soil can be adjusted to fit

one crop more readily than it can be adjusted to fit all crops in the rotation. In order to grow alfalfa, for example, the soil may need considerable lime, but it is not necessary to use this much lime to grow corn or small grain. In order to grow good yields of corn a high level of nitrogen is required. A residue of available nitrogen will be left after the corn is harvested; that is an advantage when corn follows corn, but it may cause lodging when small grain follows corn.

Systems based on continuous cropping generally offer greater flexibility in planning the cropping system to meet year-to-year changes in need for various crops. Part of the acreage can be shifted from one crop to another without upsetting the cropping plan for the whole farm.

Some Problems with Monoculture

The requirements for successful monoculture are stricter and demand greater management skill than do the requirements for successful use of sod-based rotations.

Nitrogen—The entire nitrogen requirement of the nonlegume crops must be met with nitrogen from fertilizers or farmyard manure.

Erosion—Successful monoculture requires close attention to erosion control, fertility, full use of residues, and diseases and insects that live in the soil, except for the special case of perennial sod. Problems of soil structure may become severe when you grow crops that require frequent tillage operations and return little organic residue to the soil.

The exact kind of soil that will stay in satisfactory physical condition under continuous cropping with each of the different crops is not known. The best course for a farmer to follow is probably

to watch the water relationships of the soil. If he sees a growing tendency for water to stay ponded on the surface or to run off more readily from sloping areas, the soil management system should be changed to provide more organic matter return to the soil, less frequent tillage, and perhaps more deep-rooted crops. Poor physical condition in the soil will be more evident in seasons that are too wet or too dry.

Increased Dependency on Chemicals—Users of monoculture will be completely dependent on chemical insecticides, disease-resistant varieties of plants, soil fumigation, and similar methods of controlling insects, plant diseases, and other pests. The severity of this problem varies from crop to crop, from one locality to another, and even from time to time.

Some weeds are harder to control in some crops than in others. Thus, changing the crop makes it easier to control them. But this is not true of all weeds. The control of weeds is simplified in some instances by keeping the same crop on the same field year after year. However, it is safe to say that the rapid advances in the use of chemical herbicides have helped solve many weed problems. In many instances, these herbicides remove weeds as a factor in planning a cropping system.

Continuous Row Crops

Scientists at Iowa State University point out that a decline in soil organic matter and soil structure has occurred under intensive cultivation. But most of the studies that brought this out were under conditions of low fertility, and consequently, low yields. In growing corn today, with adequate fertility and high yields, three to four tons per acre of crop residue are produced,

most of which is returned to the soil. This is about equal to the amount of organic matter returned in any cropping system. They conclude, therefore, that there is no reason to believe that the rate of decline in soil organic matter under continuous corn will be significantly greater than under most other systems. Highly fertilized continuous corn, as well as some rotation systems, may increase soil organic matter in soils which have a low level at the start.

They point out, however, that continuous corn should not be tried except on land that is level or nearly so, where the soils are deep and permeable; heavy applications of nitrogen and other fertilizers must be used, and all corn stalks must be shredded and left on the surface over the winter and spring before working back into the soil. Insecticides and herbicides will be needed. In short, it takes a better farmer to grow continuous corn than rotation corn.

One-year Cropping Systems

It is possible to alternate a winter crop with a summer crop and thereby eliminate some of the troubles that arise from a single crop. A close-growing winter crop like rye, ryegrass, vetch, or crimson clover alternates with a summer row crop like corn, cotton or tobacco. The winter crop is not harvested but is turned under for green manure. This system protects the land against erosion better than the single summer crop.

Another 1-year system with two crops consists of winter grain followed by annual lespedeza. Here the winter grain is the harvested crop, and the lespedeza contributes to the system primarily through its effect in maintaining available nitrogen in the soil.

In the Southern States, winter grain and soybeans, both crops being harvested for seed, are a promising 1-year, 2-crop system. Similar systems found in irri-

gated regions of the Southwest include winter grain and cotton.

An important fact to keep in mind concerning these 2-crop annual sequences is that there must be enough water for both crops. The use of these systems is confined, therefore, to the more humid states and to irrigated areas with long warm seasons.

Cropping System Based on Many Factors

In planning a cropping system for a farm or field the pattern of different kinds of soil must be considered. If the soil is quite uniform and is subject to erosion, probably a regular rotation should be used. On the other hand, if the farmer has several different kinds of soil, a monoculture system with each crop grown continuously on the soil where it is best adapted may be most satisfactory.

Also, the nature of the crops to be grown is important in making this choice. Some forage crops are easy to establish and can be used in fairly short rotations. If the preferred forage crop is rather slow to establish, continuous use of the field for this same crop may be best.

On the better soils a choice can usually be made of many systems. As the soil becomes steeper, or has poorer physical properties, or moisture becomes more of a limiting factor, or any other feature becomes less desirable, the number of systems from which to make a selection becomes fewer.

Chapter

III

ENGINEERING INSTRUMENTS

To plan and establish all mechanical practices used in soil and water conservation work requires information regarding the relative elevation of points on the earth's surface. For example, water will flow from one point to another in a terrace channel only if there is a difference in the elevation between the two points. Among other factors, we must know what the difference is in elevation in order to determine how fast the water will flow between the points.

A Suggested List of Activities Involving Approved Practices

1. Using Engineering Instruments
2. Caring for and Handling Surveying Instruments
3. Carrying the Instrument
4. Setting Up Instruments
5. Operating the Instrument
6. Chaining
7. Laying Out Work with a Dumpy or Wye Level
8. Staking Out a Contour Line
9. Staking Terraces
10. Running a Profile

1. Using Engineering Instruments

In order to be able to determine the differences in elevation necessary for laying out and applying such practices as contouring, strip cropping, terraces, diversions, ponds, farm drainage, land smoothing, irrigation and possibly some others, it is necessary to learn how to use certain engineering instruments. No conservationist can expect to achieve any measure of success in planning and applying a soil conservation plan without some knowledge and experience in the use and care of these instruments.

Only the simplest phases of engineering surveying can be covered in this book. For those students who would like to pursue the field further, it is suggested that U.S.D.A. Agriculture Handbook No. 135, **ENGINEERING HANDBOOK FOR SOIL CONSERVATIONISTS IN THE CORN BELT**, be studied. This handbook was prepared for the use of persons not technically trained in engineering. Yet it gives much basic information on engineering surveys and other phases of conservation engineering that will be useful in soil conservation work. More advanced work will require special training in engineering.

Kinds of Levels

The four kinds of levels commonly used include the engineer's wye and dumpy levels, and the two hand levels, the Locke and the Abney.

The dumpy level (Fig. 3-1) because of its sturdiness, convenience, and stability of adjustment, has largely superseded the wye level. The telescope on the dumpy level is rigidly attached to the frame.

The wye level (Fig. 3-2) is so called because the telescope rests in Y-shaped supports and can easily be removed.

The Locke hand level (Fig. 3-3) is used for rough

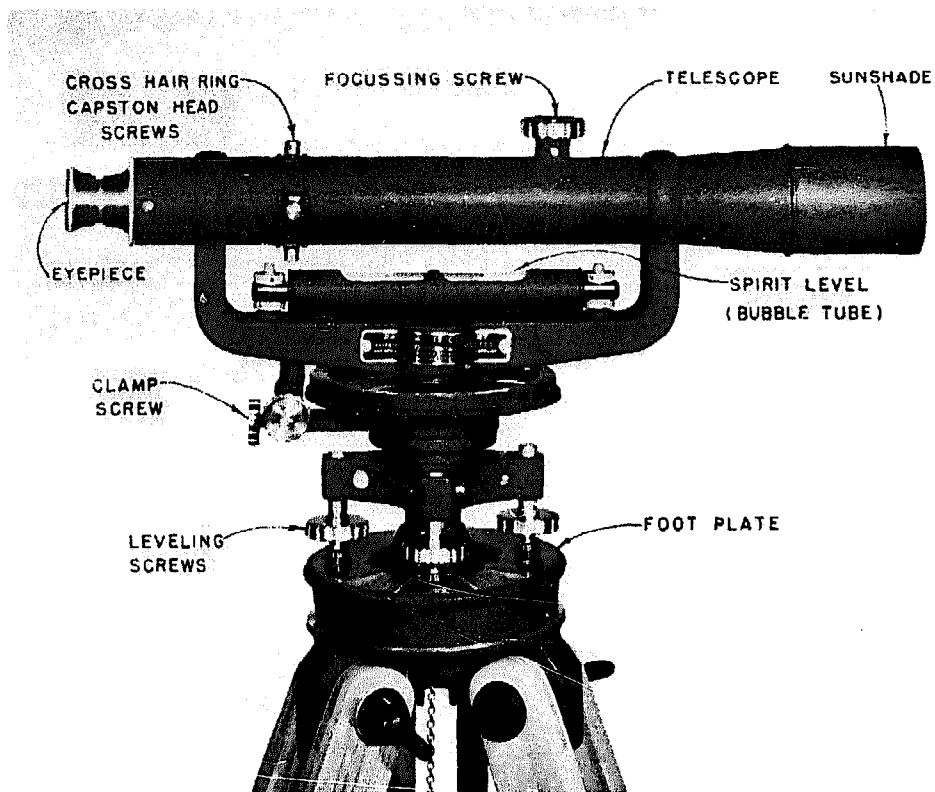

(Photo: The David White Company)

Fig. 3-1. Engineer's dumpy level.

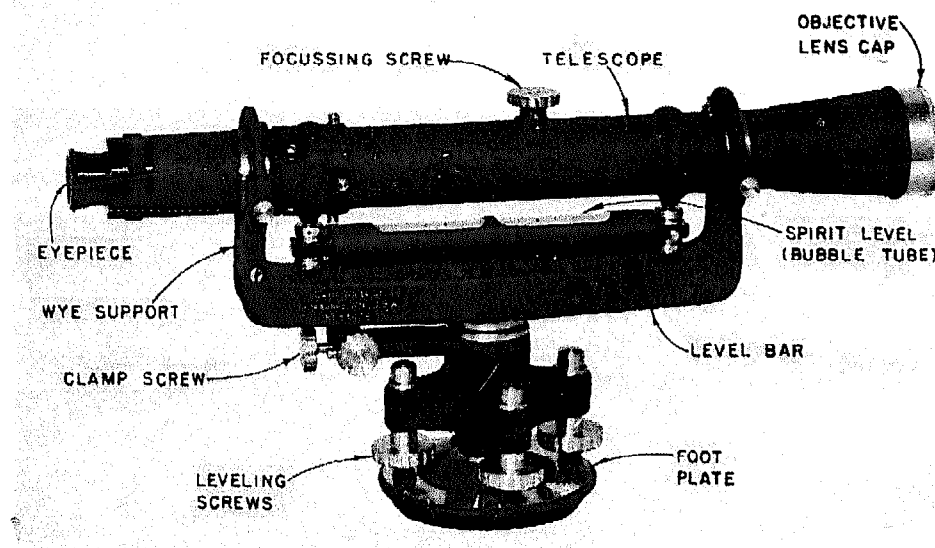

(Photo: The David White Company)

Fig. 3-2. Engineer's wye level.

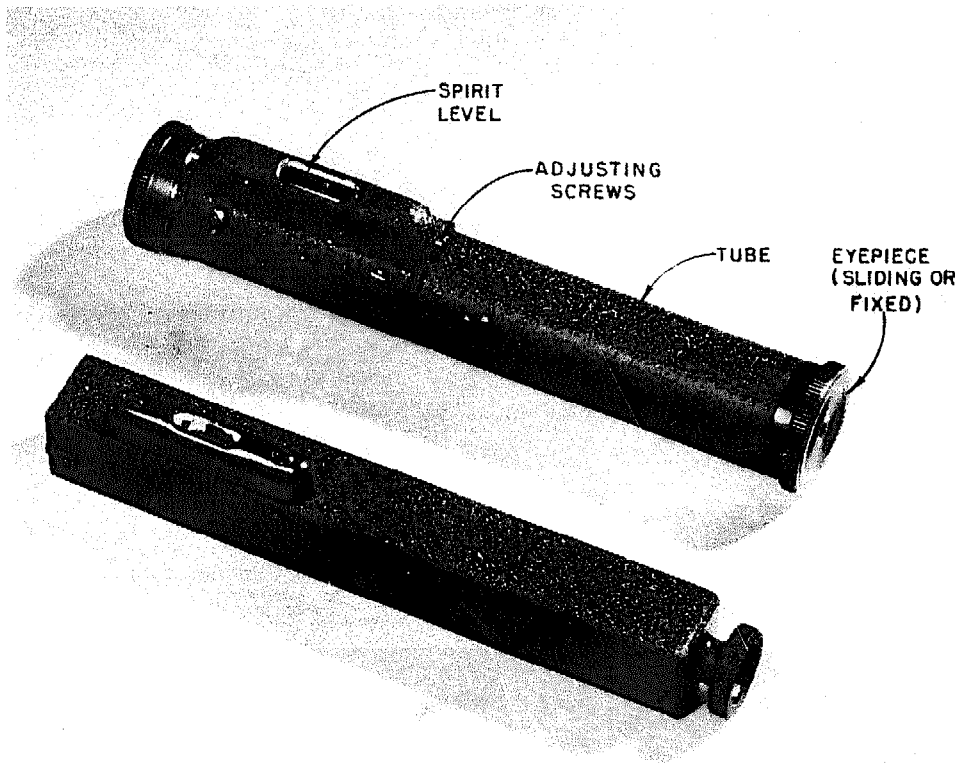

(Photo: The David White Company)

Fig. 3-3. Locke hand level.

measurements of differences in elevation. It is used by merely standing erect and sighting through the eyepiece, holding the tube in the hand, and moving the objective end up or down until the image of the spirit level bubble in the mirror is centered on the fixed crossed wire. The point where the line of sight in this position strikes the rod or other object is then noted. A fairly accurate line of levels may be carried with the hand level for a distance of 400 or 500 feet, provided the length of each sight is not over about 50 feet.

The hand level is satisfactory for laying out contour lines or strips in a strip cropping system. It cannot be used for terraces, diversions, drainage, ponds or other structures requiring exact specifications.

Hand levels can be used in "sizing up" a site for a pond, or for other such structures, and the fall for drainage preliminary to making the regular survey.

Steepness of slopes can be measured by use of the Locke hand level by the following procedure:

Step 1: Determine the height (H) of your eye above the ground at your feet when standing erect. This height can be determined by direct measurement. Or it can be obtained approximately by subtracting four-tenths (0.4) of a foot from your height. (Most engineering measurements are in feet and tenths of feet rather than in feet and inches.)

Step 2: Assume (H) is 5.3 feet. Stand erect, face toward the slope along a given line, and sight the hand level with the bubble level on an easily distinguishable object on the surface of the ground.

Step 3: Pace the distance from the point occupied in Step 2 along the given line to the object observed in Step 2. Let us assume that the paced distance is 60 feet. (See instructions for pacing, later in this chapter.)

Step 4: Determine the vertical rise per 100 feet. This is obtained by multiplying the eye height (H) by 100 and dividing by the slope distance paced.

$$\frac{5.3 \times 100}{60} = 8.8 \text{ ft. vertical rise per 100 feet or } 8.8\% \text{ slope.}$$

The Abney hand level (Fig. 3-4) is constructed and functions in the same manner as the Locke hand level, except that it is equipped with a graduated arc for reading per cent of slope. The spirit level is attached to the arc on the Abney level. The user sights through the tube and fixes the line of sight so that it will be parallel to the slope on which it is desired to measure the per cent of slope. This is done by sighting on another person's eyes, chin, hat, or any predetermined feature the same height as your eye, or by kneeling and sighting

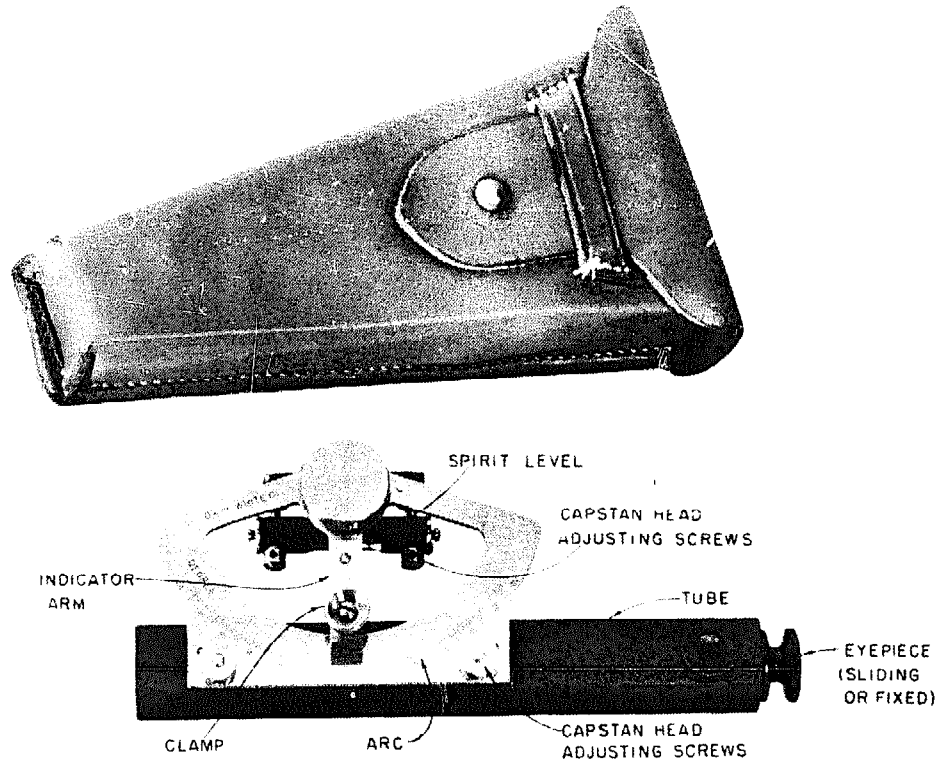

(Photo: The David White Company)

Fig. 3-4. Abney hand level.

on a fence wire which is the same height as the eye while in a kneeling position. The indicator is then adjusted with the free hand until the image of the spirit level bubble is centered on the cross wire. The indicator is then clamped and the per cent of slope read.

The Abney level may be used in the same manner as the Locke hand level for running a level line if the indicator is clamped at the zero reading.

Both types of hand levels may be equipped with a sliding eyepiece. When the sliding eyepiece is extended, it has the effect of lengthening the line of sight within the tube, thus increasing the accuracy of observations.

Level Rods and Accessories

There are many different kinds of level rods. One of

the most common is the Philadelphia-type rod which is made in two sections and is equipped with clamp screws (Fig. 3-5). It is about 7 feet long and extends to



(Photo: The Keuffel and Esser Company)

Fig. 3-5. Philadelphia level rod.

13 feet. It is graduated in feet, tenths, and hundredths. It may be equipped with round or oval target, or may be used without target.

2. Caring for and Handling Surveying Instruments

Surveying instruments are precise, delicate pieces of equipment and are expensive. Their cost alone justifies proper care and protection. Good care is also necessary in order that the instruments can be kept in accurate adjustment and operating condition for survey purposes.

Keep Instruments in Carrying Case

In hauling instruments in vehicles always keep the instrument in its carrying case. The level should be kept in the cab of the vehicle, if a truck or pickup is used, preferably in the seat. It should be subject to as little vibration as possible.

Protect Against Weather

Level rods should be in cases and carried where they will be protected from weather and where they will not have other material piled on top of them or against them. Tripods should be similarly protected from damage and the weather.

Mounting the Level on the Tripod

The first step in mounting the level is to set up the tripod (Fig. 3-6). Remove the tripod cap and place it in the instrument box to prevent it from being lost. The wing nuts on the tripod should be tightened just enough so that when a tripod leg is elevated, it will drop gradually of its own weight.

Use Fingers to Adjust

The level should be carefully removed from the instrument case. It is better to place the fingers beneath the horizontal bar in handling the instrument. See that the instrument is securely attached to the tripod. When screwing the instrument base on the tripod, it should first be turned in the reverse direction until a slight jar is felt, indicating that the threads are properly engaged. It should then be screwed on slowly until it refuses to turn further, but not so tightly engaged that it will be difficult to unscrew when the instrument is to be dismantled.

Remove the object glass cap and place it in the instrument case for safe keeping and attach the sunshade to the telescope. Always attach the sunshade regardless of the weather.

3. Carrying the Instrument

The instrument is usually carried assembled to the field on the shoulder. But in passing through doors,

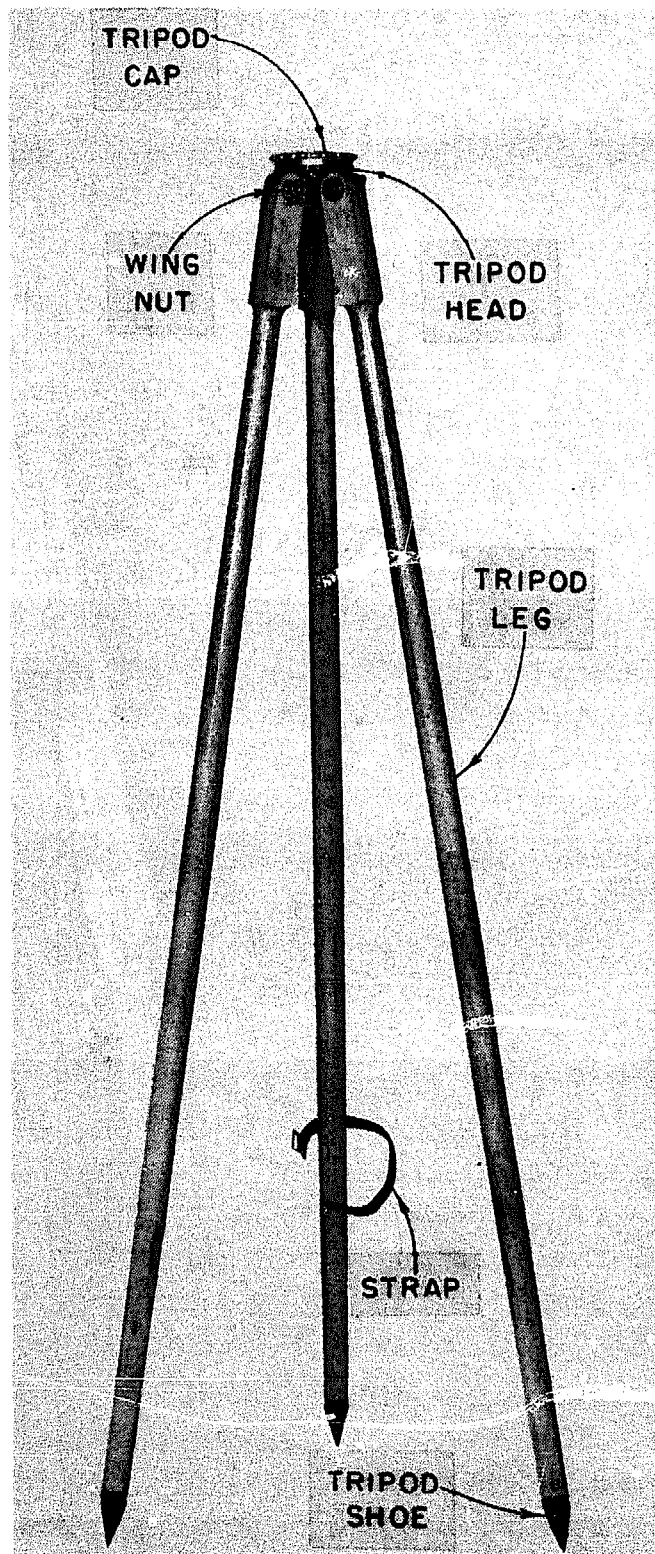

(Photo: The David White Company)

Fig. 3-6. Tripod and cap

woods, or brush, hold the instrument head close to the front of the body. Little damage will be done if the tripod legs strike the side of a door jamb or tree but to allow the level to strike against an object is an "unpardonable sin."

In crossing fences, reach across and set the instrument on the opposite side with the tripod legs well spread out. **Do not allow the instrument to fall.**

4. Setting Up Instruments for Field Use

When setting up the instrument in the field, bring the tripod legs to a firm bearing with the foot plate approximately level. Give the tripod legs additional spread in windy weather or in places where the instrument may be subject to vibration or other disturbances. Most tripod shoes are provided with a projection which the surveyor can step on to force the shoe into the ground. When setting up on a side hill, place two tripod legs at approximately the same elevation downhill and place the other leg uphill, well extended, so that the foot plate will be approximately level.

Level According to Rule

In leveling the instrument, grasp both screws between thumb and forefinger of both hands and turn them in opposite directions so as to loosen one and tighten the other at the same time. Thus the thumbs move either toward or away from each other. The rule to remember is that **the bubble follows the left thumb**. For levels having three screws, level over each of the three—in this case, **the bubble follows the right thumb**. Bring the bubble to the center so that the leveling screws are snug but not too tight against the plate. Turn the telescope over the other pair of leveling screws and center as before. Repeat in both positions for a check.

5. Operating the Instrument

From the very beginning cultivate the habit of delicate manipulation of the instrument. Be sure the eyepiece is perfectly focused on the cross hairs. Follow the instructions of the manufacturer in making this adjustment.

Do Not Force Any Adjustment

Do not tighten clamps too tightly. The ears of clamps and wing nuts are purposely made small so that it is difficult to turn them too tightly.

Never leave an instrument unguarded in the field. Instruments also should never be transported in a vehicle while mounted on the tripod. They should always be placed in the case when returning from the field. In placing the level in the case the lid should close easily and freely. If it does not, the instrument is not placed properly on the pads. Never force the lid; look for the cause of the obstruction.

The tripod cap should always be placed on the tripod head when the tripod is not in use. The threads on the tripod head and those on the instrument foot plate are of brass and can easily be damaged if struck against a hard object.

Engineering equipment should be stored in a dry place. Level rods should be stored in such a manner that they will not warp or become damaged otherwise. Do not leave rods leaning against a wall for long periods of time. They warp from their own weight. If used in damp weather, wipe dry before putting away.

Keep Equipment Serviced

All equipment should be kept clean at all times. A light machine oil may be used to soften grime on leveling screws, foot plate threads, clamp screws, and other

outside parts which may be cleaned without dismantling the instrument. It is better not to leave any oil on the instrument. It does not need lubrication. The oil will catch and hold dust which abrades the soft brass parts.

Measurement of Horizontal Distances

Distances may be measured by pacing or by chaining, depending on the accuracy needed. Engineers also use the stadia method which will not be covered in this book.

Determine Your Pace Factor

Pacing may be used for laying out terraces and diversions and preliminary work on other jobs. Measurement by pacing consists of counting the number of steps between two points and multiplying the number by a predetermined "pace factor." Pace factors will usually vary between individuals. Each person having occasion to use this measurement should determine his individual pace factor.

The pace factor for each individual is the average distance in feet per step. It can best be determined by pacing a measured distance (usually 500 feet) several times. It should be paced enough times so the number of paces for the distance does not vary over 2 or 3 paces. The "pace factor" then would be the distance in feet divided by the number of paces.

Determine your pace factor before you start out to lay out terraces or do other field measuring.

6. Chaining

Chaining is the method of measuring horizontal distances with a steel tape (Fig. 3-7). It is the most common method known and should be used for most measurements in order to get required accuracy.

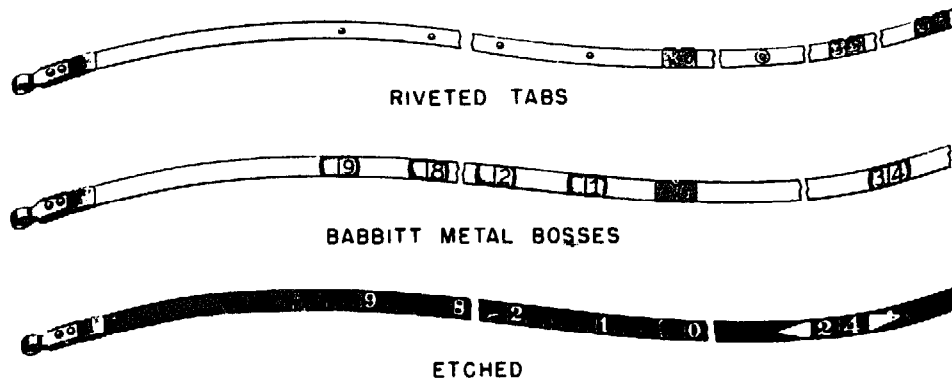

(Photo: The Keuffel and Esser Company)

Fig. 3-7. Steel tape markings.

Survey lines are measured or chained by stations. The distance between full stations is 100 feet. For this reason most steel tapes in use are 100 feet long. When a distance is referred to as so many stations, it means that number of 100-foot lengths. The fractional part of a distance between a full station is called a plus station.

It works like this: The very first stake set at the beginning of a line to be chained is called $0 + 00$. A stake set 25 feet from the first stake would then be called $0 + 25$. A stake set 100 feet from the start is marked $1 + 00$ and so on. See Figure 11-5 (in Chapter XI) which shows this technique used in laying out the fill of a pond. It is a good idea to become familiar with this system of measuring because it is used in all engineering surveys.

7. Laying Out Work with the Dumpy or Wye Level

High school students should not attempt to do more than the simpler type layout jobs with the dumpy and wye level. Keeping field notes, running bench level circuits, changing instrument locations due to change in

elevations and similar maneuvers require much training and experience which high school students probably do not have the opportunity to get. Engineering students in college begin with this type of training.

However, where a contour line is to be laid out, or terraces and diversions staked, or simple profiles made of ditches and other such work is done, particularly where the work can be done with one setting of the level, the level can be used effectively without the necessity of getting into the more complicated survey techniques. It is with this in mind that these instructions are written.

Measuring a Slope in Per Cent

Set the level up on the slope to be measured, selecting a place that is as nearly representative of the slope as possible. Try to avoid places where the slope makes a definite break or where it is steeper or flatter than the predominant condition. If the slope is a long one and there seem to be definite changes in the steepness, it may be necessary to measure it in more than one place.

After setting up the level, have the rodman set up the rod at a point about 50 feet uphill from the level and take a reading. Then have him pace directly downhill 100 feet and then take another reading. The difference in the elevations of these readings is the per cent of slope or fall in feet per 100 feet at that point. (See Fig. 3-8.) By locating the rod so that you read low on it the first time, you will be able to read both shots from the same set-up (under most conditions).

8. Staking Out a Contour Line

In staking a contour line, first set the level up at a point along the location where it is estimated the line

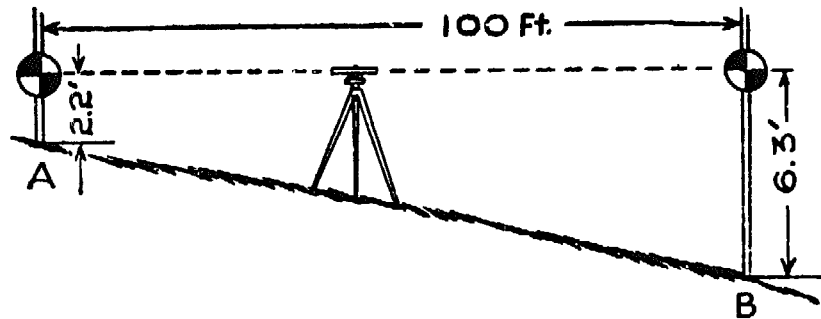

(Drawing: U. S. Soil Conservation Service)

Fig. 3-8. Measuring the per cent of slope with a tripod level. When the distance between readings is 100 feet, the difference in elevation is the per cent of slope.

will be located. This line may be the edge of a contour strip or may be a guide line for planting row crops on the contour. The rodman sets the rod at the first point in the proposed line and the level man takes a sight on the rod, signaling the rodman to move the target up or down on the rod until it is in line with the horizontal cross hair in the telescope. A stake is set at this point and the target is fixed on the rod at that location. From then on the rodman stops at 50- to 100-foot intervals and the level man signals him up or down hill until the level is sighted on the target. This is continued until the line is completed.

Distances should not be too long for each reading. It is recommended that after 400 or 500 feet of line has been staked the level be moved. The rodman must hold the last position until the level is set up and a new reading taken on that spot. The target is then set again on the rod, level with the cross hair. The staking of the line can continue with the target set in the new position (Fig. 3-9). See Chapter VI on contour farming.

9. Staking Terraces

In staking graded terraces the level is set up along the line where the terrace is to be located. The rodman

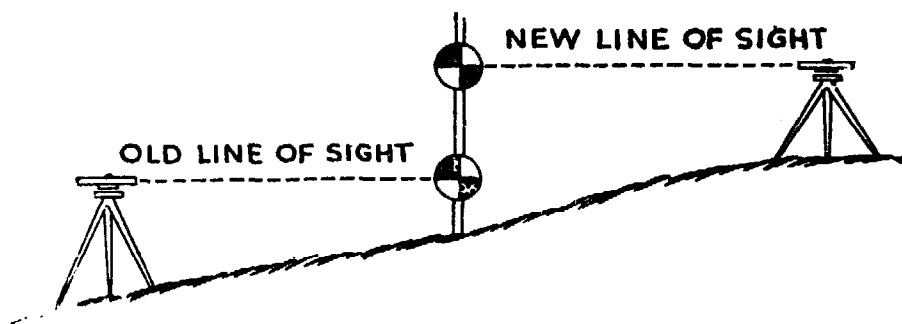

(Drawing: U. S. Soil Conservation Service)

Fig. 3-9. Illustrating the moving of the level and taking a new line of sight on the rod.

sets the rod on the stake marking the end of the terraces. (See Chapter IX for technique of determining terrace spacing.) The target is moved up or down on the rod until it is level with the cross hair in the telescope. The rodman then is responsible for moving the target on the rod before the next stake is set. If the terrace grade is to be 0.4 feet in each 100 feet, he will pace 50 feet and move the target 0.2 feet before taking the next reading. The level man then motions him up or down hill until the target is level with the instrument. Move the target down when working away from the outlet and up when working toward the outlet.

Use of a target places the responsibility on the rodman for the correct grade in the terrace. The rodman also is responsible for pacing accurately between stakes and for setting the rod on average ground for each reading.

If no target is used the level man must read the rod each time it is placed. He then must add or subtract the amount of grade to be put in the terrace before moving the rodman to the proper place.

As a check against errors, each stake setting should be recorded and the rod reading noted. It is easy then to check the grade against the number of stakes. Do not take a chance on forgetting to change the reading

between stakes. As an additional check, run the line again before starting to build the terrace.

10. Running a Profile

It is sometimes necessary to find the exact amount of fall in a given length of a gully in order to determine the treatment it needs or if it is stable and will not under-cut a pond fill. Getting the information on the fall in the ditch is called making a profile.

A simple method is to start at the lower part of the gully to be studied. Set the level so that you read on the upper part of the rod at the first station in order that readings at succeeding stations will be on the rod. This will prevent the necessity of moving the level, at least for a short distance.

You can assume that the first reading is an elevation of 100 feet since you will not be working from a known bench mark. Then as you go up the gully taking readings that rise in elevation, add these differences to 100. For example, assume the first reading is 10.7 feet on the rod. This is arbitrarily called 100 feet. At the next station the reading is 9.5 on the rod, a difference of 1.2 feet. The elevation at the second station is then 101.2 feet. If the rod reading at the third station is 8.6 feet, a rise of another 0.9 foot, the elevation at the third station is 102.1 feet. This method is continued to the end of the gully or the end of the part to be studied.

These figures can be plotted on graph paper so that you can picture clearly the profile of the gully.

Simple studies like this can be made without too much note taking, particularly where only one setting of the level is used. For more complicated jobs more elaborate notes will be needed. Refer to U.S.D.A. Handbook No. 135 for more information on this subject.

Sometimes you will need to run profiles of cross sections of the area above a proposed pond fill to deter-

mine how much earth is to be moved and from which places. These cross sections will be needed at intervals of 50 feet or some appropriate spacing, parallel to the centerline of the fill. (See Chapter XI on ponds.)

As suggested in the procedure for taking a gully profile, assign an assumed elevation to the first station and then add to or subtract from it at the successive readings.

As explained in the chapter on ponds, these cross sections can be plotted on graph paper to picture more clearly the amount of earth to be moved and where it will be removed and needed to make the best pond.

Chapter

IV

CALCULATING THE RUNOFF FROM A WATERSHED

The design, construction and management of many conservation practices depend to a large extent on the amount of rain water that must be carried from the field as contrasted to that which will be absorbed. It is this runoff that creates the erosion problem. The width of waterways, the design of pond fills and spillways and of other structures depend on the amount and speed of this runoff water. It is for this reason that this section on calculating the amount of runoff from a given watershed is included in this book. Reference to this chapter will need to be made in the design of waterways, structures and ponds.

A Suggested List of Activities Involving Approved Practices

1. Determining Rainfall Frequency
2. Calculating Runoff
3. Determining Watershed Runoff

The amount of runoff from a given drainage area depends on many interrelated factors for its deter-

mination. Watershed characteristics, such as slope, shape, size, cover, or soil, and the storm characteristics, such as amount, intensity, duration, or occurrence of rainfall, have a direct effect on the peak flow and volume of runoff from any area.

Other things being equal, a drainage area of steep slope, poor vegetal cover, and impervious soil will contribute a greater amount of runoff than one of moderate slope, good cover, and pervious soil. Some soils have more capacity to store water than others. Therefore these factors: slope, ability of the soil to absorb water, the vegetal cover, and the amount of water stored on the surface, plus the rate and amount of rainfall, make up the factual information necessary to calculate the runoff.

1. Determining Rainfall Frequency

In designing a conservation practice or structure the **probable** amount and rate of rainfall must be used. The probability of a big rain conducive to high runoff is much greater in a 50-year period than it is in a 25- or a 10-year period. Rainfall frequencies are based on weather records over the past as long as the records have been kept. They are spoken of as 10-year storms or 25-year storms, and so on. A 10-year storm is a storm which, based on past weather records, can be expected to occur every 10 years; a 50-year storm every 50 years, and so on. The runoff rate for a 50-year design is greater than for 25-year, and 25-year in turn is greater than for 10-year.

Use 10-Year Frequency for Grass Waterways

It is recommended that 10-year frequency be used for designing grassed waterways and small diversions where vegetated outlets are provided. For designing farm structures impounding water or spillways con-

structed of permanent materials, 50-year frequency is recommended. (These may vary in different localities and should be checked with local technicians experienced in soil conservation design.)

2. Calculating Runoff

The runoff rate is measured in cubic feet per second (cfs). This term will be used in determining the capacity of waterways and structures.

The method described here is a simple way of obtaining a reasonable estimate of surface runoff. There are many other methods used. This one has been used successfully by technicians of the Soil Conservation Service in the Corn Belt states and is now being used in other parts of the country. Some local variations may be necessary in using it nationally. Even this simple procedure requires experience and judgment.

In order to arrive at a satisfactory figure for the cubic feet per second of water that will flow past a given point, Table 4-1 has been prepared showing the runoff producing characteristics of watersheds. This table combines and describes the normal runoff producing characteristics of a drainage area, such as moderate ground slopes within the range of 5 to 10 per cent, normal soil infiltration, fair vegetal cover, and normal surface storage.

Values are given to these different factors (the numbers in parentheses that appear in the chart). The values added together make up what we shall call the summation of watershed characteristics, indicated by the symbol ΣW .

The map of the United States (Fig. 4-1) shows the distribution of rainfall factors for different parts of the country. The curves are based on a rainfall factor of 1. Used in combination with Table 4-1 you can calculate the expected rate of runoff in any given area.

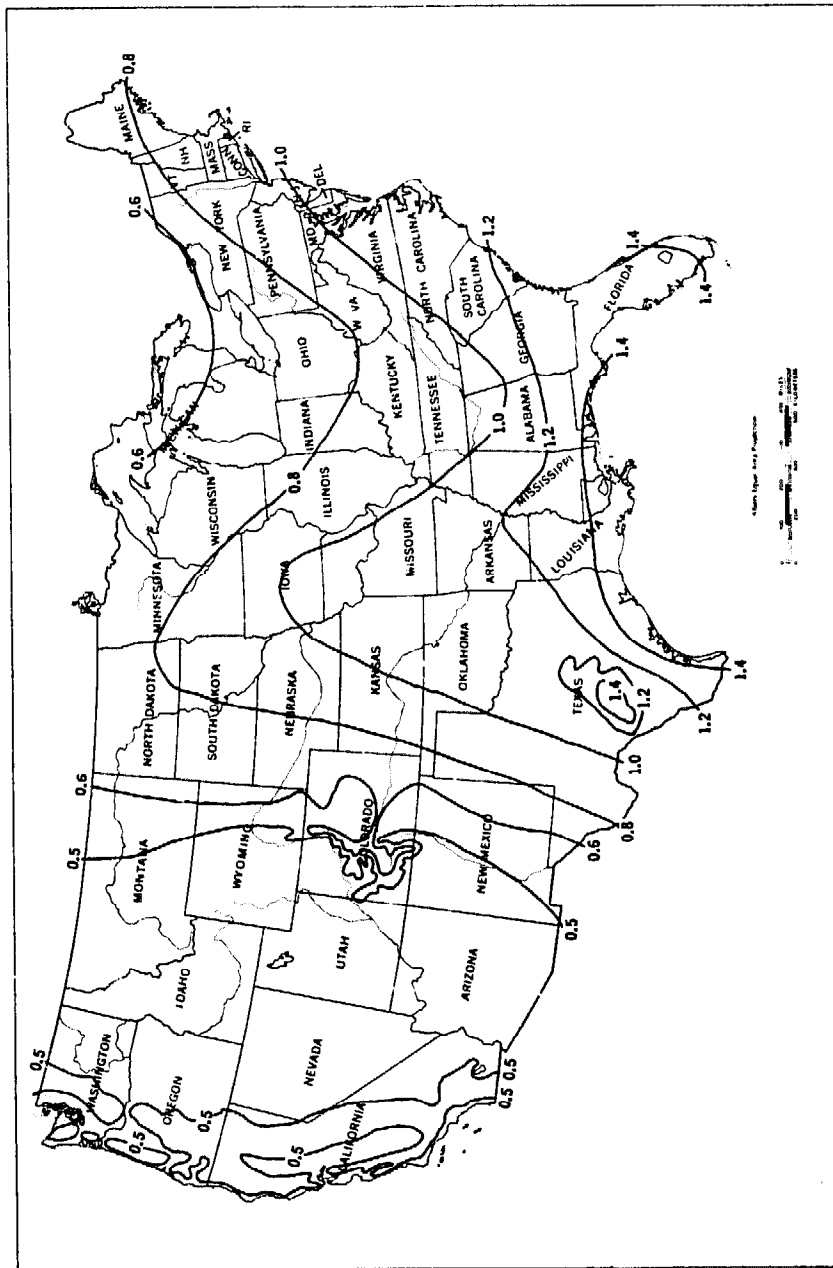

(From Farmers' Bulletin 1859, U.S.D.A.)
 Fig. 4-1. Rainfall factors to be used in determining runoff from watersheds in different parts of the country.

Use Runoff Tables

In order to calculate the runoff needed in the design of a structure of permanent materials or for a grassed waterway, runoff tables are needed (Table 4-2 and Table 4-3).

An example for figuring runoff needed in the design

of a structure of permanent materials would be as follows: Assume that there are 93 acres in the drainage area of which 60 acres are cropland (strip cropped) and 33 acres are pasture. The slope averages 6 per cent and the soil is average loam. The waterways are well defined (no places where water stands such as marshes and ponds).

Then from Table 4-1, the summation of watershed characteristics equals:

Relief for average slope of 6%.....	12
Soil infiltration for average loam.....	10
Vegetal cover—10 for strip-cropped area 5 for pasture area	
Interpolating $\frac{(10 \times 60) + (5 \times 33)}{93}$	8
Surface storage for a well defined drainage system	15
Summation of watershed characteristics (ΣW)	45

(Careful judgment is needed in arriving at the values in the right hand column taken from Table 4-1. The value "12" is given for "Relief for average slope of 6%." This first requires the ability to measure slopes. Such information may be taken from a soil survey already prepared. To arrive at the average slope for the area requires experience and judgment. Table 4-1 gives a value of 10 for slopes of 0 to 5% and 20 for slopes averaging 5 to 10%. In this example the average slope is 6%. Judgment along with interpolating, in this case, makes the value of 12 seem reasonable. Similarly, experience and judgment are needed for arriving at the other values.)

Then from Table 4-3 for 50-year frequency, find the runoff by locating 90 (nearest to 93 acres) in the first

TABLE 4-1. Runoff producing characteristics of a watershed.

Designation of Watershed Characteristics	Runoff Producing Characteristics			
	100 Extreme (40)	75 High (30)	50 Normal (20)	25 Low (10)
Relief	Steep, rugged terrain, with average slopes generally above 30%.	Hilly, with average slopes of 10 to 30%.	Rolling, with average slopes of 5 to 10%.	Relatively flat land, with average slopes of 0 to 5%
Soil infiltration	No effective soil cover, either rock or thin soil mantle of negligible infiltration capacity.	Slow to take up water, clay or other soil of low infiltration capacity, such as heavy gumbo.	Normal; deep loam with infiltration about equal to that of typical prairie soil.	High; deep sand or other soil that takes up water readily and rapidly.
Vegetal cover	No effective plant cover, bare or very sparse cover.	Poor to fair; clean-cultivated crops or poor natural cover; less than 10% of drainage area under good cover.	Fair to good; about 50% of drainage area in good grassland, woodland, or equivalent cover; not more than 50% of area in clean-cultivated crops.	Good to excellent; about 90% of drainage area in good grassland, woodland, or equivalent cover.
Surface storage	Negligible; surface depressions few and shallow; drainage-ways steep and small; no ponds or marshes.	Low; well-defined system of small drainage-ways; no ponds or marshes.	Normal; considerable surface-depression storage; drainage system similar to that of typical prairie lands; lakes, ponds and marshes less than 2% of drainage area.	High; surface-depression storage high; drainage system not sharply defined; large flood-plain storage or a large number of lakes, ponds or marshes.

(From U.S.D.A. Handbook No. 135)

TABLE 4-2. Runoff chart for design of grass waterways based on 10 years frequency and rainfall factor of 1.0.

DRAINAGE AREA IN ACRES	WATERSHED CHARACTERISTICS										
	30	35	40	45	50	55	60	65	70	75	85
	P ₁₀ ²			CUBIC	FEET	PER	SECOND				
4	5	7	8	9	10	11	13	15	17	20	24
6	6	8	10	11	13	16	18	21	24	28	34
8	7	9	12	13	17	20	24	28	32	37	44
10	8	10	14	16	21	25	30	35	40	46	53
12	9	11	16	19	24	29	35	41	48	54	62
14	10	13	18	22	28	33	40	47	55	62	71
16	11	15	20	25	31	38	45	53	62	70	80
18	12	17	22	28	34	42	50	59	79	78	89
20	14	19	24	31	38	46	55	65	76	86	98
25	16	22	28	36	46	55	66	78	90	103	118
30	18	25	32	42	53	64	77	91	105	120	139
35	20	28	36	47	60	73	87	104	120	137	159
40	22	32	41	53	68	82	98	117	135	154	179
45	24	36	46	59	76	91	109	130	150	171	200
50	26	40	51	65	83	100	119	142	165	188	220
60	30	45	59	76	97	117	139	165	193	221	259
70	34	50	66	87	110	133	159	188	221	253	298
80	38	55	74	97	123	149	179	211	248	285	338
90	42	60	81	107	136	166	199	234	274	317	378
100	46	65	88	117	150	182	218	256	300	348	418
120	53	75	102	135	175	213	258	300	351	410	487
140	60	85	116	154	200	244	293	344	401	471	556
160	67	95	129	172	224	275	329	388	451	529	625
180	73	105	142	190	248	305	364	432	500	585	694
200	79	115	155	207	271	334	398	476	550	640	764
220	85	124	168	224	294	363	432	516	598	693	832
240	91	132	180	241	317	392	464	556	645	746	899
260	97	141	192	257	340	421	496	595	691	799	964
280	102	149	204	273	362	450	528	634	736	852	1028
300	108	158	216	289	384	480	560	672	781	905	1090
320	114	167	228	305	407	505	591	709	824	956	1150
340	119	175	240	321	429	530	623	746	867	1007	1210
360	124	184	253	337	451	555	654	783	909	1058	1270
380	129	192	265	355	473	580	684	820	952	1109	1330
400	135	200	277	371	494	605	713	856	994	1160	1390
420	141	208	288	386	515	629	741	891	1035	1209	
440	146	216	299	401	535	653	769	926	1076	1257	
460	151	224	310	416	554	677	797	961	1117	1303	
480	156	232	321	432	572	700	825	996	1158	1348	
500	161	239	332	447	590	723	853	1030	1199	1392	
520	166	246	342	462	607	746	881	1064	1238	1435	
540	171	253	352	476	624	769	909	1098	1277	1478	
560	176	260	362	490	641	791	937	1131	1315	1521	
580	181	267	372	504	658	813	965	1164	1350	1563	
600	185	274	382	518	675	835	993	1197	1386	1605	

(From U.S.D.A. Handbook No. 135)

TABLE 4-3. Runoff chart for design of permanent structures based on 50 years' frequency and rainfall factor of 1.0.

DRAINAGE AREA IN ACRES	WATERSHED CHARACTERISTICS												
	25	30	35	40	45	50	55	60	65	70	75	80	100
					P ₅₀	CUBIC	FEET	PER	SECOND				
4	5	7	10	11	13	14	15	18	21	24	28	34	36
6	6	8	11	14	15	18	23	25	30	34	40	48	51
8	7	10	13	17	18	24	28	34	40	45	52	62	66
10	8	11	15	19	24	29	35	43	50	58	66	75	81
12	9	12	17	22	28	34	41	50	59	68	78	88	97
14	10	14	19	25	32	39	47	57	68	78	90	101	112
16	11	15	21	28	36	44	53	64	76	87	100	114	127
18	12	17	24	31	40	49	59	71	84	96	110	126	142
20	13	19	26	33	43	53	64	77	92	105	120	138	155
25	16	22	31	40	52	64	78	93	110	128	146	168	190
30	18	25	36	47	60	75	91	109	128	149	172	198	225
35	20	28	41	53	68	86	104	124	146	170	196	228	260
40	22	31	45	59	76	97	117	139	164	190	221	257	295
45	24	34	49	65	84	107	130	154	182	210	245	286	330
50	26	37	53	71	92	117	142	168	200	230	267	315	365
60	29	43	62	82	108	136	165	197	234	270	314	366	435
70	32	49	70	93	123	155	188	226	268	310	360	425	505
80	36	54	78	104	137	173	211	255	301	350	406	478	570
90	40	59	85	114	151	193	233	281	334	389	448	530	635
100	43	64	92	124	165	210	255	307	365	426	490	590	700
120	49	74	107	144	192	246	300	359	427	500	574	690	825
140	55	84	121	164	218	281	345	410	487	570	658	790	950
160	61	94	134	183	243	315	390	460	547	640	740	890	1070
180	67	103	147	202	268	349	430	510	607	710	820	990	1190
200	73	111	160	220	292	383	470	560	667	780	900	1080	1310
220	78	119	173	237	316	416	510	610	724	845	980	1170	1420
240	83	127	186	254	340	449	550	660	781	910	1060	1260	1530
260	88	135	199	271	363	481	590	704	838	970	1134	1350	1640
280	93	143	211	288	386	513	630	748	894	1030	1207	1440	1750
300	98	151	223	305	409	545	670	792	950	1090	1280	1530	1860
320	103	159	235	322	432	576	705	836	1000	1150	1350	1620	1970
340	108	167	247	339	455	604	740	880	1050	1210	1420	1710	2080
360	113	174	259	356	478	633	775	924	1100	1270	1490	1800	2190
380	118	182	270	373	501	662	810	967	1150	1330	1560	1890	2290
400	123	190	281	390	523	691	845	1010	1200	1390	1630	1980	2390
420	128	197	292	405	544	720	880	1048	1248	1448	1694	2064	2490
440	133	204	303	420	565	748	915	1086	1296	1506	1758	2148	2590
460	137	211	314	435	586	776	950	1124	1344	1564	1822	2232	2690
480	141	218	325	450	607	803	985	1162	1392	1622	1886	2316	2790
500	145	225	335	465	628	830	1020	1200	1440	1680	1950	2400	2885
520	149	232	345	480	648	856	1050	1238	1486	1734	2010	2476	2980
540	153	239	355	495	668	882	1080	1276	1532	1788	2070	2552	3075
560	157	245	365	510	688	908	1120	1314	1578	1842	2130	2628	3170
580	161	250	375	525	708	934	1140	1352	1624	1896	2190	2704	3265
600	165	255	385	540	728	960	1170	1390	1670	1950	2250	2780	3360

(From U.S.D.A. Handbook No. 185)

column, then move to the right to the column under the number "45" which gives you 151 cubic feet per second. Referring to the map (Fig. 4-1), if the structure were being constructed in southern Michigan, then from the map:

$$\begin{aligned}\text{Rainfall factor "R"} &= 0.7 \\ Q &= (151) (0.7) \\ &= 106 \text{ cu. ft. per sec.}\end{aligned}$$

Since a storm frequency of 50 years was used this is the final figure needed for design of the structure.

If a grassed waterway is being designed, then a 10-year frequency factor is used which has been considered in preparing Table 4-2. Using this table in the same way as in the previous example, enter the chart at 90 acres and moving to the right under the column headed 45, you come to 107 cubic feet per second. This is the runoff rate you would expect to handle in an area with a rainfall factor of 1.0. Again, if you were designing the waterway in southern Michigan (see map, Fig. 4-1) use the rainfall factor 0.7 and you will get 75 cfs. This is the runoff rate you would use in designing the grassed waterway.

For design of grassed waterways, see Chapter V.

3. Determining Watershed Runoff

Figure 4-2 shows a 120-acre farm on which small watersheds are outlined. Additional examples are given here to help in understanding the method of calculating runoff rates from watersheds with different characteristics and of different sizes.

Let us assume that a waterway is to be constructed and seeded between points a and c. The area to be served by the waterway is shown by the shaded area on the map. The number of acres in the watershed may be determined from an aerial photograph and by field

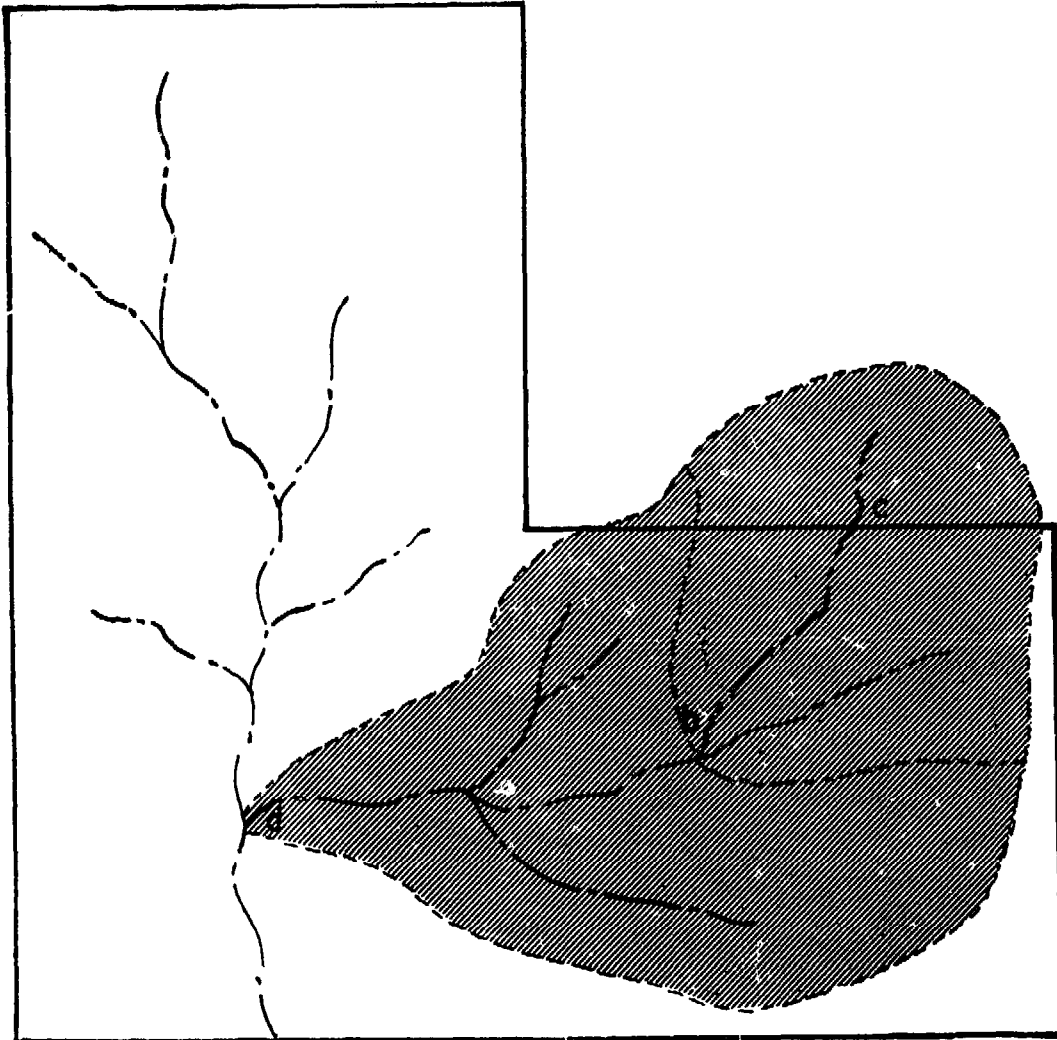

(Drawing: U. S. Soil Conservation Service)

Fig. 4-2. A 120-acre farm drawn to a scale of 8 inches to a mile. The shaded area covers one small watershed.

checking to locate the divides and marking them on the photograph. This can be done where the topography is clearly defined. Otherwise topographic surveys should be made by trained technicians. The area outlined can then be measured by the use of a planimeter or by a transparent overlay marked off in squares according to the scale of the map. The farm in Figure 4-2 is drawn to a scale of 8 inches to the mile. At this scale, one square inch is equal to 10 acres, four square inches, 40

acres, and so on. By breaking these units down so that one square inch is divided into ten parts, then each of these parts equals one acre. This is accurate enough for this purpose.

The entire watershed covers 49 acres on this farm, according to the scale described, and there are 7 acres in the watershed that lie across the farm boundary on the neighbor's land, making a total of 56 acres. The land on the neighbor's farm must be used in the calculations since runoff water from it will flow down the waterway. All the land in the watershed that is on this farm, 49 acres, is strip cropped and is rolling with slopes from 5 to 10 per cent. The soil is rather slow to take up water, being a clay or silty clay loam with fairly tight subsoil. The 7 acres on the neighbor's farm is similar except it is in clean cultivated crops with no soil conservation practices.

From Table 4-1, the summation of watershed characteristics equals:

Relief for average slope 5 to 10%.....	20
Soil infiltration for tight soil.....	15
Vegetal cover 10 for strip-cropped area 15 for neighbor's land	
Interpolating $(10 \times 49) + (15 \times 7)$	11
<u>56</u>	
Surface storage well defined drainage system, no ponds or marshes.....	15
Summation of watershed characteristics (ΣW)	<u>61</u>

Then from Table 4-2 find the runoff rate by locating 60 (the figure nearest to 56 acres) in the left-hand column and moving across to the column under 60 which is nearest to 61 (watershed characteristics) which gives 139 cfs. Since the actual area is 56 acres, a figure about half-way between 139 and 119, the next

figure in the column, should be used, or about 129 cfs. This is the rate of runoff that would be expected at point "a" in an area with a rainfall factor of 1. At point "b" the rate would be determined by the area and nature of the watershed above "b" and the waterway would be narrower here since the values are smaller.

If a structure is to be built at point "a" then use Table 4-3. About 182 cfs would be the runoff rate for which the structure would be designed in an area with a rainfall factor of 1.

The watershed above "b" contains 19 acres, 7 of which are on the neighbor's land. Summarize the watershed characteristics and calculate the runoff rate at "b" for 10-year and for 50-year frequencies using the same watershed characteristics as given for this farm and for the neighbor's farm shown in Fig. 4-2. Using the map in Figure 4-1, calculate these runoff rates for the area in which you live.

Chapter

V

GRASSED WATERWAYS AND OUTLETS

The grassed waterway is one of the most common and basic conservation practices generally recognized, accepted, and used by farmers (Fig. 5-1). Wherever



(Photo: U. S. Soil Conservation Service)

Fig. 5-1. Forty-foot-wide alfalfa-bromegrass sod waterway in Michigan.

there is rainfall, there are conditions under which a surplus of water will pass over the land in the form of runoff. With crop rotations, contour farming, strip cropping, or even terraces, there will be runoff during heavy rains and when the soil is saturated.

This water will collect in the natural draws and flow from the field. Safe removal of this surplus water is a problem common to every farm. The success of any soil conservation program depends on the removal of this surplus water without damage to the land.

A Suggested List of Activities Involving Approved Practices

1. Locating the Waterway
2. Designing the Waterway
3. Determining Water Velocity
4. Calculating Waterway Dimensions
5. Shaping the Waterway
6. Constructing the Waterway
7. Providing Drainage
8. Seeding the Waterway
9. Protecting Waterways

1. Locating the Waterway

In general, the most satisfactory location is a natural drainageway. If the waterway is used in connection with strip cropping or contour farming (without terraces) the natural drainageway will, of course, be the only choice. But even with the use of terraces, where water can be carried across draws, it is usually best to select the natural drainageway for the terrace outlet.

Water flows toward the draw naturally. The natural slope of the land confines the flow of water, thus making unnecessary the construction of berms along the sides. Natural draws usually contain the best soil unless gullied, and there is more moisture so that conditions

the dimensions of the channel so that the estimated flow will be discharged without damage to the lining. The lining here considered is vegetation which can vary as to type and density. The speed (velocity) at which water can flow safely over each condition has been determined by test and experience. The range of permissible velocities will be determined by each individual area. But the following suggested general rules for determining velocities are given by U.S.D.A. Handbook No. 135:

1. A velocity of three feet per second will apply to a poor type sod where, because of climate or soil, only a sparse cover can be expected.
2. A velocity of four feet per second should be used under normal conditions where the waterway is to be established by seeding.
3. A velocity of five feet per second should be used only in areas where vigorous sod is quickly obtained or where water can be diverted out of the waterway while seeding is being established.
4. Velocities of six feet per second may be used only when a vigorous growth of dense, permanent sod is already established, or where water can be diverted out of the waterway while sod of this type is being established.
5. Velocities of seven feet per second can be used only on established sod of excellent quality, and only under special circumstances which cannot be handled at a lower velocity. This condition will require special maintenance. Under average conditions the maximum design velocity should be four feet per second.

4. Calculating Waterway Dimensions

In making the calculations the following data are needed:

- a. The area of the watershed. Don't forget to

include that of a neighbor if water from his land must flow into the waterway.

- b. The soil characteristics, crops, and topography, using the 10-year frequency chart (Table 4-2).
- c. The slope (grade) of the waterway in per cent. (This is the vertical fall per 100 feet of length.)
- d. Estimate of permissible velocity as listed above.
- e. The table of waterway dimensions (Table 5-1) has been prepared from basic hydraulic data to eliminate time-consuming steps in calculations.

The table can be used for the design of either the parabolic (saucer) or trapezoidal cross sections.

Example of waterway design calculation:

Given:

1. Watershed area—20 acres.
Watershed characteristics $\Sigma W = 50$ (from Table 4-1, Chapter IV.)
2. Slope of waterway—5%.
3. Permissible velocity—(to be seeded). Select three feet per second.
4. Rainfall factor $R = 0.8$ (determined by location from map, Fig. 4-1, Chapter IV).

Solution:

From runoff chart, Table 4-2, Chapter IV.

20 acres with watershed characteristics of 50 gives 38 cfs.

38×0.8 (rainfall factor) equals 30.4. Use 30 cfs for design.

Enter grass waterway dimension chart, (Table 5-1), on line reading 30 cfs in the left-hand column. Follow to the right and under the column headed 5% slope, reading under velocity of three feet per second, find the reading of "45," which is the width in feet.

In the same column at top under the three feet per second velocity read the depth of 0.4 foot. This results in a top width at the water surface of 45 feet and a

TABLE 5-1. Grass waterway dimension chart.

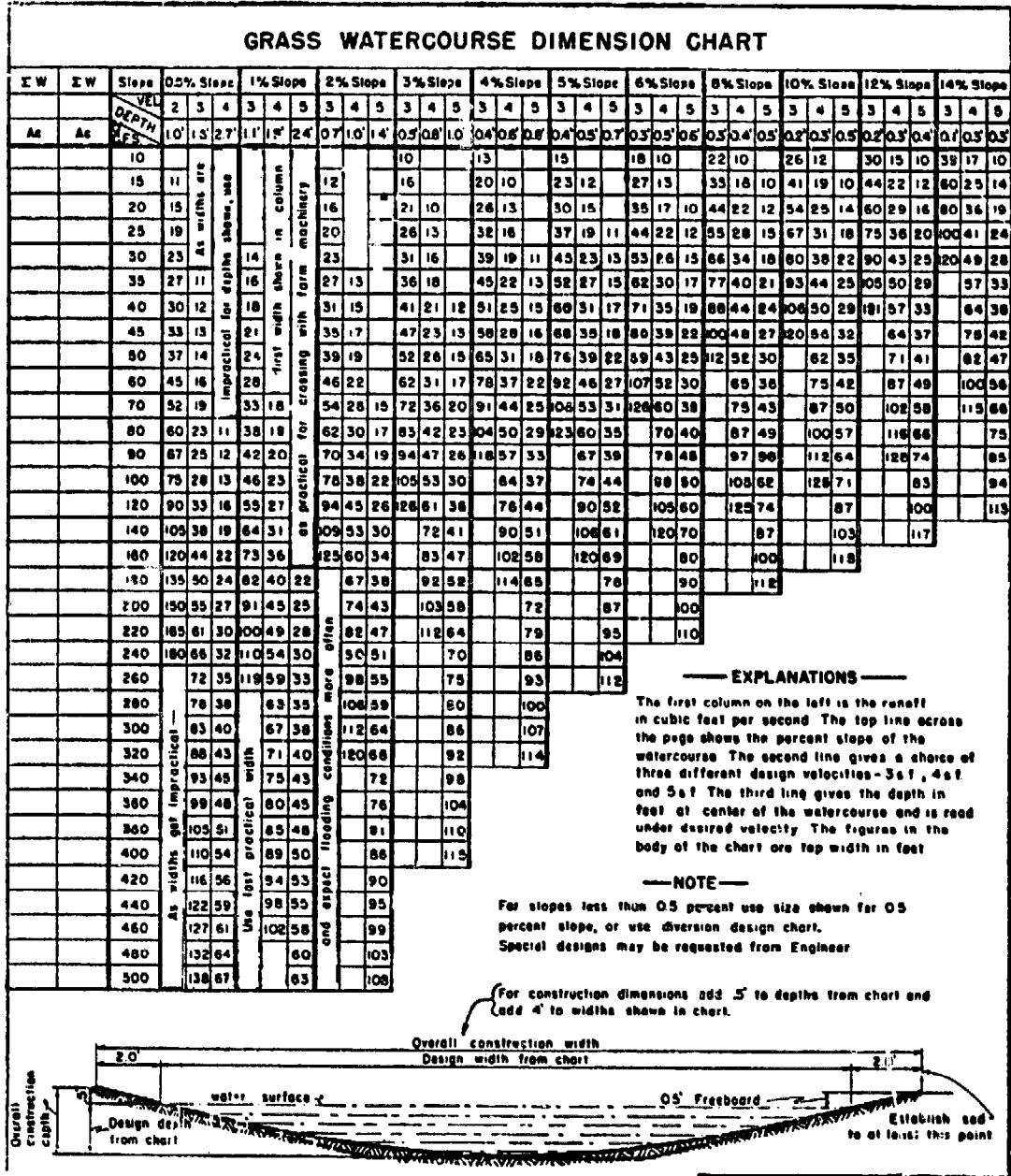

(From U.S.D.A. Handbook No. 135)

flow depth of 0.4 foot to handle the discharge of 30 cfs at a velocity of three feet per second.

If the waterway is to be constructed in a natural draw, no freeboard is necessary. But if it is constructed along a field boundary or other site it will require freeboard; add four feet to the width and 0.5 foot to the depth. Under these conditions it is well to consider the possibility of diverting as much of the flow of water as possible by use of diversions until the construction and vegetation are accomplished. Also, extra care in maintenance will be required.

If, after considering site conditions, the above waterway is too wide, the alternative is to use a higher velocity for design, resulting in a narrower width. In this example, using a velocity of 4 feet per second instead of three, and allowing for freeboard, the constructed and vegetated width would be 23 plus 4, or 27 feet, with over-all depth of 0.5 plus 0.5, or 1.0 foot.

5. Shaping the Waterway

Vegetated waterways are of several shapes or cross sections—trapezoidal (flat bottom), parabolic (saucer or dish-shaped bottom), or “V” shaped. In general, the

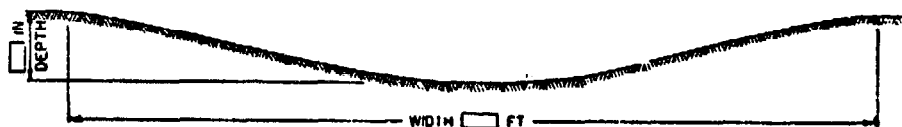

(Drawing: U. S. Soil Conservation Service)

Fig. 5-2. The parabolic, or saucer shaped waterway is best suited to general purposes.

saucer shaped waterway is the most common. (Fig. 5-2.) Most of those constructed with the trapezoidal section end up as parabolic after a few years. The “V” type is used in special situations.

The trapezoidal cross section is not a natural shape and is limited in its application. Since the bottom is flat there is a tendency for the water to meander when the flow is light which may cause erosion along the sides or cutting through the sod. It is also difficult to construct.

The parabolic, or saucer shaped, waterway is best suited for general purposes because it is easily shaped, small flows are better confined to prevent meandering and it is the most common shape found under natural conditions. It lends itself to construction most easily with regular equipment.

6. Constructing the Waterway

Construction of the waterway may be done with different kinds of equipment and the procedure varies according to the condition of the site. Many excellent waterways have been prepared by using only a plow, disk and harrow. These tools work best when it is possible to drive the tractor anywhere over the waterway area without danger of overturning the tractor.

Where Center Is Gullied

If the waterway is to be constructed where a gully already exists (Fig. 5-3) the procedure will naturally need to be adjusted for this condition. After the trash and debris have been removed from the waterway area the waterway should be staked out. The boundaries then may be marked either with stakes or with a plow.

If the gully is not too large it may not be necessary to use a grader or bulldozer, although these tools will probably speed up the job. If a plow only is to be used begin plowing along the edge of the gully throwing the furrows toward the center, using care not to upset the tractor. Continue plowing until the ditch is sufficiently filled to permit crossing. The desired cross

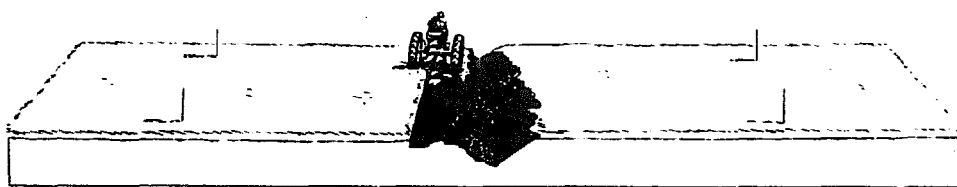

Start by plowing around the gully, throwing the furrows toward the center. This requires care and skill to avoid upsetting the tractor.

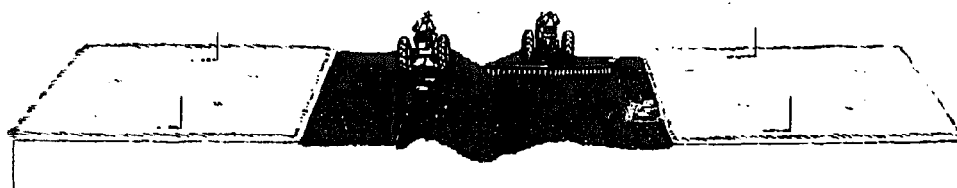

Continue replowing until the area can be crossed easily with farm machinery. A disk can be used to help move the dirt and to smooth it up for seeding. The filled area should be packed by running over it with the tractor wheels. Blend the edges of the plowed area so they fit smoothly into the field.



The area is now ready for seedbed preparation.

(Drawing: U. S. Soil Conservation Service)

Fig. 5-3. Constructing a waterway when center is gullied.

section is then obtained by backfurfrowing at the low point and plowing lands as required.

If the gully is too deep for the use of the plow or if part of the drainageway is gullied, the bulldozer should be used. (Fig. 5-4.) Do not allow more than 8 to 12 inches of loose material to accumulate without compacting. Then sloping can be resumed and the process repeated until completed.

A manure loader may be used to advantage to slope steep banks by pushing in dirt from the top.



Start the cut at the stake or furrow line and move the dirt toward the center, thus filling the existing ditch or gully.

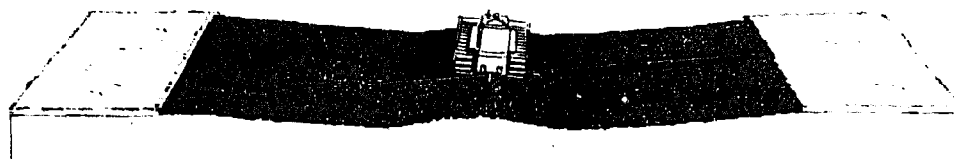

Pack the fill and smooth out the edges until the waterway becomes dish shaped. The waterway is then ready for seedbed preparation.

(Drawing: U. S. Soil Conservation Service)

Fig. 5-4. Constructing a waterway with a bulldozer

Small graders with a blade length not to exceed six feet can be used to supplement the plow in working in and completing the grading. The highway auto patrol grader is excellent equipment for all kinds of waterway work.

In extreme cases of poor and infertile soil areas, it may be desirable first to remove the remaining topsoil and work it away from the waterway area, then grade in the waterway, and later bring back the topsoil as a covering for the waterway. This is difficult and expensive but may be necessary in order to establish and maintain healthy vegetation.

Where Center Is High

When it is necessary to construct an outlet or waterway along a fencerow, ridge line, or across a level portion of a bottom field, it is usually necessary to move earth out of the proposed waterway (Fig. 5-5). After staking and removing trash and debris, start plowing from the outside, throwing the furrows to the



Start the cut at the stake or furrow line and move the dirt toward the center, thus filling the existing ditch or gully.

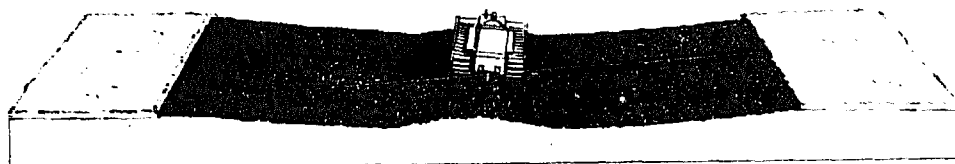

Pack the fill and smooth out the edges until the waterway becomes dish shaped. The waterway is then ready for seedbed preparation.

(Drawing: U. S. Soil Conservation Service)

Fig. 5-4. Constructing a waterway with a bulldozer

Small graders with a blade length not to exceed six feet can be used to supplement the plow in working in and completing the grading. The highway auto patrol grader is excellent equipment for all kinds of waterway work.

In extreme cases of poor and infertile soil areas, it may be desirable first to remove the remaining topsoil and work it away from the waterway area, then grade in the waterway, and later bring back the topsoil as a covering for the waterway. This is difficult and expensive but may be necessary in order to establish and maintain healthy vegetation.

Where Center Is High

When it is necessary to construct an outlet or waterway along a fencerow, ridge line, or across a level portion of a bottom field, it is usually necessary to move earth out of the proposed waterway (Fig. 5-5). After staking and removing trash and debris, start plowing from the outside, throwing the furrows to the



Start the cut at the stake or furrow line and move the dirt toward the center, thus filling the existing ditch or gully.

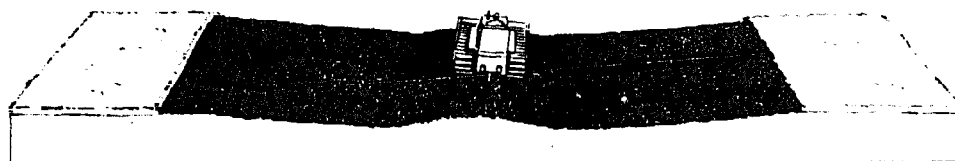

Pack the fill and smooth out the edges until the waterway becomes dish shaped. The waterway is then ready for seedbed preparation.

(Drawing: U. S. Soil Conservation Service)

Fig. 5-4. Constructing a waterway with a bulldozer

Small graders with a blade length not to exceed six feet can be used to supplement the plow in working in and completing the grading. The highway auto patrol grader is excellent equipment for all kinds of waterway work.

In extreme cases of poor and infertile soil areas, it may be desirable first to remove the remaining topsoil and work it away from the waterway area, then grade in the waterway, and later bring back the topsoil as a covering for the waterway. This is difficult and expensive but may be necessary in order to establish and maintain healthy vegetation.

Where Center Is High

When it is necessary to construct an outlet or waterway along a fencerow, ridge line, or across a level portion of a bottom field, it is usually necessary to move earth out of the proposed waterway (Fig. 5-5). After staking and removing trash and debris, start plowing from the outside, throwing the furrows to the

outside. This will result in a dead furrow being left at the center. Continue plowing until the desired cross section is accomplished. Several plowings may be needed.

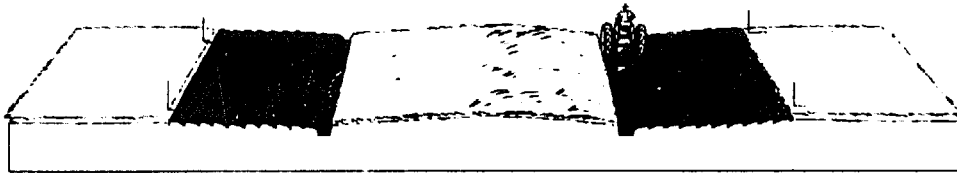

Plow around the area beginning at the outside edge and throwing the furrows away from the center. A dead furrow will be left in the center.



Plow and replot, moving the dirt outward from the center until the desired cross section is obtained. This will require several replowings. The waterway is then ready for seedbed preparation.

(Drawing: U. S. Soil Conservation Service)

Fig. 5-5. Constructing a waterway when center is high.

7. Providing Drainage

Tile drainage of waterways is essential where the land tends to stay wet and in areas where tile is generally used. Tile drainage may also be needed in some well-drained soils where seepage occurs in the waterway.

The waterway must be well drained so that it will not be damaged by crossing with machinery or by livestock. Tile should be laid immediately following grading of the waterway. Tile lines should be laid to one side of the waterway and deep enough so that any laterals will have a minimum cover of 2.5 feet at the low point in the waterway. Tile lines should outlet at a

permanent structure or by use of corrugated pipe. (See Chapter XIX on drainage.)

8. Seeding the Waterway

One of the first decisions to be made in seeding a waterway is the kind of grass to be used. In selecting the grass it is necessary to know how deep and how dense the root system will be. A grass should be chosen that grows thick on the ground and will bend under running water and rise back up when the runoff stops. The grass must be suited to the soil and climate.

According to U.S.D.A. Leaflet 257, "Grass Waterways," Kentucky bluegrass is an ideal grass for channels in soils that are high in organic matter. It has a dense root system that grows close to the surface and the top growth is moderately short and thick.

Chewings fescue is similar to bluegrass and, in addition, will grow on soils low in organic matter, such as sands. Timothy is well adapted to a wide range of soil conditions. But it is a bunchgrass and must be used with other grasses such as red top to form a thick sod. Bromegrass has a root system that is deeper than bluegrass but not so dense. It is particularly well suited to deep, fertile soil.

Tall fescues are excellent wet-land grasses that stand up under a heavy flow of water. Reed canarygrass will also grow in wet soils but should be used only where there is a deep, well-defined waterway. It is not suited to shallow waterways. Its tall, dense growth causes silting which makes a dam across the waterway. These dams may force the water out of the designed channel or make it meander back and forth in the channel.

Prepare Firm Seedbed

A good seedbed is the key to getting a good stand of grass in the waterway. If the entire field is being

seeded to meadow, the seedbed for the waterway can be prepared at the same time, using the same tools. In terrace outlets and other specially built channels, however, some extra work will probably be needed.

Use Manure

If available, barnyard manure should be put on at the rate of 10 to 20 spreader loads per acre, and worked into the soil thoroughly (Fig. 5-6). This may be done by disking alone but usually better results can be had by plowing the channel after the manure has been worked into the top 3 or 4 inches with a disk. Lime can be worked into the soil at the same time, the amount to be used determined by testing. After these things



(Drawing: U. S. Soil Conservation Service)

Fig. 5-6. Prepare a firm seedbed, at the same time working in plenty of manure.

are done the waterway seedbed must be made firm and even. Young plants must have a firm soil for their roots if they are to live through periods of unfavorable soil conditions. This smoothing and firming can be done with a disk, spike-tooth harrow, and cultipacker. When the soil is so firm that you can hardly see your footprints, it is ready for seeding.

Use Good Seed

High quality, live seed is a necessity. Two or three times more seed should be used than would ordinarily be used for meadows. The seed must be sown shallow—

$\frac{1}{4}$ to $\frac{1}{2}$ inch deep if a drill is used, and on top of the ground if hand seeded. A mulch spread right after seeding will keep the seed in place.

Seed a Simple Mixture

The seed mixture should be simple, that is, contain only a few kinds of seed. In fact, one grass with a short-lived companion crop usually is enough. Where a number of grasses having different growth habits are used they may compete with each other until the plants of some of the species are weakened. In many places it is not advisable to use a legume. But in the South, kudzu and sericea lespedeza make excellent waterways. Cailey peas and reseeding crimson clover are also used as winter legumes on summer grasses.

Use Fertilizer to Get the Grass Started

It will be necessary to use more fertilizer in waterway seeding than is normally used in most field crops (Fig. 5-7). This is necessary to get the quick and

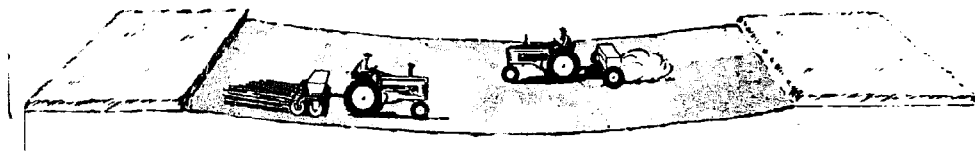

(Drawing: U. S. Soil Conservation Service)

Fig. 5-7. Put on lime and fertilizer.

vigorous growth needed for properly protecting the channel. If a drill is used for the seeding, the fertilizer can be applied with the use of a fertilizer attachment to the drill. If the seed is to be broadcast the fertilizer can be broadcast during the smoothing and firming process ahead of the seeding.

Mulch After Seeding

After seeding, spread a light mulch at the rate of 2 tons per acre. Use strawy manure, a stack bottom or straw for the mulch. After the mulch has been applied the cultipacker should be used again to cover the seed and to press the mulch into the soil.

Time of Seeding

Successful grass seedings can be made only at certain times of the year—early spring or late summer. (Get the dates for your locality from your local conservationist.)

If the waterway has been completed during early spring or late summer it should be seeded immediately. Sometimes the waterway is constructed at a time of year when seeding is not advisable. The schedule of other work on the farm frequently makes this necessary. If the waterway has been constructed too late in the spring for a spring seeding, or too late in the fall for a late summer seeding, it should be protected from damage that occurs when water concentrates during rains until the time is right for seeding. This can be done by seeding a stabilizing crop (Fig. 5-8). Corn, broadcast at the rate of 2 or 3 bushels per acre, will



(Drawing: U. S. Soil Conservation Service)

Fig. 5-8. Protect the waterway until seeding time with a stabilizing crop such as corn, planted thickly.

protect the waterway that has been built in late spring or summer. At seeding time, which in this case would be late summer, cut the corn 8 inches high and remove

the surplus growth but leave the corn stubble standing to protect the seeding. Seed the grass with little or no cultivation, depending on how hard the soil is.

For a fall stabilizing crop use oats, rye or ryegrass.

9. Protecting Waterways

Until the grass develops a strong sod the waterway will need protection to prevent damage from runoff. Until the seeding is well established no water should be allowed to flow over the grass except that which falls directly upon it. U.S.D.A. Farmers' Bulletin 1814 suggests that if the waterway is in a natural draw this may be done by plowing temporary channels along the



(Photo: U. S. Soil Conservation Service)

Fig. 5-9. This seeded waterway is protected from runoff by temporary ditches along the side of the seeded area. After the vegetation has become established the temporary ditches will be plowed in, and the runoff will then flow down the vegetated waterway.

edge to divert water down the sides of the waterway (Fig. 5-9). Later, when the sod is strong, these channels can be leveled.

Use Fertilizer and Manure to Keep Grass Strong

Apply nitrogen fertilizer or manure to the waterway often enough to maintain a dense sod. How often this is needed will depend on the soil, the location, and many other factors, but the objective is to have a healthy, dense sod.

Keep the grass in the waterway short if it is not to be mowed for hay or used for seed. A short, dense top growth of grass will carry more water without injury to the waterway than tall mature grass with stiff seed stalks. You can harvest seed from some waterways. But remember that many types of grasses provide less protection against washing when the grass is allowed to produce seed. For this reason, grass in waterways carrying heavy flow should not be allowed to produce seed. And animals, especially hogs, should never have free access to waterways.

Repair When Needed

If the grass lining of the waterway becomes damaged, repair it immediately. It will be easy when the damage is small. Each rain increases the damage and the cost and labor of putting it back in good condition.

Rills and small gullies may develop in a waterway when there is heavy runoff even when perfect seedings are established.

They are often started by some obstacle such as a rock, a broken tree limb, or weeds that cause the water to concentrate in one place and cut through the sod. Such obstacles must be removed and the scar filled. If the hole is more than 3 or 4 inches deep, soil should be

tamped firmly and then sodded with good live sod which also should be tamped in place.

Avoid Implement Damage

Always lift plows and straighten disks when crossing the waterway. (Fig. 5-10.) Plow at right angles to the waterway; never plow parallel to it. This will prevent water running along the side and starting a gully.

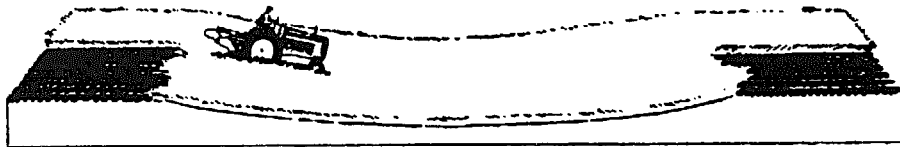

(Drawing: U. S. Soil Conservation Service)

Fig. 5-10. Lift plows when crossing waterways.

Remember, the waterway is the most critical part of the water disposal system. If it fails the rest of the system is badly weakened.

Grassed waterways have a tendency to build up with sediment. In extreme cases, the location of the waterway may be shifted to such an extent that the water flows along the edges, often starting new gullies. For this reason, the edges of a grassed waterway should be left irregular. A little care in crossing waterways with tillage implements, avoiding plowing furrows parallel to the waterway, allowing the grassed waterway to widen as the need arises, mowing to prevent excess accumulation of forage, and protection from being trampled by livestock when the ground is wet and soft will assure permanent, efficient waterways for the removal of runoff from rains of high intensity.

Chapter

VI

FARMING ON THE CONTOUR

Contour farming is an established, accepted practice. Farmers can profit most if they will follow approved practices in using this method.

A Suggested List of Activities Involving Approved Practices

1. Locating Contour Line
2. Contour Plowing
3. Planting on the Contour
4. Limitations to Contour Farming

1. Locating Contour Line

The first step in contour farming is to establish a contour guide line that runs across the field almost at a constant level. All planting or farming operations will be done from this guide line. In a relatively small field or on a uniform slope only one of these guide lines is usually necessary. On long slopes or in fields with uneven slopes, more than one guide line will be needed in order to avoid getting off the contour with the farming operations.

Use Two People

Two people are needed—one to use the level and one to be the target on which to take a sight and to set the stakes. Equipment may consist of a hand level (Fig. 3-3, Chapter III) or a small carpenter's level mounted on a T-shaped stick of light weight. (Regular engineers' levels may be used but are not necessary.) Probably the simplest method is to use the ordinary hand level. The man using the level simply finds a point on the other man that is level with his eye. This point becomes the target. (Fig 6-1.)

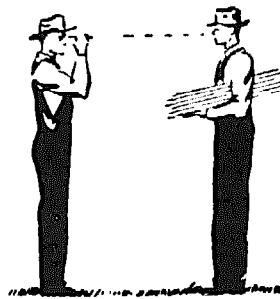

(Drawing: U. S. Soil Conservation Service)

Fig. 6-1. Levelman takes sight on helper, while both are on same elevation, to find which part of face, hat, or shoulder is level with his eye. This point becomes the target.

Start at Highest Point

In locating the first contour guide line on a slope, the usual practice is to go to the highest point in the field and then walk straight down the general slope from this point a distance of from 80 to 100 feet, depending on the steepness of the slope. On long, gentle slopes the first contour line may be 150 feet or more from the top of the hillside. On steeper slopes the distance down should be less. If only one line is needed, it is usually located half-way down the slope.

Since all the rows to be planted will be parallel to the guide line, a long slope will require additional guide

lines to prevent the rows from getting too far off the contour.

After the location of the first guide line has been selected, a stake is set and leveling is started from that position. With the levelman at the starting point, the helper paces 50 to 100 feet across the slope, staying approximately on the contour (Fig 6-2). The levelman

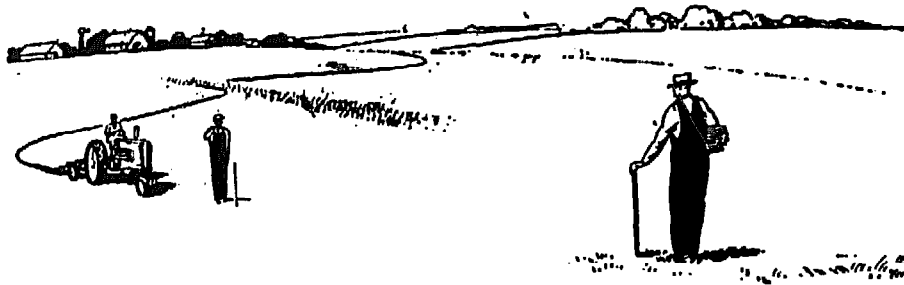

(Drawing: U. S. Soil Conservation Service)

Fig. 6-2. Levelman sights on helper to locate contour line. Plow can follow to mark the line if the men are experienced.

directs the helper up or down the slope until he is on the same level or contour as the levelman. The helper sets a stake at this position and the levelman moves to the second stake, the helper moving another 50 to 100 feet across the slope. This procedure is continued until the line crosses the field.

It is important to keep the sights short when using simple equipment such as the carpenter's level or hand level. Longer sights may be taken with engineer's levels.

Mark Contour Line Definitely

After a line of stakes is set, one man walks along the line, moving the stakes to eliminate minor irregularities, making long, smooth curves. A plow or some other tillage implement should then be used to mark

the lines more definitely. A shallow plow furrow will be visible much longer than a row of stakes.

The following drawings illustrate some of the different situations that may be encountered in laying out contouring:

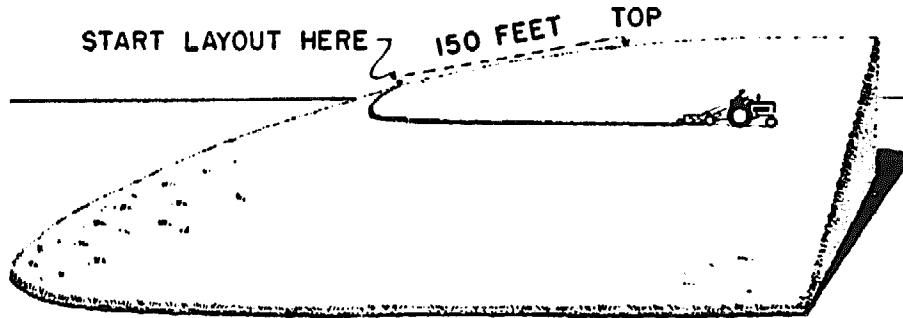

(Drawing: U. S. Soil Conservation Service)

Fig. 6-3. Layout for slope that is regular and even.

If the field has about the same slope all along the proposed contour line and is not over 300 feet from top to bottom, use one contour line one-third of the way down (Fig. 6-3). If the slope is longer than 300 feet, locate the line 150 feet from the top and use an additional line every 200 feet below.

If the slope is irregular (Fig. 6-4), walk to the steepest place and start the first line about one-third of the

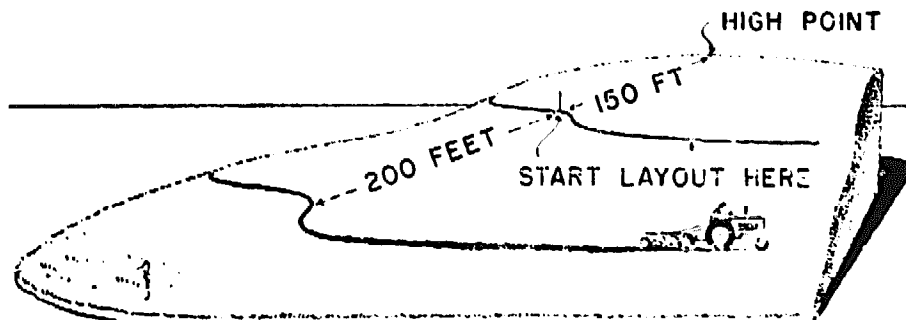

(Drawing: U. S. Soil Conservation Service)

Fig. 6-4. On irregular slopes, start at steepest place and use additional lines.

way down (or 150 feet down if the slope is longer than 300 feet). Use an additional line about each 200 feet below if the slope is long enough.

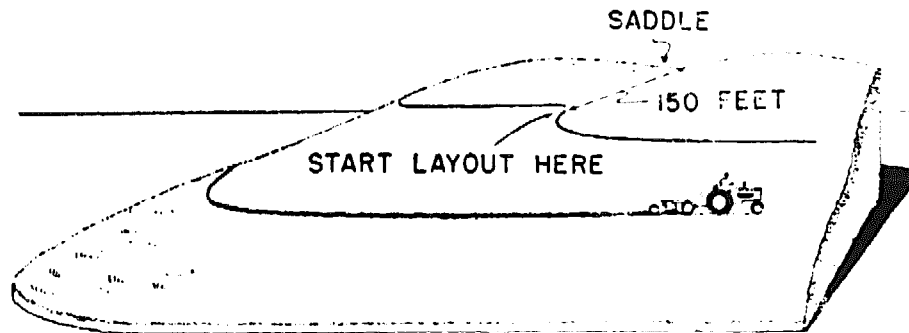

(Drawing: U. S. Soil Conservation Service)

Fig. 6-5. Layout for slope with saddle.

If there is a saddle in the ridge top (Fig. 6-5), start the first contour line about 150 feet below the "seat" of the saddle. Other lines may be needed above for high point areas.

2. Contour Plowing

While many fields are laid out for contour planting after the land has been plowed and prepared, full benefits from contouring are obtained only if all operations are on the contour. This means that the first operation should be to plow the field on the contour.

Plow to Common Plan

The best plan is to start back furrows on the contour lines and work around them until the plowed areas are about 100 feet wide or until end travel is excessive (Fig. 6-6). Then plow around the unplowed land between the contour lines. When the unplowed land is just wide enough to turn on at the narrowest point, start turning back by cutting across at the narrow

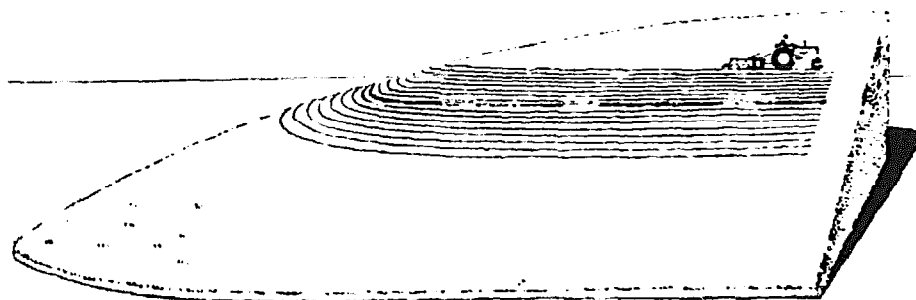

(Drawing: U. S. Soil Conservation Service)

Fig. 6-6. Plow the first furrow on the contour guide line.

point. Keep turning back until the entire land is brought to turn-strip width. Then finish by plowing out the strip.

The following sketches (Figs. 6-7, 6-8, and 6-9) illustrate how to finish up plowing where two contoured lands come together. This situation could occur on a ridge top or on a slope where two or more guide lines are used. This method will eliminate turning on plowed ground and leave a deadfurrow approximately on the contour.

Plows should be lifted when crossing waterways. Open furrows should not be left parallel to the waterway. In plowing meadow land, inexperienced operators should mark the edges of the waterways with a shallow scratch furrow far enough back to be erased in plowing and to form an irregular plowed edge.

3. Planting on the Contour

In preparing the seedbed and planting small grain and row crops, follow the same general plan as in plowing. If the field has been plowed before contouring was planned, then guide lines may be marked out for disk-ing, drilling or planting.

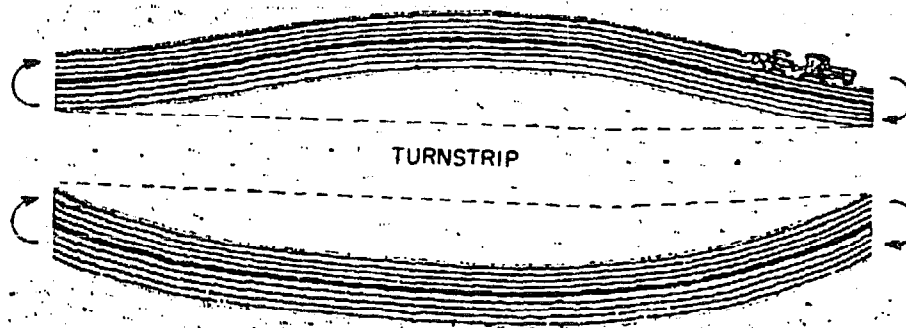

Step 1. Use each contour line as a backfurrow and plow around each of these lines until the area left is narrow enough to work around without too much waste of travel at the ends or until a turn strip wide enough for turning the tractor is left at the narrowest point.

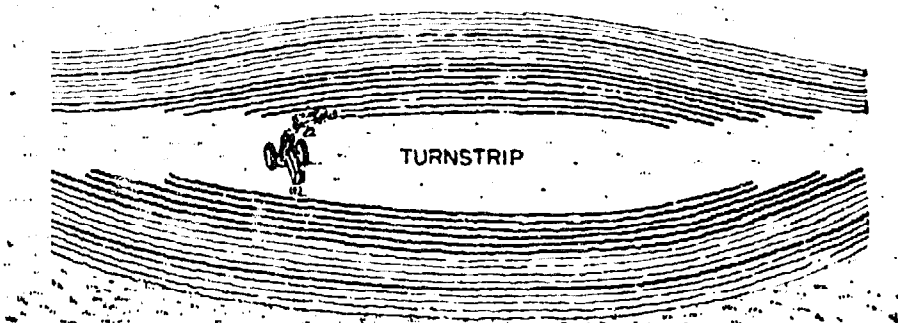

Step 2. Plow around the irregular area leaving a turn strip at the narrowest part wide enough to turn your tractor. Then begin turning back by cutting across the land at these narrow points. Continue this process until all unplowed land is the same width.

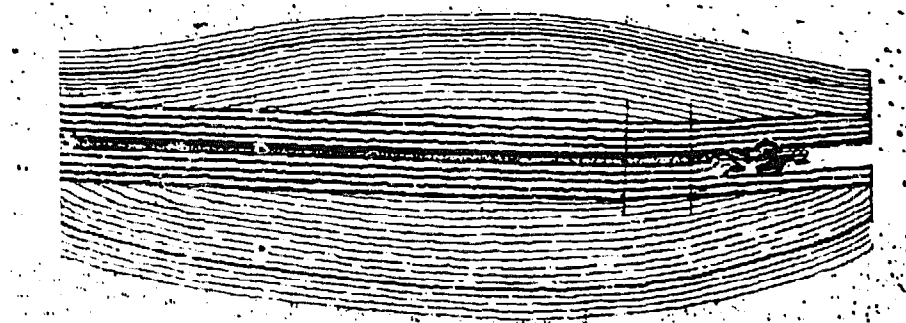

Step 3. Plow the entire strip as a land, leaving a full-length deadfurrow through the center, or leave the strip in grass if it is sloping enough to cause an erosion problem. By shifting the location of the key contour lines, deadfurrows and ridges will not occur in the same place twice.

(Drawing: U. S. Soil Conservation Service)

Fig. 6-7. Plowing out field where two contoured lands come together.

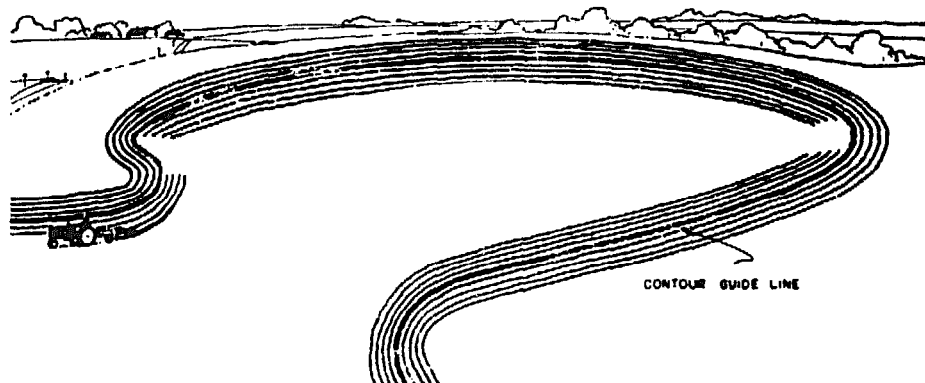

Step 1. Situations like this are sometimes found at the top of a ridge. Handle them by plowing around the top contour guide line as shown above. If the inside curves get too sharp, lift the plow and leave a strip wide enough to enable you to turn easily.

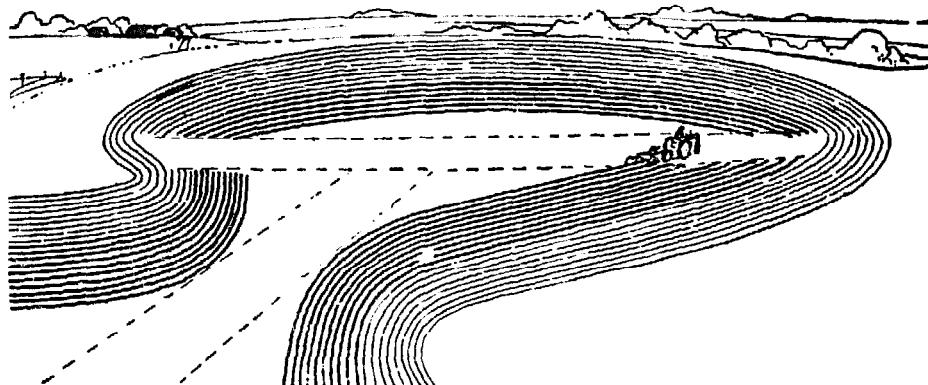

Step 2. After plowing around the contour line several times, start plowing on the inside of the area. If a field boundary is encountered, follow it to get back to the starting point. Continue to lift the plow out of the ground on the sharp curves. You may also want to lift the plow at the narrow neck. This would be done as long as it is faster to run idle across the neck than to turn back.

(Drawing: U. S. Soil Conservation Service)

Fig. 6-8. Plowing out an irregular ridge top.

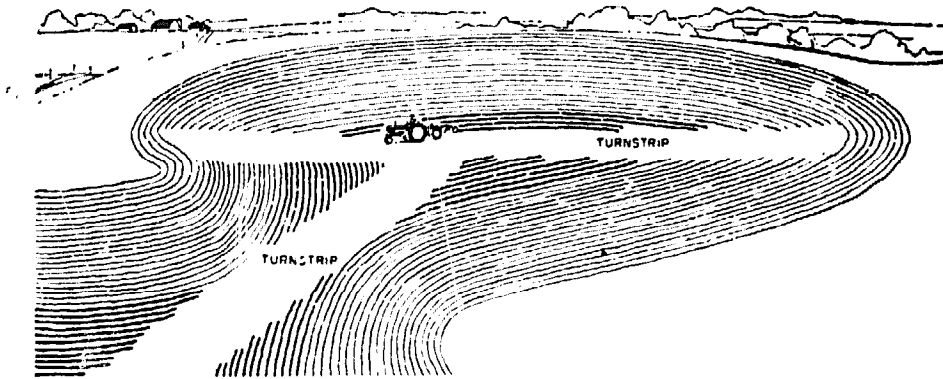

Step 3. Continue from Step 2 by plowing out the area, leaving the strip mentioned in Step 1 wide enough to turn easily throughout the strip. This strip will be treated later. Keep on lifting the plow on the sharp turns as stated in Step 2. This will result in a T-shaped strip.

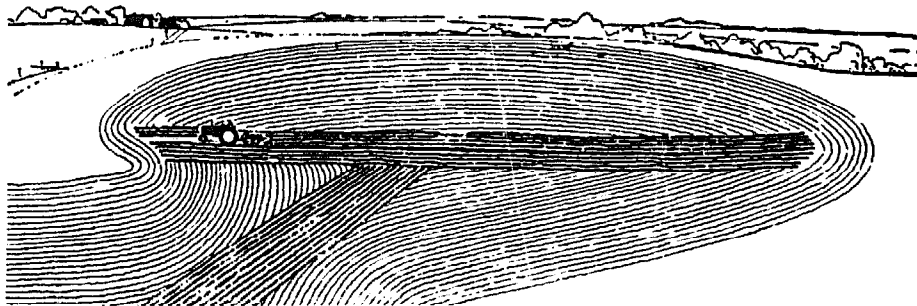

Step 4. Plow out the middle turn strip first and then the strip left by lifting the plow on the sharp curves. This will be the only time that it will be necessary to turn on loose ground and this will be for only three or four short rounds. The two strips can be left in grass if desired.

Fig. 6-8 (Continued)

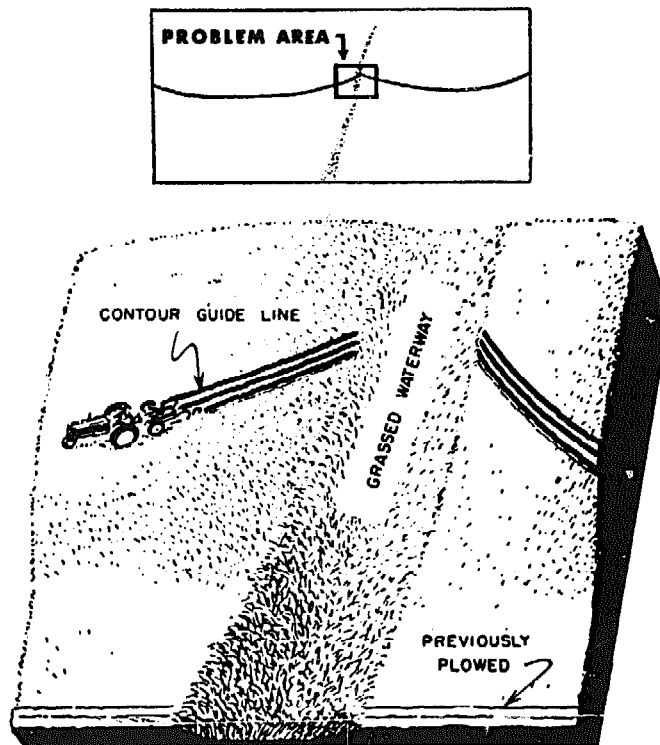

Step 1. Because of the slope at the waterway, the contour guide line tends to double back rather sharply.

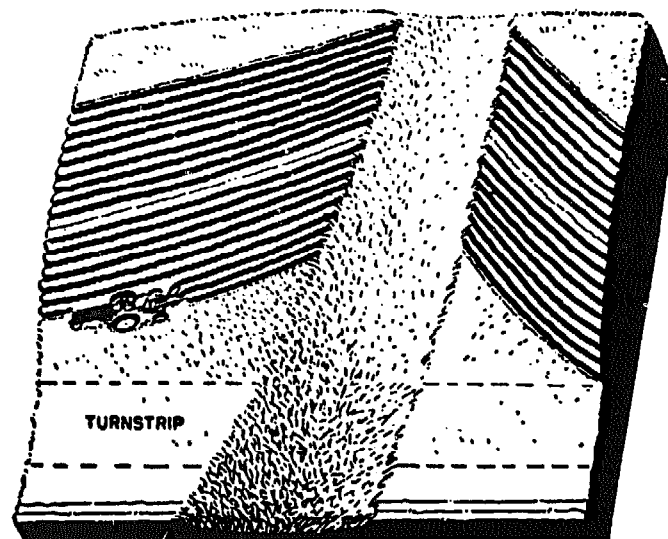

Step 2. Plow a regular land around the contour guide line, lifting the plow from the ground when crossing the waterway.

(Drawing: U. S. Soil Conservation Service)

Fig. 6-9. Plowing where contour rows cross a waterway.

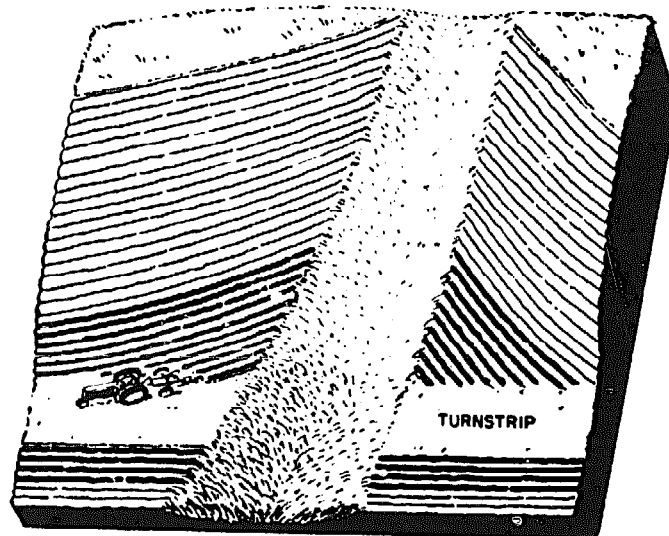

Step 3. Continue plowing but leave a turn strip at the lower part of the field.

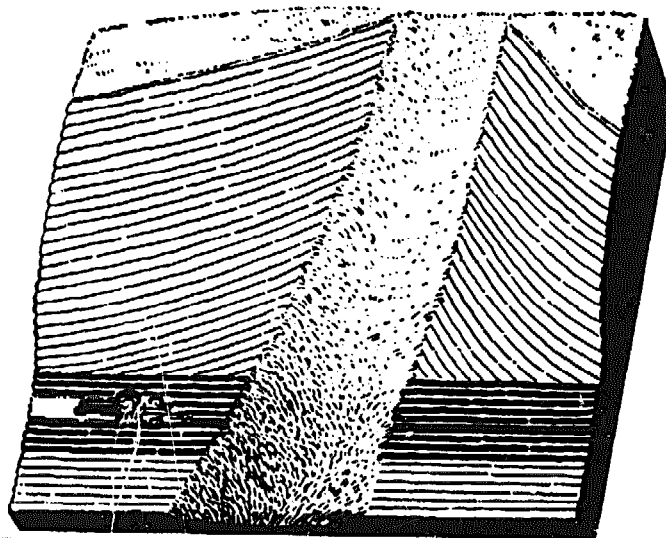

Step 4. Either plow out the strip or leave it in grass.

Fig. 6-9. (Continued)

Plant According to Way Crop Will Be Harvested

Before contour planting is started, some consideration should be given to the way the crop is to be harvested, especially if corn is to be picked with a picker or soybeans are to be combined. Most machine operators like to have the point rows planted so that they can be harvested last.

To start planting, follow the top contour guide line and plant uphill until the slope above is planted (Fig. 6-10). Next start at the lower side of the same contour line and plant about half-way to the line below, at the narrowest point. Now start at the second contour line

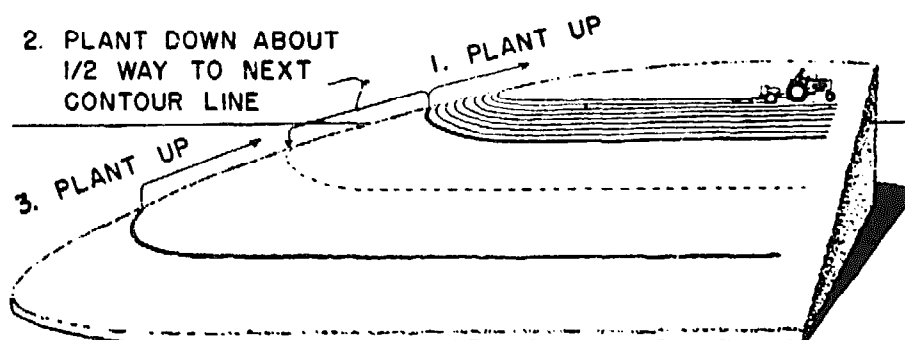

(Drawing: U. S. Soil Conservation Service)

Fig. 6-10. Planting row crops from a contour guide line.

and plant uphill until you reach the rows at the narrow point. Finish by planting the short rows. Another way to do this is the turn-strip method suggested for plowing. The turn rows, usually 8, are planted first except for hard ground listing.

In cultivating row crops, follow the planter patterns. (Fig. 6-11). Other farming operations, including harvesting, are easier on equipment if done on the contour. (Fig. 6-12.)



(Photo: U. S. Soil Conservation Service)

Fig. 6-11. In cultivating, follow the planter pattern. Cultivate the long rows first.

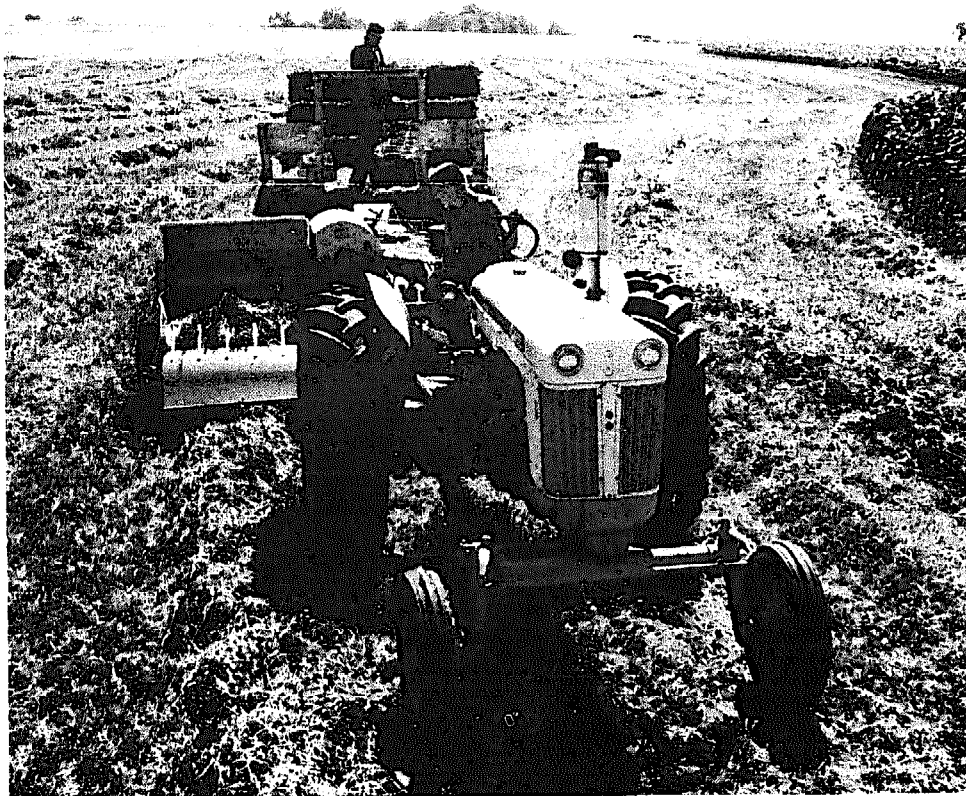

(Photo: U. S. Soil Conservation Service)

Fig. 6-12. Following the contour with haying equipment.

4. Limitations to Contour Farming

Contour farming does best on fields that slope uniformly in one or two directions. It is usually impractical on fields having irregular topography with great variations in slope.

Grass waterways must be used in conjunction with contour cultivation—in all drains or drainageways where gullies tend to start.

Chapter

VII

CONTOUR FENCES

There are occasions where a contour fence will help in making the soil conservation plan on the farm more effective. The separation of pasture land from cropland where the slope changes from gently rolling to steeply rolling or steep is one example. Contour fences make good guide lines for the planting of crops on the contour.

In certain parts of the country living fences may be used. Multiflora rose is one example.

Contour fences made of the conventional fencing materials are also used but require special methods of construction to keep them tight. (Fig. 7-1.)

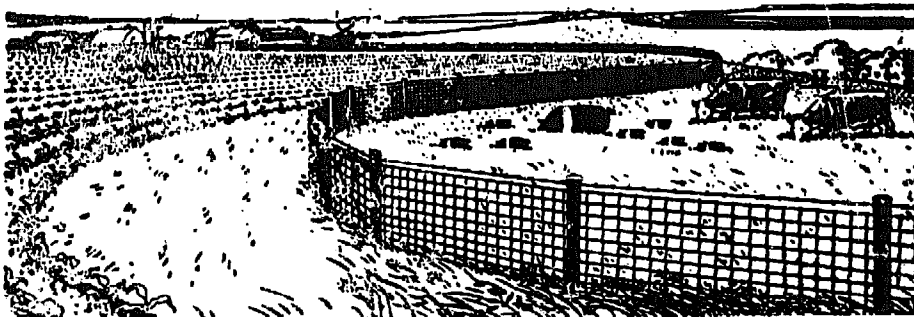

(Drawing: U. S. Soil Conservation Service)

Fig. 7-1. Contour woven wire fencing showing interior braces.

A Suggested List of Activities Involving Approved Practices

1. Laying Out Fences
2. Setting Posts
3. Assembling End Posts
4. Placing and Stretching Wire

Ohio Research Circular No. 5, "Contour Fencing," describes the following method of building contour fences:

1. Laying Out the Fences

The fence line should be laid out in a smooth curve. Where the contour line makes an abrupt turn, smooth out the turn. This not only will help in building the fence but will make it more useful as a guide to planting later.

Set stakes $16\frac{1}{2}$ feet apart. After the entire fence has been staked out in this manner check the curvature of the line to see if some posts will need to be closer than $16\frac{1}{2}$ feet. Do this by selecting three consecutive stakes

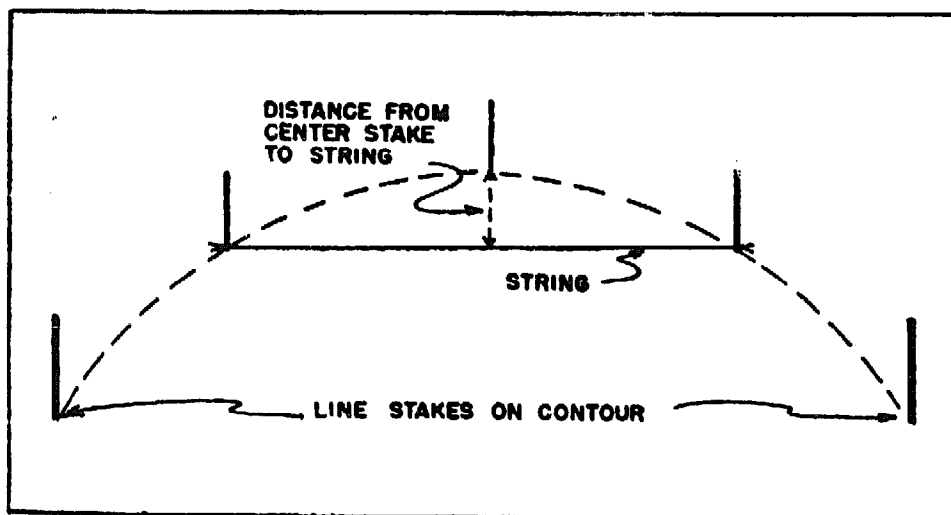

(Drawing: Ohio Agricultural Experiment Station)

Fig. 7-2. Measuring fence curvature to determine post spacing.

in any section of the fence. Stretch a string between the first and third stakes. Measure the distance from the center stake to the string as illustrated in Figure 7-2. Repeat this operation whenever the curve appears to change appreciably. If this distance is 4 inches or less, the fence posts can be put in at the stake spacing—16½ feet apart. If this distance is greater than 4 inches, the posts should be spaced closer than 16½ feet.

TABLE 7-1. Table of recommended post spacings.

Distance of Center Stake to String	Recommended Post Spacing
(Inches)	(Feet)
4 or less	16½
4 - 5	15
5 - 6	14
6 - 8	12
8 - 14	10
14 - 20	8

Example: If this distance of the center of three consecutive posts measured 5½ inches, the line posts should be spaced 14 feet apart. If the distance were 10 inches, the post spacing would be 10 feet.

(From Ohio Research Circular 5)

According to Table 7-1, place the stakes at the proper spacing and check by eye to see that no single post is out of the line of a smooth curve. Fence wire should then pull equally against each post.

2. Setting Posts

Steel posts should be 6½ feet long with the usual brace plates. Other line posts should be 7 feet long. Steel posts should be in the ground 26 inches, and wood posts should be in the ground at least 36 inches. Where

MINIMUM DIAMETER OF POSTS 7 INCHES

NOTCH CUT 1 INCH DEEP OR TO HEARTWOOD AND PAINTED

BRACE: 4 INCHES MINIMUM IF SAWED OR SPLIT, 6 INCHES MINIMUM IF ROUND POLE IS USED. 7 FEET 6 INCHES LONG

"DEAD MAN"
USE AS ALTERNATIVE

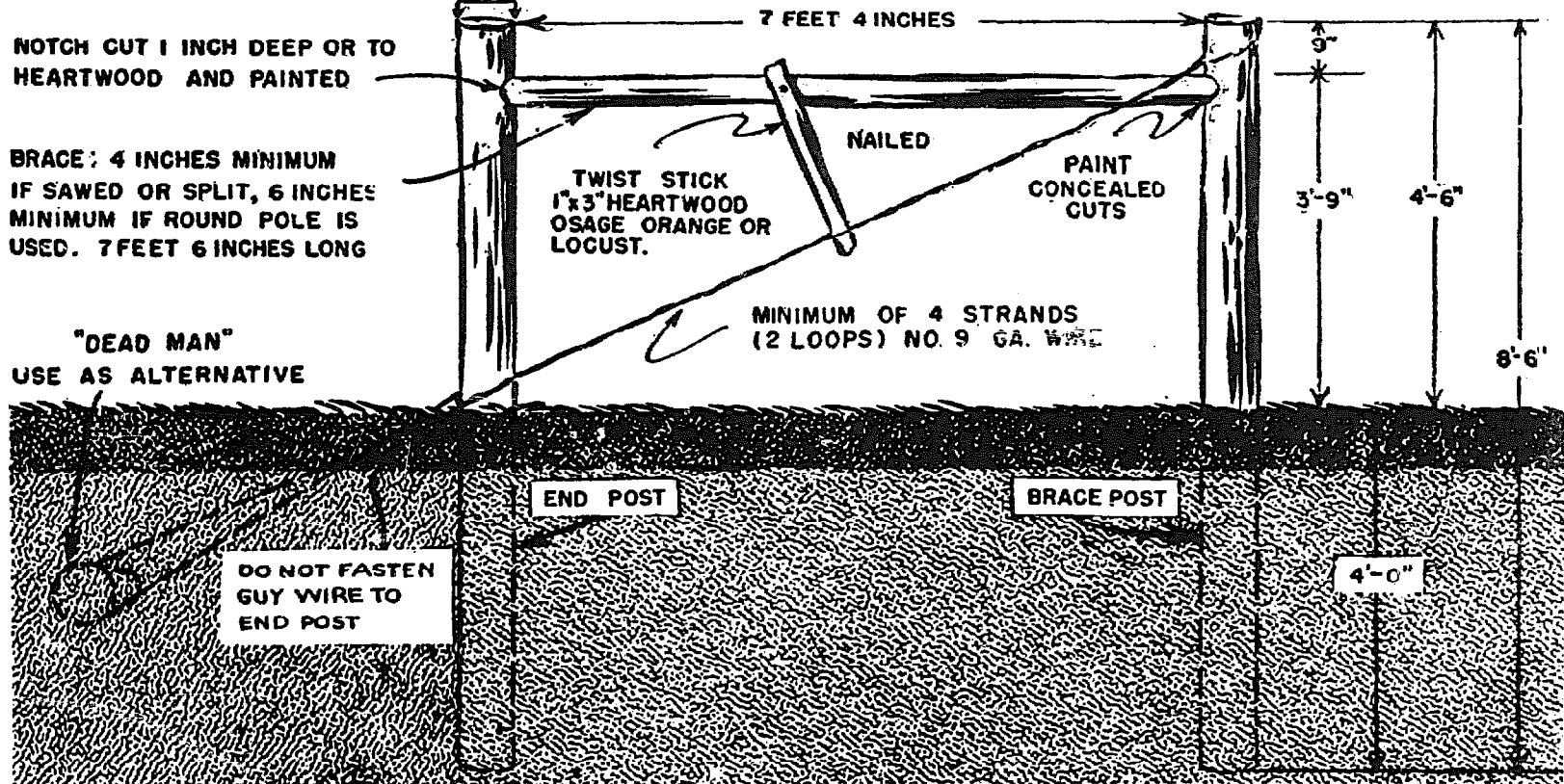

(Drawing: U. S. Soil Conservation Service)

Fig. 7-3. One method of bracing an end post.

winter weather (heavage) is a problem, length of posts should be 7 feet for steel and 7½ feet for wood posts.

Turn Crooked Posts Till Parallel

When driving or setting posts, turn all crooked posts until crooks are parallel to the line of fence and lean the top out about 2 inches. When the wire is stretched, the posts will tend to straighten up to a plumb position.

3. Assembling End Posts

Use regular system of bracing at ends of a stretch of wire. Figure 7-3 illustrates one method of constructing an end post brace assembly.

Use Interior Braces

Use additional braces in the fence lines at about 15-rod intervals. If the fence is stretched in 10-rod sections, place interior braces at these points. Figure 7-4 shows a type of interior fence bracing. Figure 7-5 illustrates a method of putting brace plates on wooden posts.

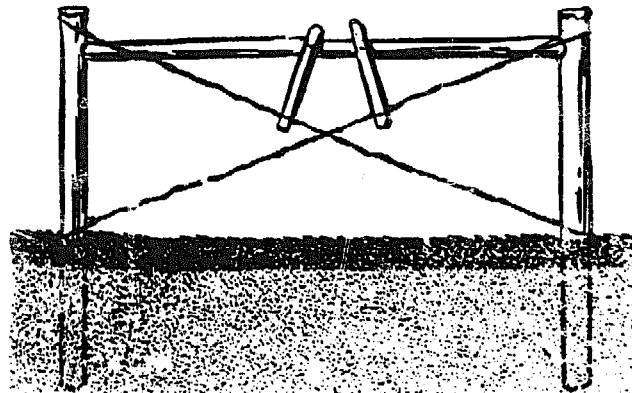

(Drawing: U. S. Soil Conservation Service)

Fig. 7-4. Interior brace.

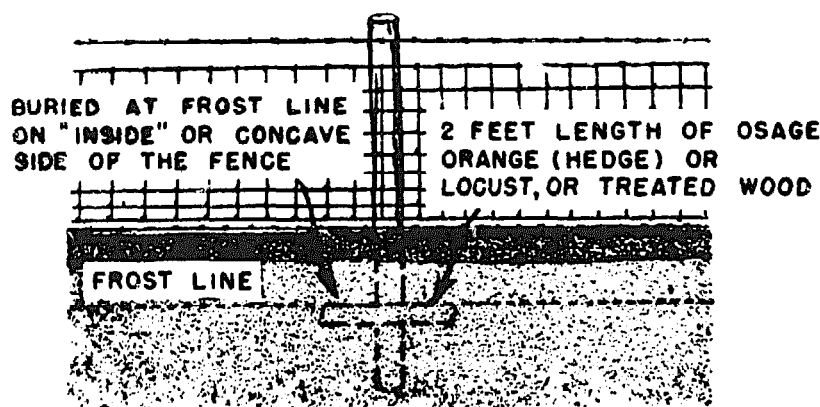

(Drawing: U. S. Soil Conservation Service)

Fig. 7-5. Brace plate on wooden post.

4. Placing and Stretching Wire

Always put wire fence on the outside of the posts on the curve so it pulls against the posts. (Fig. 7-6.)

Fasten the end of the roll to the end post and roll the wire out on the ground along the fence line. Pull the

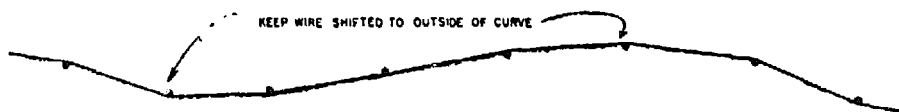

Fig. 7-6. Illustration showing placing of wire on outside of posts on curve.

wire up by hand until it clings against the fence posts. Attach stretchers and stretch just enough to prevent sagging. A curved fence needs less tension than a straight fence. The sharper the curve the less tension should be applied.

Pull Evenly

When stretching the fence, go along it several times

releasing it when it catches on the posts. On sharp curves it may be necessary to stretch in 10-rod sections, otherwise, 20- to 40-rod stretches are satisfactory. When crossing draws or waterways place one or more strands of barbed wire under the fence rather than trying to sag the woven wire into the draw or waterway.

Construction of contour fences is not difficult; in fact it is easier than building a straight fence over uneven ground. This is because tension of the top and bottom wires is equal in a fence built on the contour. Also, there is no tendency to lift posts as there is in crossing a low spot.

Chapter

VIII

STRIP CROP FARMING

Strip cropping has proved of considerable value in helping to control erosion on certain soils and topography. Combined with good crop rotations, it is effective in reducing erosion on land where terraces are not practical because of uneven slope, or other topographic features.

In some parts of the country, strip cropping is about one-half as effective in controlling erosion as are terraces, other things being equal. Strip cropping is about twice as effective as contouring alone, again with some exceptions. (Table 8-1.) Strip cropping does not have the effect of reducing the effective length of slope as does terracing. Therefore, it is most effective on slopes that are not too long. For example, at the LaCrosse, Wisconsin, Soil Conservation Experiment Station, it was found that on slopes of 10 to 12 per cent, strips that are receiving runoff from watersheds more than 250 to 300 feet long will have high soil losses when the lower slopes are in corn or grain. Terraces must be used to reduce the length of long slopes.

There are four general kinds of strip cropping: (1) Contour strip cropping, (2) field strip cropping,

TABLE 8-1.

Crop	Contoured		Strip Cropped	
	Water loss	Soil loss per acre	Water loss	Soil loss per acre
	Inches	Tons	Inches	Tons
Corn.....	1.2	6.4	1.2	3.4
Grain.....	1.8	1.2	1.4	.5
First-year hay.....	1.4	.1	1.5	.2
Second-year hay.....	.8	.1	1.0	.2
Average.....	1.3	2.0	1.3	1.1

Soil and water losses from contoured and strip-cropped plots.
(U. S. Soil Conservation Service Technical Bulletin No. 973, Report Upper
Mississippi Valley Conservation Experiment Station, LaCrosse, Wisconsin)

(3) wind strip cropping, and (4) buffer strip cropping, according to U.S.D.A. Farmers' Bulletin No. 1981.

(1) In contour strip cropping, the crops are arranged in strips or bands on the contour at right angles to the natural slope of the land. Crops are grown on these strips in a definite rotational sequence, although all of the crops in the rotation need not be in the same field in the same year. The balance in the rotation can be obtained by using other fields that may or may not be strip-cropped. For example, in a four-year rotation of corn, grain and two years of meadow, corn strips alternating with first year meadow strips will appear on one particular field in a given year and grain and second year meadow will appear on another field. (Figs. 8-1 and 8-2.)

(2) In field strip cropping, the strips are of uniform width and are placed across the general slope but do not curve to conform to the contour. Field strip cropping is recommended only where the topography is too irregular or undulating to make contour strip cropping practical. (Fig. 8-3.)

(3) In wind strip cropping, the strips are uniform in width, usually straight and laid out *across* the direc-



(Photo: U. S. Soil Conservation Service)

Fig. 8-1. Contour strip cropping in Iowa.

tion of the prevailing winds. It is recommended on level or nearly level land where wind erosion is the important hazard. (Figs. 8-4 and 8-5.)

(4) In buffer strip cropping, strips of grass or legume crops are laid out between even width strips of crops in regular rotations. The grass strips are usually of uneven width; they make up the "correction" necessary to making the crop strips even. They are more or less permanent and make it possible for the remainder of the field to be planted in the same crop. (Figs. 8-6 and 8-7.)

The kind of strip cropping to be used depends on a number of local conditions, such as the kinds of crops that can be grown, the kind of erosion (wind or water), and the physical characteristics of the soil.

A Suggested List of Activities Involving Approved Practices

1. Laying Out Contour Strip Cropping



(Photo: U. S. Soil Conservation Service)

Fig. 8-2. Contour strip cropping in Texas

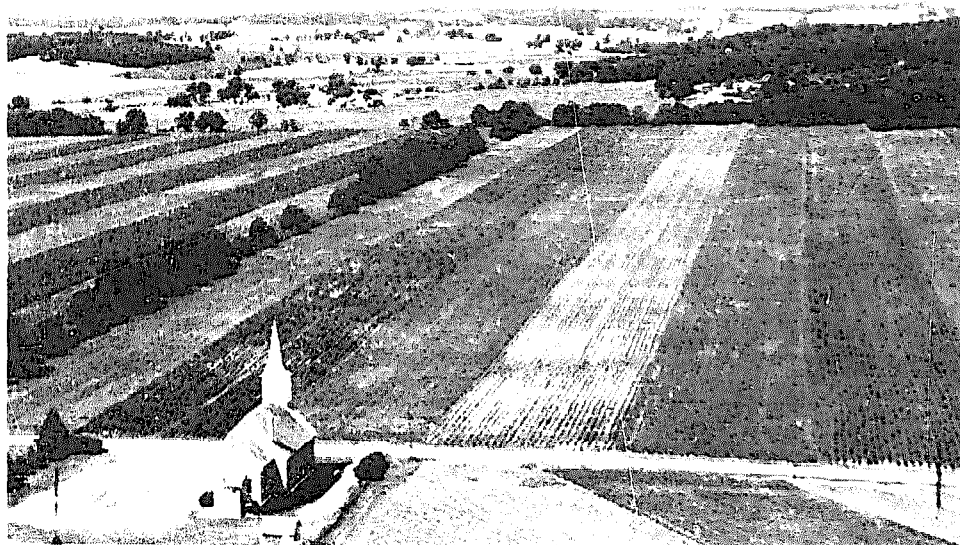

(Photo: U. S. Soil Conservation Service)

Fig. 8-3. Field strip cropping in Wisconsin.



(Photo: U. S. Soil Conservation Service)

Fig. 8-4. Wind strip cropping in Michigan.



(Photo: U. S. Soil Conservation Service)

Fig. 8-5. Wind strip cropping in North Dakota.

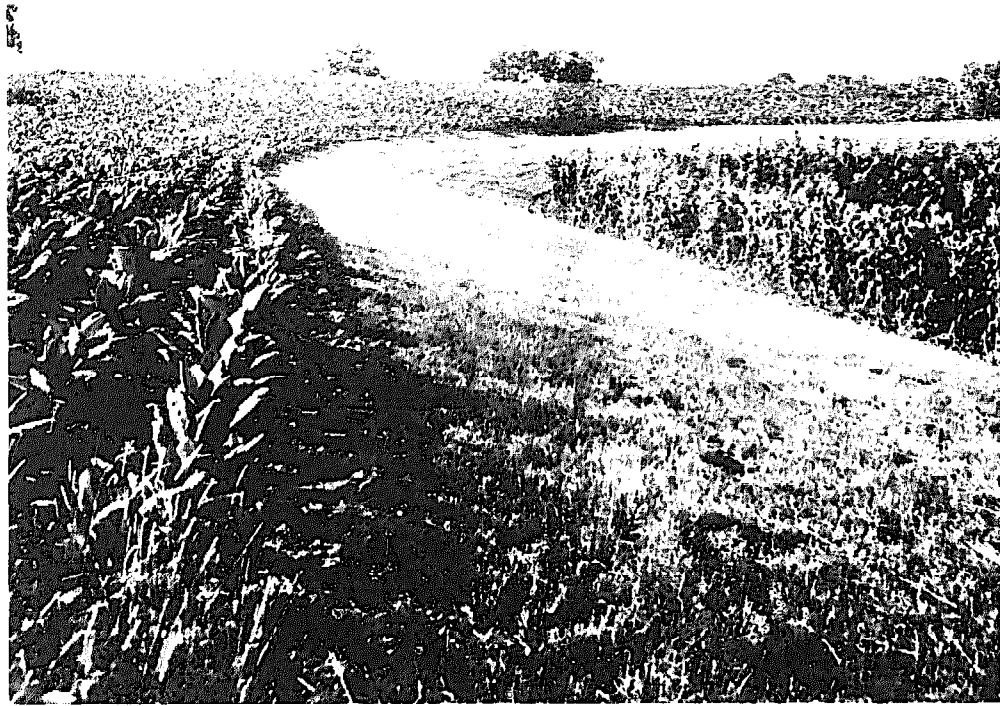

(Photo: U. S. Soil Conservation Service)

Fig. 8-6. Buffer strips of bluegrass and timothy between corn and tobacco in Kentucky.



(Photo: U. S. Soil Conservation Service)

Fig. 8-7. Buffer strips of meadow between cotton in Texas.

2. Laying Out Wind Strip Cropping, Field Strip Cropping and Buffer Strip Cropping
3. Farming Strip-Cropped Fields

1. Laying Out Contour Strip Cropping

There are many ways of laying out contour strip cropping. Three general methods will be discussed:

- (1) Both edges of the strips on the contour.
- (2) One or more even-width strips laid out from a key or base contour line.
- (3) Alternate, even and irregular-width strips.

In the Northeastern States a graded type of strip cropping is used on sloping lands that are poorly drained yet subject to severe erosion during the summer when heavy rains occur. This method lets the rows drain toward waterways, removing the excess moisture during portions of the year when the soils are wet and cold.

Lay Out One Contour Line

Regardless of the method used, one or more contour lines must be laid out on each field to be strip cropped. For this work some kind of a level is needed; a surveyor's level, a farm level, an inexpensive hand level, or even a carpenter's level may be used with satisfactory results. (See Chapter VI on Contouring.)

There is no set rule as to where to lay out the first contour line. Some start at the middle of the slope and lay out as many of the longest strips as possible, leaving the odd or irregular areas to work themselves out at both the top and bottom of the field.

Some start at the top of the field and lay out one strip after another down the slope. Some operators reverse the procedure and start at the bottom of the

field. There is no set rule. The general topography is probably the most important factor.

(1) Both upper and lower edge of strip on the contour.

When the strip-cropping system is laid out so that both the upper and lower edges of the strips are on the contour, all strips are irregular in width. This is true because a perfectly uniform slope is not found.

Uneven width strips need not be considered a serious disadvantage. Many farmers throughout the country are accustomed to farming on the contour, farming terraced land, or strip-cropped land, where it is necessary to have point rows in the middle of fields. They do not find it objectionable, particularly in view of the benefits such as saving of moisture, prevention of soil loss, and higher yields. The important feature in contour strip cropping is the planting, and thus the cultivation, of the row crops on the contour. This means that with this method of strip layout the planting will be done from both edges toward the middle. If planting is done from one side with the short rows coming on the lower or upper side of the strip, some of the rows can easily be 5 to 7 per cent off contour, thus concentrating water which causes breaking through the rows and starting gullies.

Planting from both sides gives the maximum number of long rows, puts the short rows in the center where they can be harvested with present day equipment better, puts the greatest number of rows on the contour, eliminates turning on adjacent crops, and gives much better control of water movement. If planting does not follow the contour edges it is usually better to use even-width strips and take the expected amount of erosion.

On fairly uniform slopes, the width of the strips is fairly uniform. But where the degree of slope varies widely, the width of strips varies considerably. Strips

will be narrow on the steeper slopes and wider on the more gentle areas.

(2) One or more even-width strips laid out from a key or base contour line.

When the difference in the width of strips varies too much, operators may prefer using some uneven-width strips between sets of even-width strips. Several even-width strips may be laid out from a key or base contour line. When the strips begin getting too far off the contour, as will certainly happen, an irregular-width strip may be put in to take up the correction. Then more even-width strips may be laid out.

The irregular strips may be left in sod or meadow or may be farmed in the regular rotation. This method has the advantage of providing some even-width strips that can be farmed without point rows, but all farming operations are not on the true contour.

Minnesota Extension Folder 108 suggests the following steps in laying out contour strips where several even-width strips are separated by a strip of irregular width to take up the correction:

1. Locate the first contour line far enough down the slope to leave one strip above it. This strip should be below the contour pasture fence if the field is in a valley, or below the ridge if the field is on ridge land. Use instruments and methods as outlined in Chapter VI on Contouring.
2. Lay out a second strip below the contour line and then check the lower side to see how far it is off the contour.
3. If the lower side of the second strip is not off more than 2 per cent for a distance of 50 feet or less, lay out a third strip and again check lower side.
4. Whenever the lower side is too far off the contour, run a new contour line far enough below

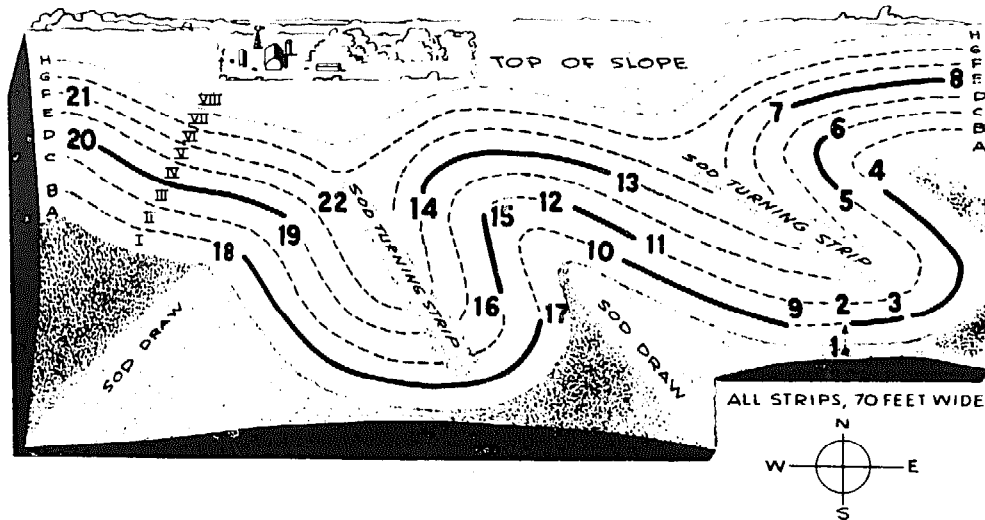
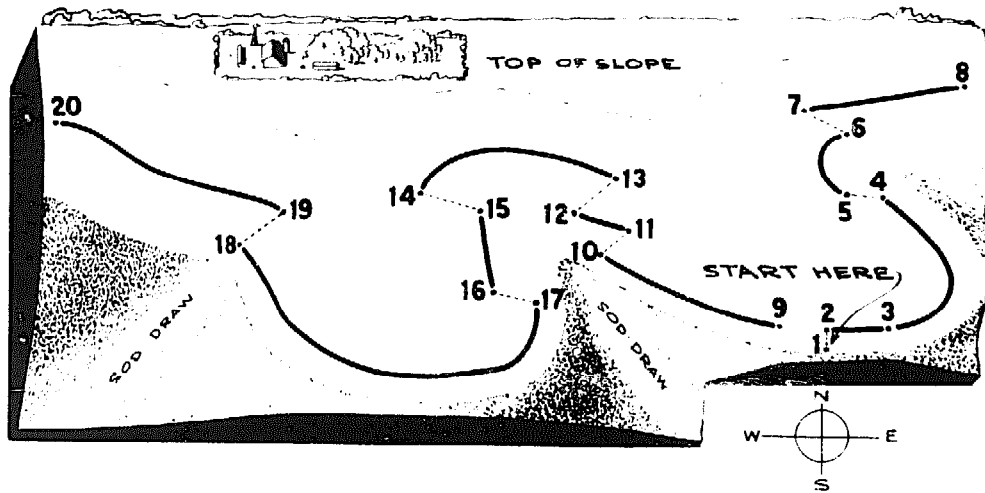

(Drawing: U. S. Soil Conservation Service)

Fig. 8-8. Parallel strips laid out from a key contour line. The line is always in the predominant slope condition.

in this case is at point 4. Move up the slope 70 feet to point 5 which will be more nearly in the center of the predominant slope at that point. Run a contour line to 6, move uphill 140 feet to point 7, and run a contour line to the fence at point 8.

In staking the strips parallel to the key contour line, two men use a rope the length of the strip intervals or multiples of it. In this case 70 or 140 foot lengths are needed.

Go back to point 1 and measure the width of the strip toward point 9 continuing as far as the slope will permit as before. Run a contour line from 9 to 10. Measure uphill 70 feet to 11 and continue to 12 on the contour. Measure up slope 140 feet to 13, the center of the predominant slope, and on the contour to 14. Continue to follow this procedure of up or down as the numbers on the sketch indicate until number 20 is reached. Now the contour lines have been staked as shown by the heavy black lines.

Staking the strips now becomes a matter of measuring from the key line. With practice, short cuts can be found to speed up the layout. For examples, line F between points 21 and 22 can be staked by measuring 140 feet up slope from line D. By handling a 140 foot length of rope, this is all the staking that will be necessary. After line F is staked, lines E and G can be marked with a plow simply by tying a 70 foot rope on the front of the tractor. One man walks the stake line and the tractor operator plows the other line, keeping the line taut. Some rounding off will be necessary at draws and on the ridges at turn strips.

(3) Alternating each even-width strip with an irregular strip.

The third method provides for alternating each even-width strip with a strip of irregular width. From the first contour line, which can be staked from any point in the field, an even-width strip is measured out above the contour line. The second contour line is staked at a distance equal approximately to the width of two strips either above or below the first contour line. An even-width strip is then measured out above this second contour line. This process is repeated until the entire field has been laid out in a strip-cropping system.

When this method is used, each contour line forms

the lower boundary of an even-width strip and the upper boundary of the adjoining irregular-width strip.

Establish contour strips by plowing out on a hay-field or by seeding every other strip to a legume and grass mixture. This may be done gradually by seeding a new strip every year.

Width of Strips

Width of strips varies with degree and length of slope, the permeability of the soil, the susceptibility to erosion, the amount and intensity of rainfall, kinds and arrangement of crops in the rotation, and the size of farm equipment. In the humid regions, strips from 60 to 150 feet in width are in use. Minnesota Extension Folder 108 gives the following table for determining width of contour strips (Table 8-2):

TABLE 8-2. Determining width of strips.

Amount of Slope	Width of Strips		
	Good Soil	Fair	Poor Soil
Percent	Feet	Feet	Feet
4-10	125	100	75
10-15	100	75	60
15-20	60	60	60

(From Minnesota Ext. Folder 108)

If field is severely eroded lay out strips 15 feet narrower than listed except for slopes of 15 to 20 per cent which should be seeded to permanent hay or pasture.

2. Laying Out Wind Strip Cropping, Field Strip Cropping and Buffer Strip Cropping

In wind strip cropping, even-width strips are laid

crosswise to the direction of the prevailing winds. The strip boundaries are usually marked by stakes in the fence rows. Strips should be of the proper width to assure efficient use of the farm equipment. Similarly, in field strip cropping, the strips are laid crosswise to the general slope, even in width and parallel.

The location of buffer strips is determined largely by the width and the arrangement of adjoining strips to be cropped in rotation, and by the location of steep, badly eroded areas on slopes. On sloping land, buffer strips usually include the correction areas.

Area of Strips

Table 8-3 may be used for computing the area of strips. This information is usually valuable in estimating yields and planning crop rotations.

3. Farming Strip-Cropped Fields

After strips are laid out, they should be farmed in a crop rotation that will control erosion. It is best not to plan on pasturing strips since it is difficult to arrange fields for this purpose. Crops may be arranged so that the meadow crops can be grazed if pasture is needed, however. If this is done, do not overgraze and damage the meadow, which will reduce its value for hay the following year. Several factors need to be considered in fitting the rotation and the strips together so that crop balance, convenience of farming, pasturing, insect control, and other problems are solved.

U.S.D.A. Farmers' Bulletin No. 1981 says crop damage from chinchbugs can often be avoided by growing corn and meadow and small grain and meadow in alternating strips in separate fields. This arrangement of row crops and small grain by fields requires no special planning to avoid damage from chinchbugs since it

TABLE 8-3. For computing areas of strips.

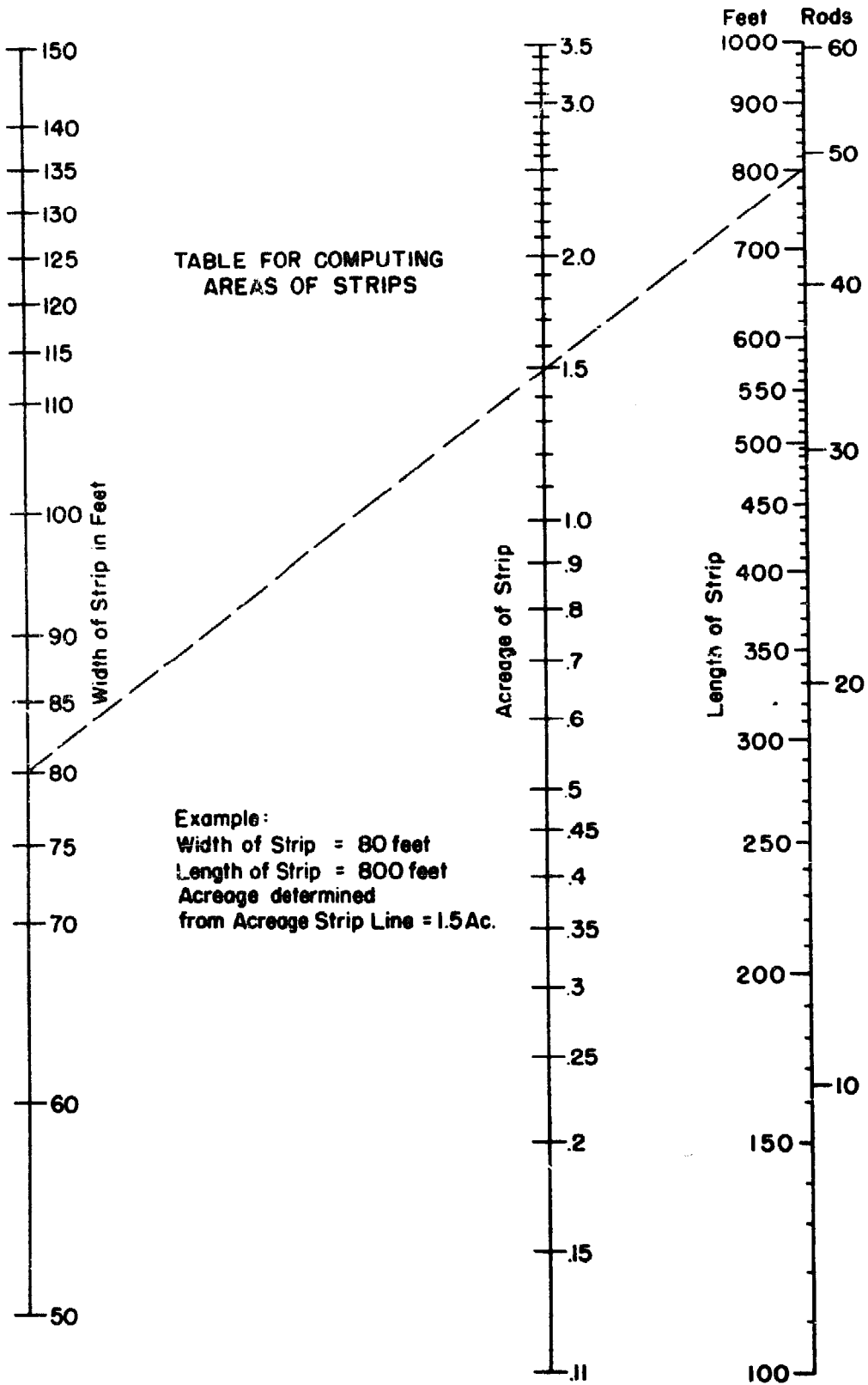

(From U. S. Soil Conservation Service)

eliminates bordering of corn and small grain and does not increase the difficulty of application of control measures where they may become necessary. This same grouping of crops lessens the likelihood of crop damage from hot winds. Also, where sorghums can be used to replace corn in the cropping system, the probability of damage from hot winds is much less.

Control Grasshoppers

Tillage and distribution of poison bait are the principal measures used in controlling grasshoppers on strip-cropped fields. Where infestations are local and small, baiting alone may provide adequate control. Whenever headlands, field borders, and buffer strips are sources of infestation, they should be baited early to kill grasshoppers before they migrate to adjoining crops. Small-grain stubble strips joining fallow strips to be seeded to winter wheat should be baited when necessary before the winter wheat is seeded. Where sorghums and wheat are both grown after fallow in the cropping system, an arrangement of crops by strips and fields so that sorghum strips alternate with the fallow strips to be seeded to winter wheat and the winter wheat strips alternate with fallow to be planted to sorghum reduces the likelihood of grasshopper damage.

Destroy Grasshopper Eggs

Fall or early spring tillage of stubble strips will destroy many grasshopper eggs by exposing them to freezing and drying or by burying them so deeply that the hoppers cannot reach the surface after hatching. Tillage of stubble ground in the fall just before the egg-laying period has been found helpful also, as grasshoppers do not like a freshly tilled soil as a place for

depositing their eggs. Where crop residues are needed on the surface to prevent erosion, the duckfoot, one-way, or a subsurface blade or shovel tillage implement should be used. When initial tillage of the strips to be fallowed is started after hoppers have hatched, working from the outside toward the middle will concentrate hoppers in the center of the strip, where they may be poisoned with a minimum of cost.

More Birds in Strip-Cropped Fields

In the eastern United States it has been found that strip-cropped fields have larger breeding populations of ground-nesting birds than comparable fields not strip-cropped. Thus, strip cropping may assist in the destruction of insects by increasing the population of insect-eating birds.

Arrange Strips for Rotating Crops

Crops may be arranged in fields so that the meadow crops can be grazed one or more years of the rotation. Fields not strip-cropped may be combined with stripped fields in making the rotation balance. The following diagrams illustrate crop and field arrangements for three different rotations:

FIELD No. 1

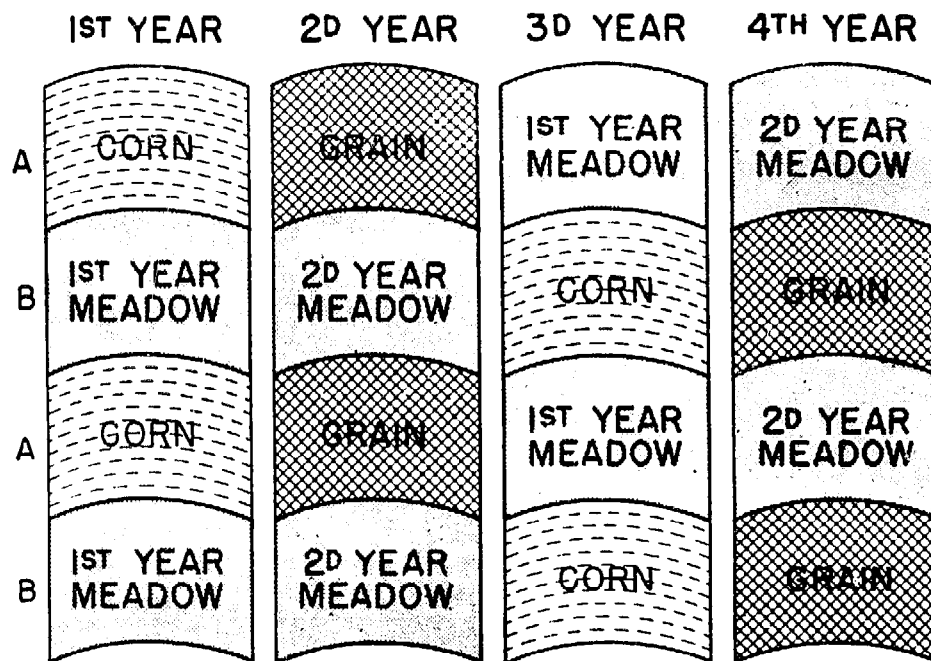

FIELD No. 2

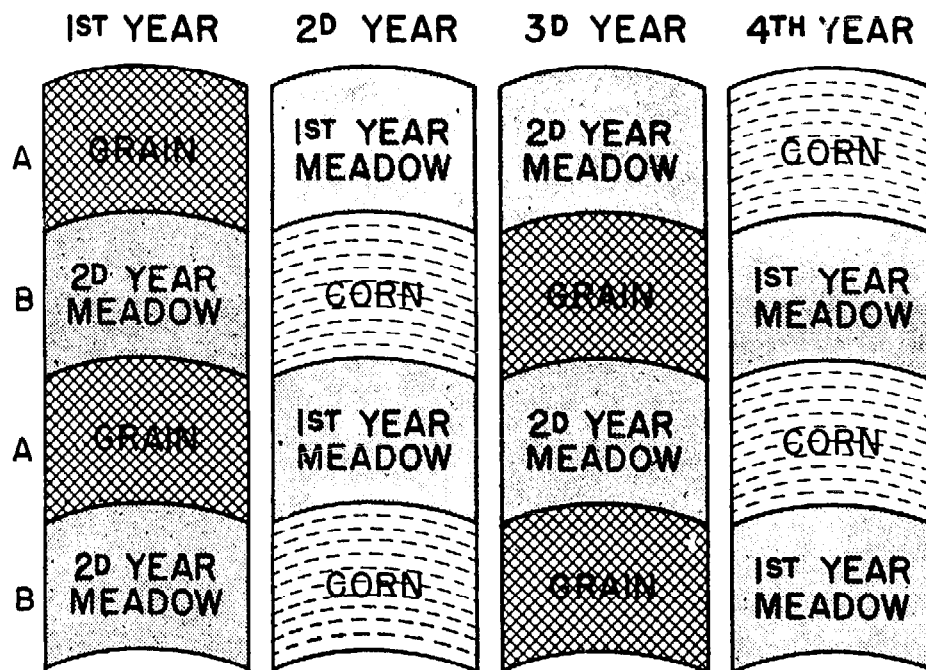

(From U.S.D.A. Farmers' Bulletin No. 1981)

Fig. 8-9. Diagram showing how two fields of strips can be worked together in a four-year rotation of corn, grain, meadow, meadow. Each year alternate strips are in corn and meadow in one field and grain and meadow in the other.

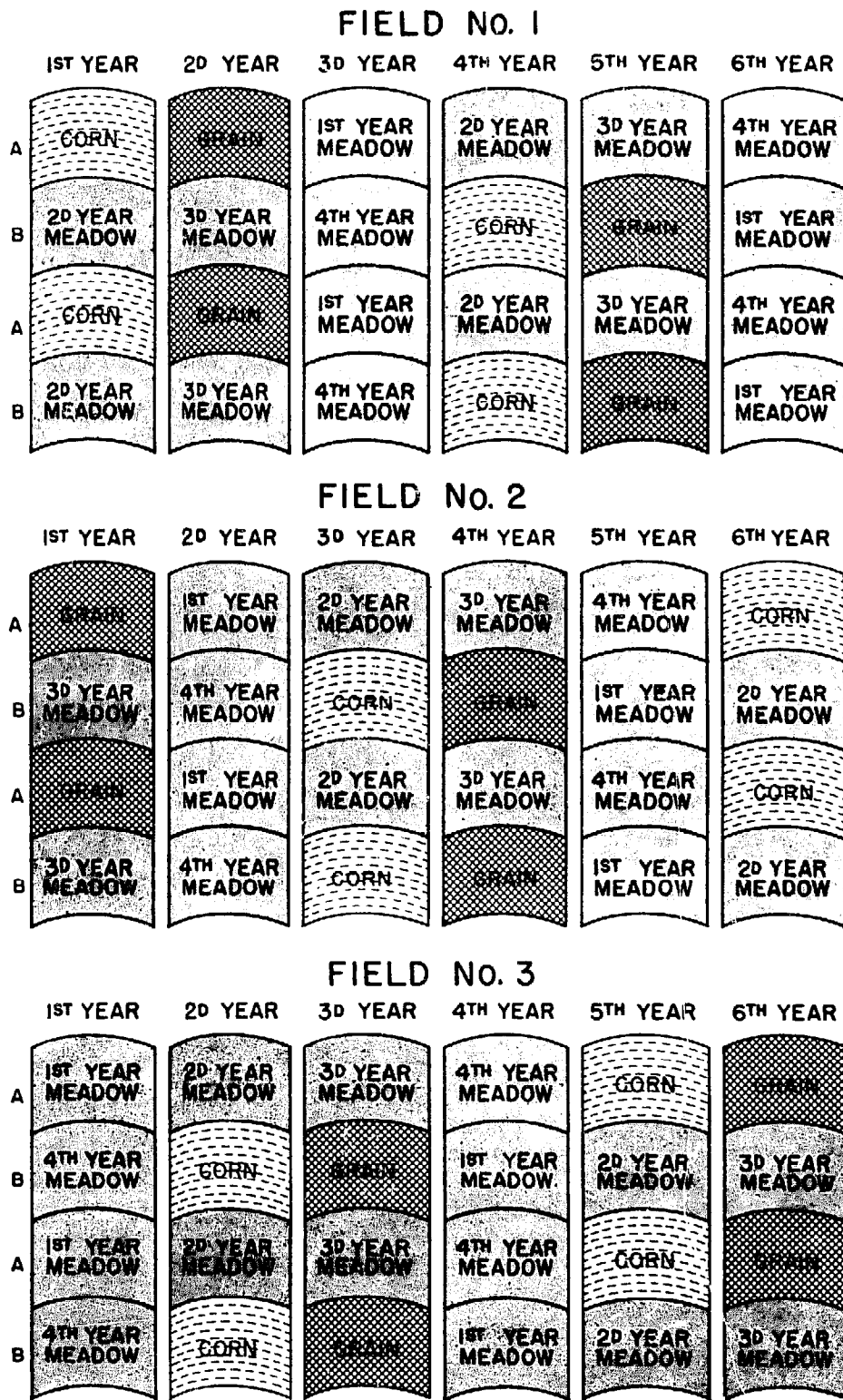

(From U.S.D.A. Farmers' Bulletin No. 1981)

Fig. 8-10. Diagram showing how three fields of strips can be worked together in a 6-year rotation. Each year alternate strips are in corn and second-year meadow in one field, grain and third-year meadow in a second field, and first- and fourth-year meadow in the other field.

FIRST YEAR

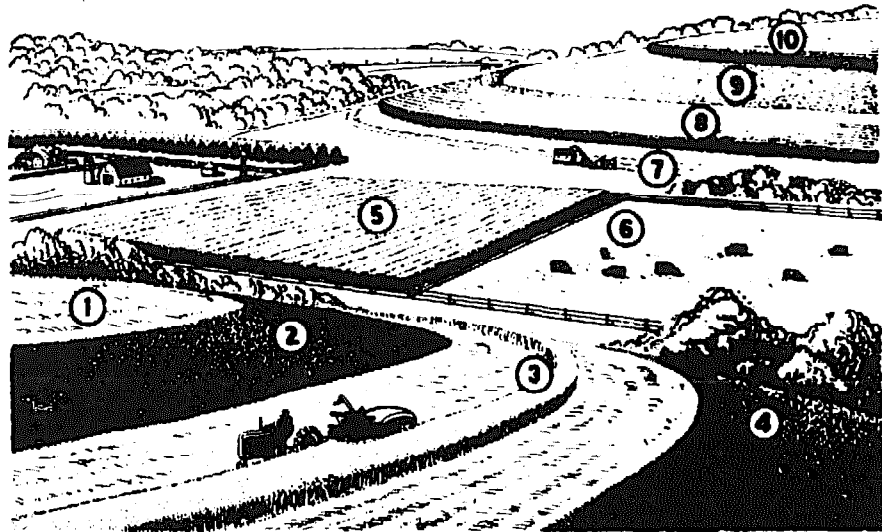

- | | | |
|-------------------|-------------------|-------------------|
| 1. SMALL GRAIN | 5. CORN | 9. 1ST YR. MEADOW |
| 2. 2ND YR. MEADOW | 6. 1ST YR. MEADOW | 10. CORN |
| 3. SMALL GRAIN | 7. 1ST YR. MEADOW | |
| 4. 2ND YR. MEADOW | 8. CORN | |

SECOND YEAR

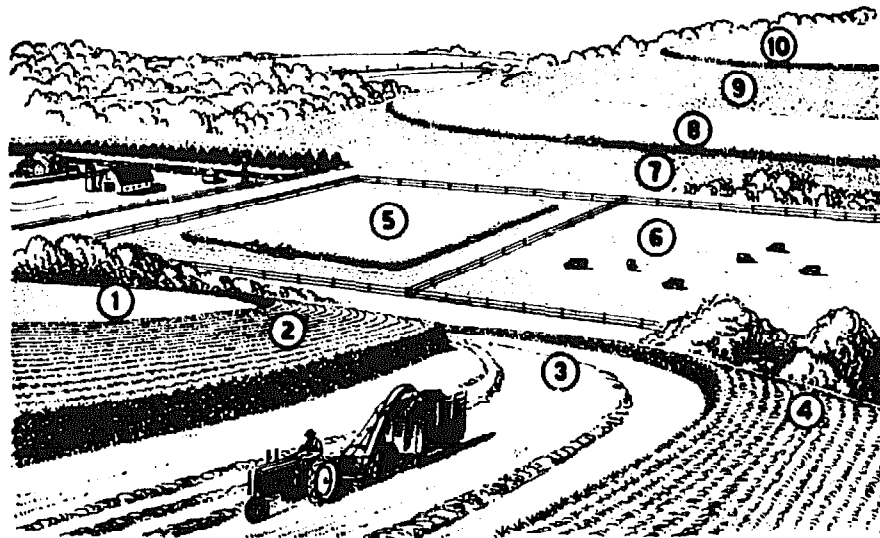

- | | | |
|-------------------|-------------------|-------------------|
| 1. 1ST YR. MEADOW | 5. SMALL GRAIN | 9. 2ND YR. MEADOW |
| 2. CORN | 6. 2ND YR. MEADOW | 10. SMALL GRAIN |
| 3. 1ST YR. MEADOW | 7. 2ND YR. MEADOW | |
| 4. CORN | 8. SMALL GRAIN | |

(Drawing: U. S. Soil Conservation Service)

Fig. 8-11. The four drawings shown here and on the following page demonstrate how the strips in two strip-cropped fields can be combined with two fields not strip-cropped to balance out a four-year rotation of corn, grain and two years of meadow.

THIRD YEAR

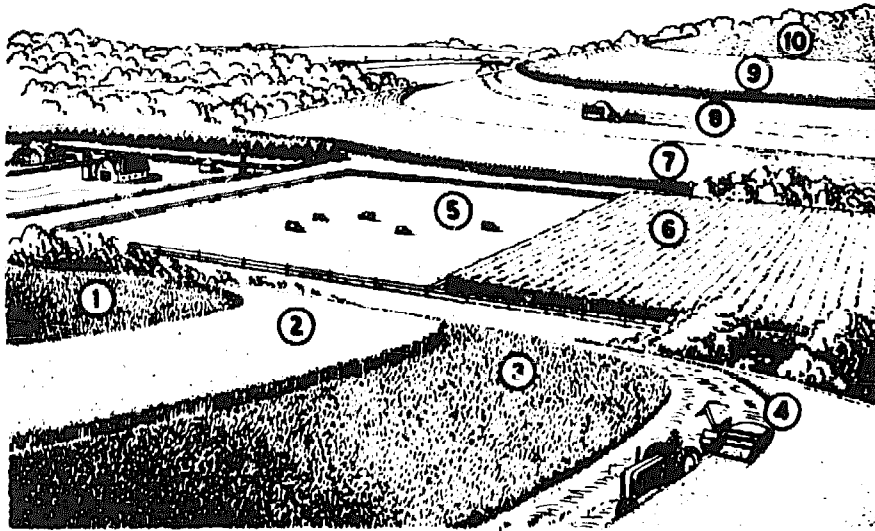

- | | | |
|-------------------|-------------------|--------------------|
| 1. 2ND YR. MEADOW | 5. 1ST YR. MEADOW | 9. CORN |
| 2. SMALL GRAIN | 6. CORN | 10. 1ST YR. MEADOW |
| 3. 2ND YR. MEADOW | 7. CORN | |
| 4. SMALL GRAIN | 8. 1ST YR. MEADOW | |

FOURTH YEAR

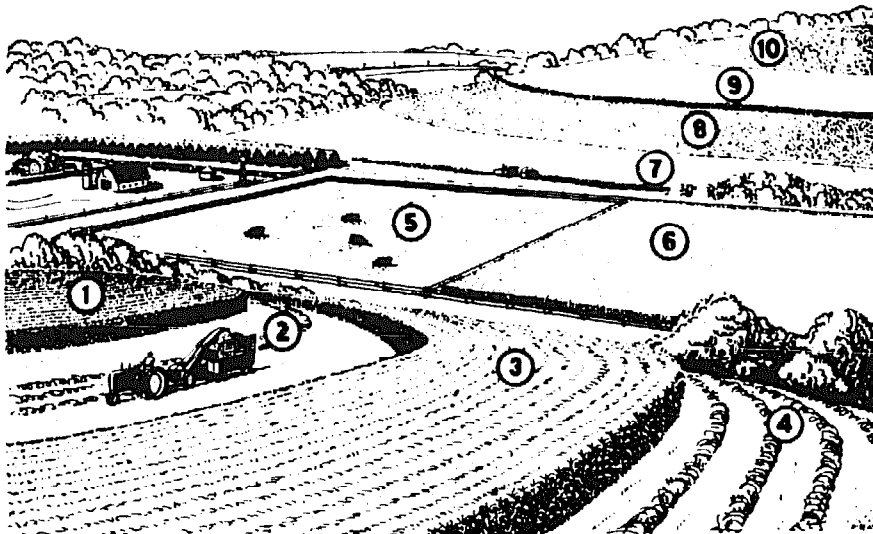

- | | | |
|-------------------|-------------------|--------------------|
| 1. CORN | 5. 2ND YR. MEADOW | 9. SMALL GRAIN |
| 2. 1ST YR. MEADOW | 6. SMALL GRAIN | 10. 2ND YR. MEADOW |
| 3. CORN | 7. SMALL GRAIN | |
| 4. 1ST YR. MEADOW | 8. 2ND YR. MEADOW | |

Fig. 8-11 (Continued)

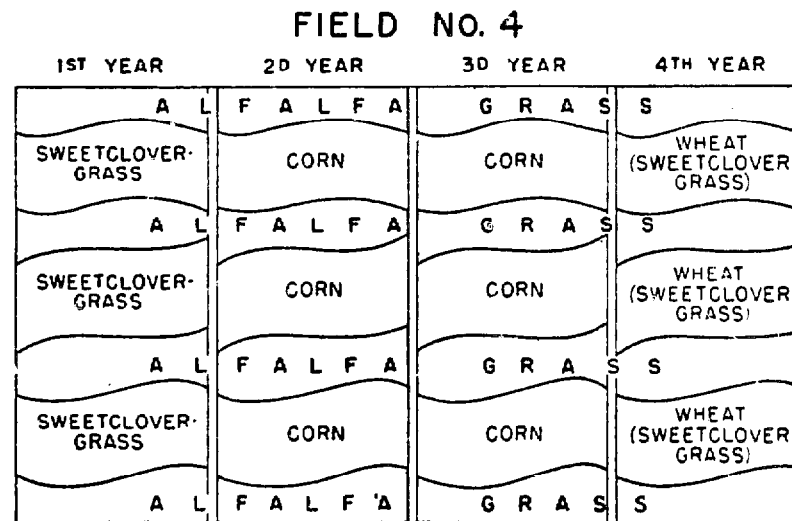
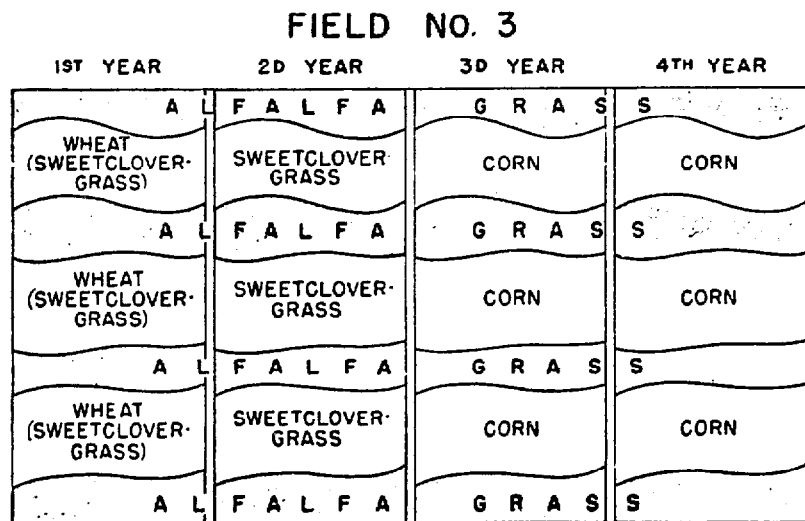
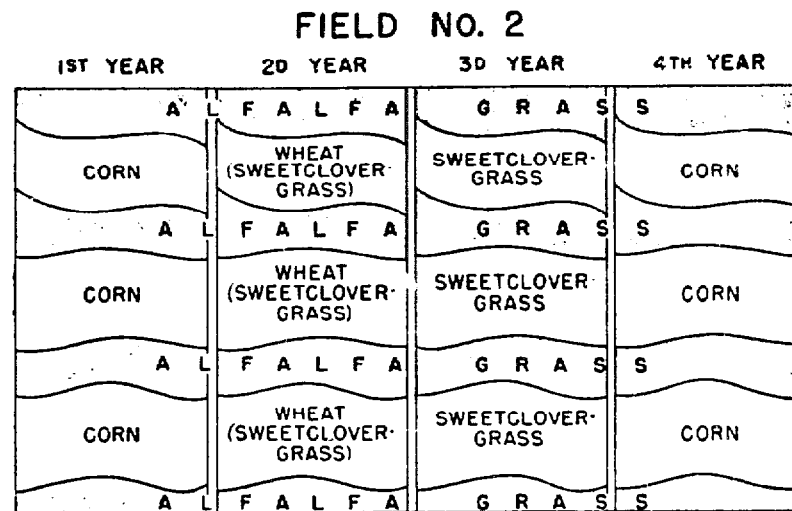
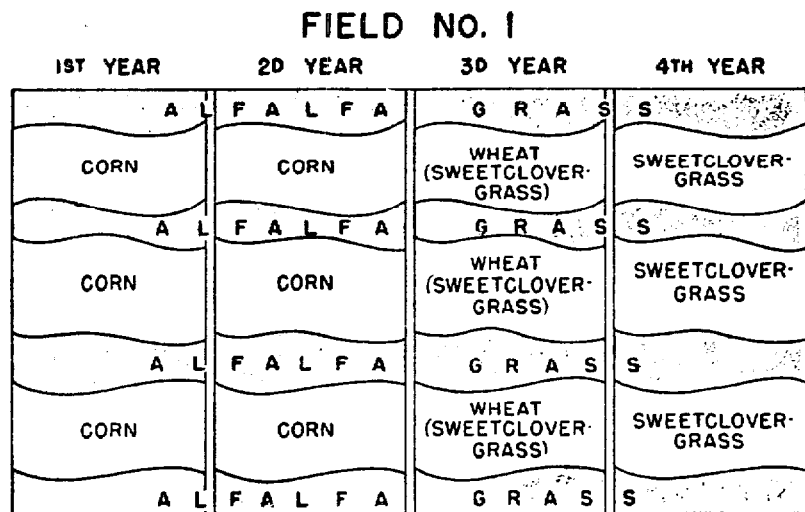

(From U.S.D.A. Farmers' Bulletin 1981)

Fig. 8-12. These drawings show the arrangement of fields in a buffer strip cropping system where a four-year rotation of corn, corn, grain and sweet clover is followed. The buffer strips remain continuously in alfalfa-grass. Each year two fields are in corn, one in grain and one in sweetclover.



(Photo: U. S. Soil Conservation Service)

Fig. 9-1. Planting corn on a terrace with an 8-row planter.

terraced area. Terraces control erosion even during these critical intense storms by reducing the length of the slope.

Terraces give the farmer more possibilities in planning his cropping system. With terraces the entire field can be farmed to a single crop. The cropping system can be more intensive, that is, there can be fewer years of hay as compared to grain and row crops. However, terraces cannot take the place of a good cropping system. Grass and legumes are needed to keep up good soil tilth.

Terraces must be built right and maintained if they are to be successful. If they are drainage type, outlets are needed. And terraced land must be farmed with the terraces. These difficulties can be overcome and terraces can be, and are, one of the most important supporting conservation practices on cropland.

Diversions are large terraces usually designed to handle water from a larger area than is expected of a

regular terrace. Each diversion is tailored to fit the particular situation.

A Suggested List of Activities Involving Approved Practices

1. Planning the Terrace System
2. Locating and Staking Terrace Lines
3. Constructing Terraces
4. Terracing with a Grader
5. Building Terraces with Plows
6. Using the Two-Way Plow
7. Using the Whirlwind Terracer
8. Using the Bulldozer
9. Using Motor Patrol Type Grader
10. Checking, Finishing Terraces
11. Maintaining Terraces
12. Farming Terraced Land
13. Using Other Tillage Implements
14. Planting Row Crops
15. Harvesting Crops on Terraced Land
16. Parallel Terraces
17. Using Diversions

1. Planning the Terrace System

Study the Field

Terraces will be on the field a long time and will be farmed over many times, so they should be planned with ease of farming as well as other design factors in mind. A little extra work at the time the terraces are constructed may save some time each time the field is farmed. This is good planning.

Look over the field and study the soil. Then decide what kind of outlets you need and where they should be. Probably on most fields grass waterways will be best for outlets. But on some fields you may decide that

an underground outlet, commonly known as a tile outlet, is best. The soil may be permeable enough that the terraces can be built level with closed ends so that the outlet is the soil itself.

Is water from the neighbor's land going to be a problem? Consider the length and shape of the slope, the location of roads in the field, and check whether terraces can be made parallel. Is the slope gentle enough that the terraces can be broad and crossed with large equipment, or is it steep enough that you will want to consider grass backslope terraces?

The steps outlined here are based on the assumption that the terraces will need to drain to some sort of surface outlet. Parallel terraces and grass backslope terraces and underground outlets are discussed later in the chapter.

Location of the Outlets

One of the most important things to consider in a terracing job is the location of the proper outlets. Well sodded permanent pastures and draws or unpastured woodlots that have a thin stand of trees and a tough sod make good natural outlets.

If a natural outlet does not already exist outlets will need to be prepared. These should probably be located in the natural drainageways on the farm. Outlets generally should be prepared a year or two ahead of the construction of the terraces.

In the northern half of the country terrace outlets should be placed, where feasible, on south or west slopes to facilitate drainage of the terraces during the spring thaw period. South and west facing slopes thaw first in the spring and outlets on these slopes will be free of snow or ice when the major part of the thaw runoff occurs. Outlets should not be located near obstructions that may cause heavy drifting of snow.

If natural waterways cannot be used, it will be necessary to construct a channel. Locate it where it will be most convenient and will cause the least problem in using the field.

Consider Adjoining Fields

If water from a neighbor's field runs into the field to be terraced, arrangements must be made to handle this water. Each terrace can handle only so much water, and where water from a neighbor's field must be handled it may be necessary to construct a larger diversion-type terrace at the top of the field.

An adjoining field on the same farm may use the same outlet. In considering the overall farm plan, fences may be moved to make a more efficient arrangement.

Analyze the Slopes

Fields with uniform slopes that do not have abrupt changes in slope or deep gullies are usually easiest to terrace. Terraces on uneven slopes form queer, irregular patterns that are difficult to farm. These problems will be taken up in the preparation of the conservation plan for the farm, and fields such as this will be planned for a use that will not require terracing. But the final plan for the field will need to be based partly on its adaptability to the use of terraces.

Estimate the Length of Terraces

A preliminary study of the field will help to estimate the length of the terraces. Present practice calls for using all or most of the natural waterways in a field. This generally limits the length of a terrace draining one way to 300 to 400 feet. In any event, they should not be long—never over 1,600 to 1,800 feet. If it

appears that they will be longer than this, additional outlets will be needed in the middle of the field or at each side of the field.

Plan for Farm Roads

Roads into and out of terraced fields must be planned to conform to the terrace system. A road placed at the end of terraces should be at the upper end of the terraces, not at the outlet end. Where terraces flow opposite directions to natural waterways, they can be left "open" on the ridge, leaving a place for a roadway. If a road must be located at the outlet it should parallel the outlet on the outside so that the terraces need not be crossed. The waterway should not be used for a roadway. Where possible, locate the road on the contour just below a terrace or on the ridge where the terraces are crested.

2. Locating and Staking Terrace Lines

Assemble Equipment Needed

Some type of level is needed to lay out terraces; either a farm or builder's level is satisfactory for this purpose. A rod marked in feet and inches or in feet and tenths of a foot may be used. Enough stakes to allow one to be used every 50 feet along the terrace line should be provided. Where the terrace line crosses a ridge or depression or makes a sharp turn, the stakes should be set closer. A notebook and pencil are needed for figuring slopes and spacings, and to make a record of the layout.

Determine Distances Between Terraces

One of the first steps in terrace layout is the determination of the vertical interval between terraces.

Many factors such as the slope of the land, amount and intensity of rainfall, soil characteristics, length of season, and others are involved in determining the spacing between terraces. In the Northern States, where the ground is not subject to erosion during the several months of the year when it is frozen, terrace intervals may be slightly greater than is permissible in the Southern States. Rainfall intensities are also generally lower in the Northern States.

A good rule for the spacing of terraces found to apply in the Upper Mississippi Valley States is to determine the slope of the land and apply this formula: per cent of slope

$\frac{\text{per cent of slope}}{2} + 2$. The figure that this equation gives is the vertical interval between terraces. For example, if the slope is 6 per cent, 6 divided by two plus 2 gives a vertical spacing of five feet. Table 9-1 gives vertical interval, horizontal interval, feet of terrace per acre of land terraced, and acres terraced per 1,000 feet of terrace. This table is helpful in figuring costs of terraces as well as in figuring specifications.

TABLE 9-1. Spacing formula for Upper Mississippi Valley States.

$$\text{SPACING FORMULA} = \left(\frac{S}{2} + 2\right)$$

Field Slope %	1	2	3	4	5	6	7	8	9	10	11	12	13	14	15
Vertical Interval	2.5	3.0	3.5	4.0	4.5	5.0	5.5	6.0	6.5	7.0	7.5	8.0	8.5	9.0	9.5
Horizontal Interval	250	150	117	100	90	83	79	75	72	70	68	67	66	64	63
Feet per Acre	174	291	373	436	485	525	552	581	605	623	642	650	660	682	692
Acre per 1000 ft.	574	345	268	230	206	191	182	172	165	161	156	154	152	147	145

In areas where there is more rainfall, and where the ground is not frozen as much and therefore subject to erosion for longer periods, terrace spacings should be closer. Note in Table 9-2 from Tennessee Extension Publication 339 that under average conditions, on a 6 per cent slope the vertical interval should be 4 feet as compared to 5 feet for the Upper Mississippi Valley

TABLE 9-2. Terrace spacing recommendations.

% Slope	Standard Table Average Conditions		Table for Highly Erodible Soils (Generally loess soils of W. Tenn.)		Table for Less Erodible Soils (Generally limestone regions)	
	Vertical Interval	Horizontal Spacing	Vertical Interval	Horizontal Spacing	Vertical Interval	Horizontal Spacing
1	-----	-----	1' 0"	100'	-----	-----
2	2' 6"	125'	2' 0"	100'	-----	-----
3	3' 0"	100'	2' 6"	83'	3' 4"	110'
4	3' 4"	85'	3' 0"	75'	3' 8"	92'
5	3' 8"	75'	3' 6"	70'	4' 0"	80'
6	4' 0"	66'	Use Standard Table Spacings up to 10% Slopes		4' 4"	70'
7	4' 3"	62'			4' 8"	66'
8	4' 6"	58'			5' 0"	62'
9	4' 9"	54'			5' 3"	58'
10	5' 0"	50'			5' 6"	56'
11	-----	-----			5' 9"	52'
12	-----	-----	-----	-----	6' 0"	50'

(From Tennessee Ext. Pub. 339)

The purpose of the above tables is to serve as a guide based on experience and experiments. Spacings may be increased or decreased up to 10% when and to the extent that circumstances of a particular situation may warrant.

States. Check with local technicians for the spacing recommended for your area.

Determine the average slope by setting up a surveying instrument above the terrace to be staked, pace off a hundred feet parallel to the slope of the land, and read the difference in elevation at the two points. Several readings will be needed to get the average slope. (Fig. 3-8 from Chapter III.)

Stake the First Terrace

The upper terrace is generally staked first, the drainage divide being used as a starting point from which to measure the vertical interval for the first terrace. The top terrace should always have adequate capacity to handle the volume of water draining into it and its location may be varied with this in mind. Usually the top terrace should be located one interval below the top of the slope. Some general rules for locating the top terrace are:

1. If the top of the hill comes to a point, the interval

may be increased to one and one-half times the regular terrace interval.

2. On long ridges, where the terrace approximately parallels the ridge, the regular interval should be used.

3. The drainage area of the top terrace shall not exceed three acres.

After the vertical interval has been determined for graded terraces, start at the outlet and stake the line. The first 50-foot stake should be 0.7 to 0.8 foot higher than the terrace outlet, depending on the channel grade selected. This is to allow for the cut made in constructing the terrace channel.

Grade in Terrace

Set stakes every 50 feet. Provide a uniform grade in the terrace ranging from .3 to .5 foot per 100 feet of terrace length. This can be done by reading a slightly lower point on the rod at each reading. For example, if the grade selected is .4 foot, read a point on the rod, or lower the target if target is used, .2 foot at each 50-foot station. This will give the gradual rise in the terrace line that you want.

Vary the grades within the above limits to provide alignment of terraces as nearly parallel as the topography will permit.

The last stake at the upper end of each terrace should be set up the slope 0.4 foot from its normal position. If this is not done, some scraper work will be needed to close the upper end of the terrace.

Stake the Other Terraces

To locate the outlet stake of the second terrace down the slope, set up the level as before, 200 to 400 feet from the outlet and somewhat below the first terrace line. Then take a rod reading at the outlet stake of the

top terrace and add to that the vertical interval spacing, which is determined by the average slope in the area to be protected by the second terrace. Proceed as in the first staked line.

Measure the slope at several points before laying out succeeding terraces. These measurements can be taken by the rodman and instrument man as they return to the outlet to start the next terrace. This gives the instrument man the necessary information for staking out the next terrace when he reaches the outlet.

After the line has been staked it is well to check and arbitrarily move some stakes if necessary to ease sharp turns. Ordinarily, such adjustments should be limited so that no more than six inches of cut or fill will be made. With a little experience, stakes can be moved up or down the slope to compensate for the equipment "creeping" while going around sharp turns. When a terrace is to be constructed across a draw or gully, set the stakes to form a smooth curve bending up the slope at the gully. (Fig. 9-2.)

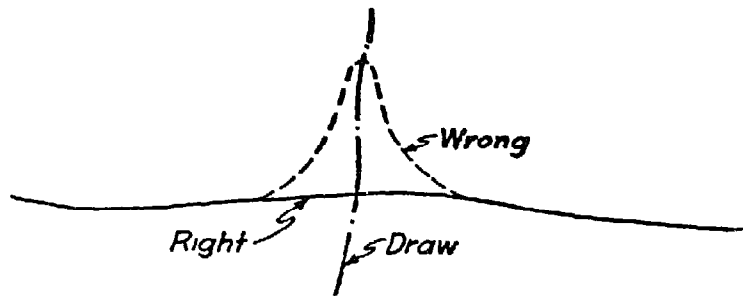

(Drawing: U. S. Soil Conservation Service)

Fig. 9-2. Straighten sharp curves at draws.

3. Constructing Terraces

Construction of terraces consists of moving earth in such a way as to make a channel and a ridge that can be crossed with regular farm machinery. More channel capacity can be obtained for the amount of earth



Ridge type terrace. The height of the ridge above the normal ground line, "h," should be 12" to 16½", depending on the land slope. The greater the slope, the greater "h" should be.

The cross sectional area of the ridge above the normal ground line, "A" should be 8½ to 12½ square feet.



Channel type terrace. The water channel "A" should be 10 to 16 square feet in cross section, for terraces draining less than 1500 feet in one direction. For longer terraces the cross section should be greater. The greater section given above is for terraces on land with a slight slope, while the lesser section is for land with greater slope.

(From Texas Ext. Bulletin B-51)

Fig. 9-3. Ridge and channel type terraces.

moved if the earth is all moved from the upper side as compared to building from both sides. (Fig. 9-3.)

Satisfactory terraces can be built from both sides, however. The method to be used is determined by the equipment available, and by the slope and the nature of the soil. On the more gentle slopes, for example, where terraces are built with wider cross sections, some earth may be moved from the lower side. On slopes over 5 or 6 per cent the one-side method is preferred. In building most of the terrace from one side, a reversible machine is more efficient because all the excavated material is moved downhill. In using the conventional plow or any implement that is not reversible, a system is ordinarily used whereby the ridge is worked in one operation and the channel in another. In this way almost 75 per cent of the excavation is made from the upper side.

Construction Procedure

The upper terrace should be constructed first and after it, in turn, each succeeding terrace down the slope. The top terrace not only should be built first

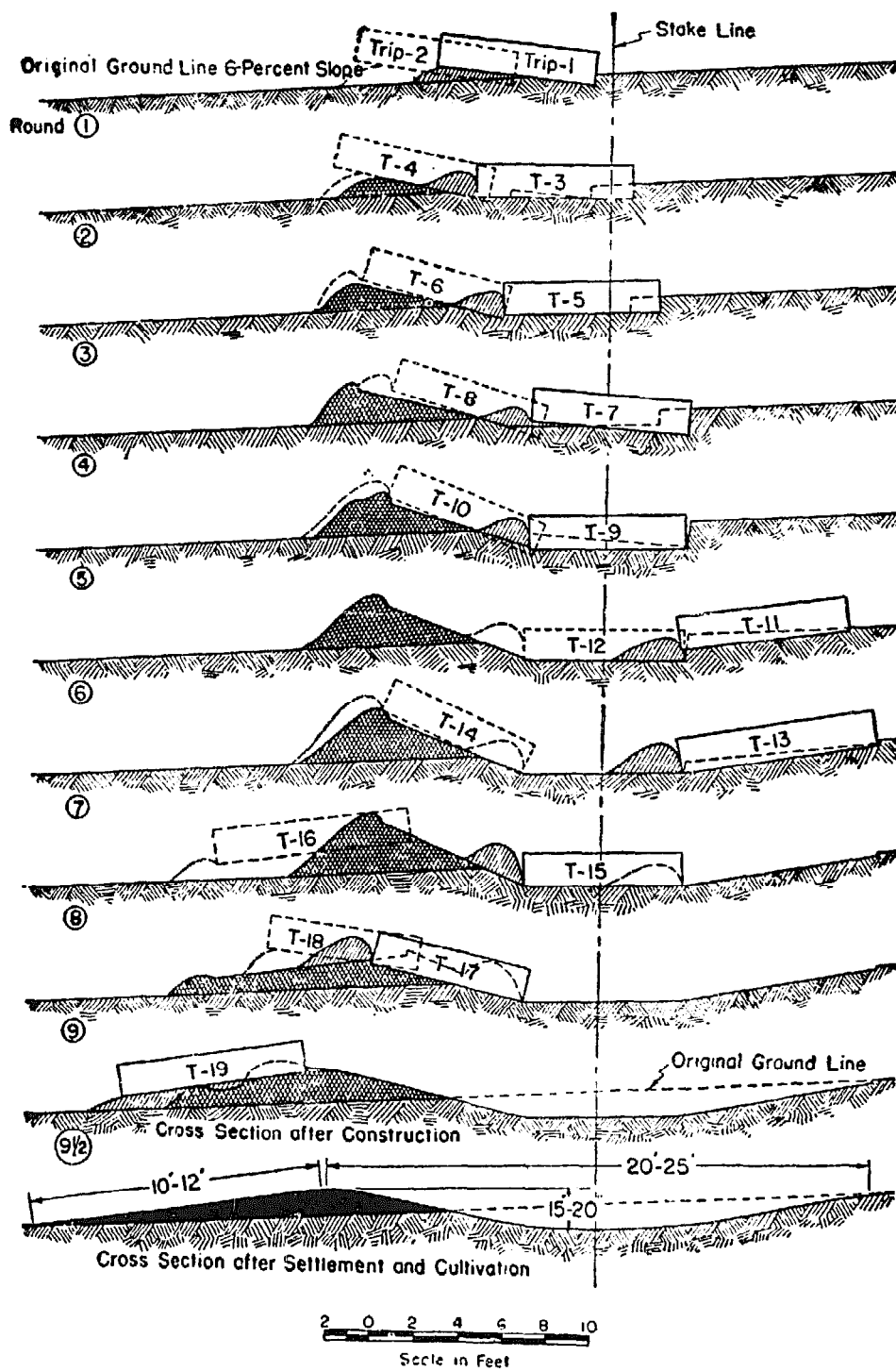

(From U.S.D.A. Farmers' Bulletin 1789)

Fig. 9-4. Progressive steps in constructing a channel terrace.

but must be well constructed because the safety of the lower terraces depends upon it. If the top terrace fails, the other terraces will likely fail because of the overload they will receive.

All deadfurrows or ditches to be crossed with the terrace should be filled before the construction begins. All old fence rows should be leveled off. Surplus vegetation should be removed if terraces are to be constructed with a plow or a whirlwind terracer. Heavy sod should be thoroughly disked.

4. Terracing with a Grader

Progressive steps in constructing terraces with a 10-foot blade terracer are shown in Fig. 9-4. The blade should be set so that the first cut is made just off the stake line. On the return trip the blade is reversed to push the disturbed material further toward the proposed ridge. Succeeding cuts should be made so that the stake line will be at the center of the terrace channel.

5. Building Terraces with Plows

Terraces can be built with ordinary moldboard plows. The island method with the moldboard plow is widely used. It requires about 32 to 36 rounds to construct a standard terrace. Figure 9-5 shows in detail the sequence of rounds.

Plow the first furrow 5 feet and the return furrow 15 feet downhill from the channel stake line. These two furrows can be located by staking or by two men walking with a rod held between them. One man walks the channel stakes, the other walks ahead of the plow.

Start Out Shallow

Start out by plowing the first series of five rounds

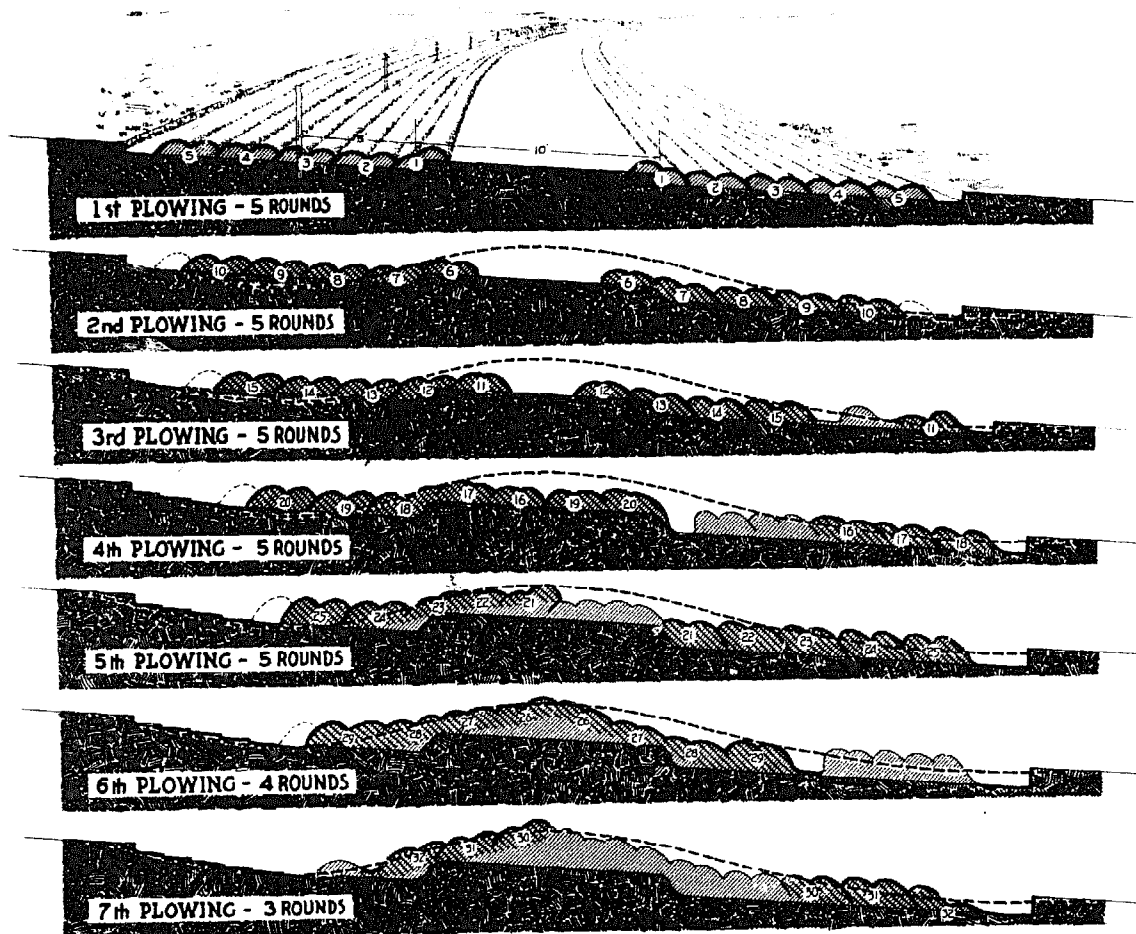

(From U.S.D.A. Handbook No. 135)

Fig. 9-5. The island method of building terraces with a moldboard plow, working from both sides.

shallow. Then plow the next series about one inch deeper so as to reach undisturbed soil. If the soil is "powder dry" or too wet, it is advisable to delay construction until a favorable moisture condition exists. Remove jointers and coulters and have the shares sharp. Maintain enough speed to keep the plow throwing soil and so the furrows will leave the moldboard. Keep the plow as level as possible.

Experience has shown that after the fifth series of rounds, or after 20 to 25 rounds, some deviations may be desirable due to the condition of the soil, how the plow operates, and the "human" equation of the oper-

ator. If the terrace ridge is not the height shown in Table 9-3, additional plowing may be necessary.

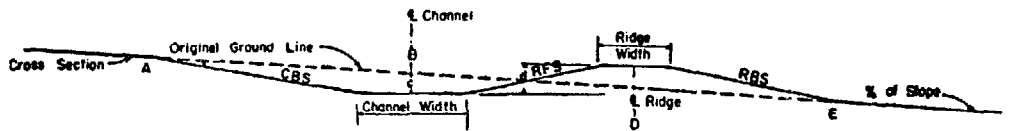

GRADED TERRACE CHANNEL DIMENSIONS									
Length Ft Field Slope	Needed Terrace Ridge Height in Feet					Approximate Slope Ratio			
	200	400	600	800	1000	CBS	RFS	RBS	S
1	0.8	0.9	1.0	1.2	1.2	10:1	10:1	10:1	
2	0.8	0.9	1.0	1.2	1.2	10:1	10:1	10:1	
3	0.7	0.9	1.0	1.1	1.2	6:1	8:1	8:1	
4	0.7	0.9	1.0	1.1	1.1	6:1	8:1	8:1	
5	0.7	0.9	1.0	1.1	1.1	6:1	8:1	8:1	
6	0.7	0.8	0.9	1.0	1.0	6:1	8:1	8:1	
7	0.7	0.8	0.9	1.0	1.0	4:1	6:1	6:1	
8	0.7	0.8	0.9	1.0	1.0	4:1	6:1	6:1	
9	0.7	0.8	0.9	1.0	1.0	4:1	6:1	6:1	
10	0.6	0.8	0.9	1.0	1.0	4:1	6:1	6:1	
11	0.6	0.8	0.9	1.0	1.0	4:1	4:1	5:1	
12	0.6	0.8	0.9	1.0	1.0	4:1	4:1	4:1	
13	0.6	0.8	0.9	1.0	1.0	4:1	4:1	4:1	
14	0.6	0.8	0.9	1.0	1.0	4:1	4:1	3:1	
15	0.6	0.7	0.9	1.0	1.0	4:1	4:1	2 1/2:1	

NOTE: Above figures are settled ridge height and are based on 10yr runoff and a channel with 6' bottom, 0.4 percent grade. The same height should be used for 0.6 percent grade. The height should be increased 0.1' for a grade of 0.2 percent. A top width of at least 2' should be provided

LEGEND
 CBS - Channel back slope
 RFS - Ridge fore slope
 RBS - Ridge back slope
 S - Slope of land

TABLE 9-3. Graded terrace channel dimensions. (For Upper Mississippi Valley Region.)

(From U.S.D.A. Handbook No. 135)

6. Using the Two-Way Plow

With the two-way plow—a plow that has two sets of moldboards and permits throwing the soil either way—all the soil is moved from the upper side. (Fig. 9-6.) This type of terrace can also be built with the conventional plow by returning empty each round; or if the field is to be plowed, this can be done on return trips. Figure 9-7 shows in detail the sequence of rounds.

A second set of stakes should be set 11 feet below the channel stakes. This row marks the first plowing. Start the first plowing by throwing the furrow slice against the lower stake line and plow 8 throughs. Start each successive plowing with the front bottom picking up the third furrow slice (marked with arrow) of the

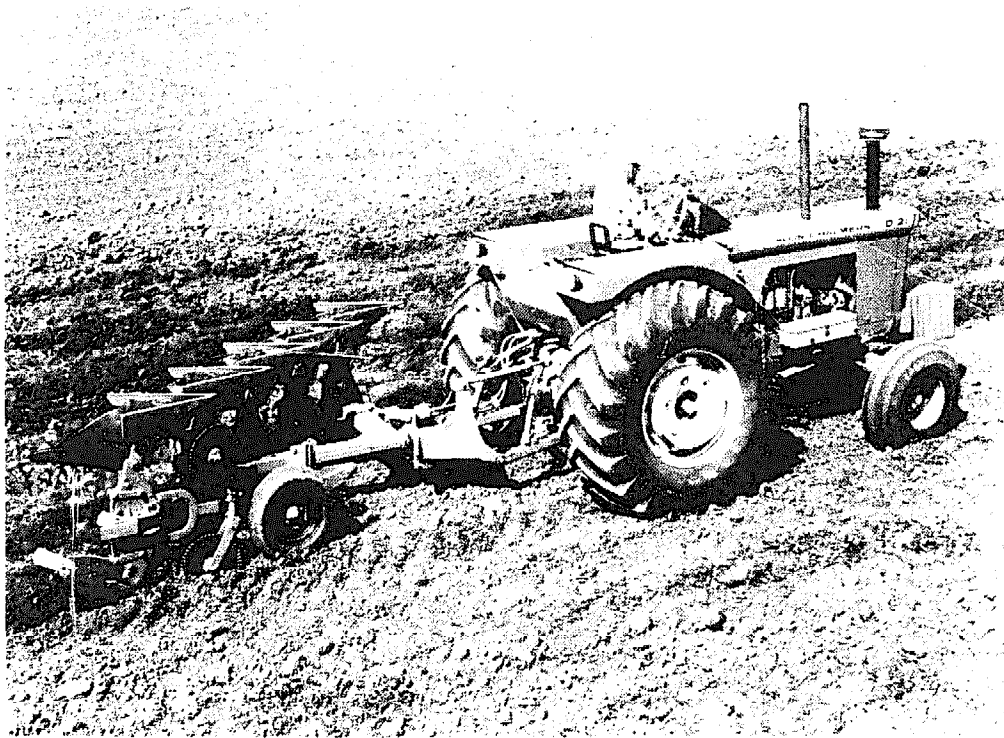

(Photo: Allis-Chalmers Mfg. Co.)

Fig. 9-6. A two-way plow has two sets of moldboards, making it possible to throw all furrows downhill.

previous plowing. Crowd over if necessary so as to form a smooth backslope.

7. Using the Whirlwind Terracer

The whirlwind terracer is an efficient piece of equipment for terrace construction. It will not work satisfactorily in rocky or stony soil; neither will it work well in heavy sod.

Remove Vegetation First

All heavy vegetation should be removed. Heavy sod should be thoroughly disked before starting the construction or after the first series of rounds. To operate a whirlwind satisfactorily, a tractor that can handle a three- or four-bottom plow is required. The plow should

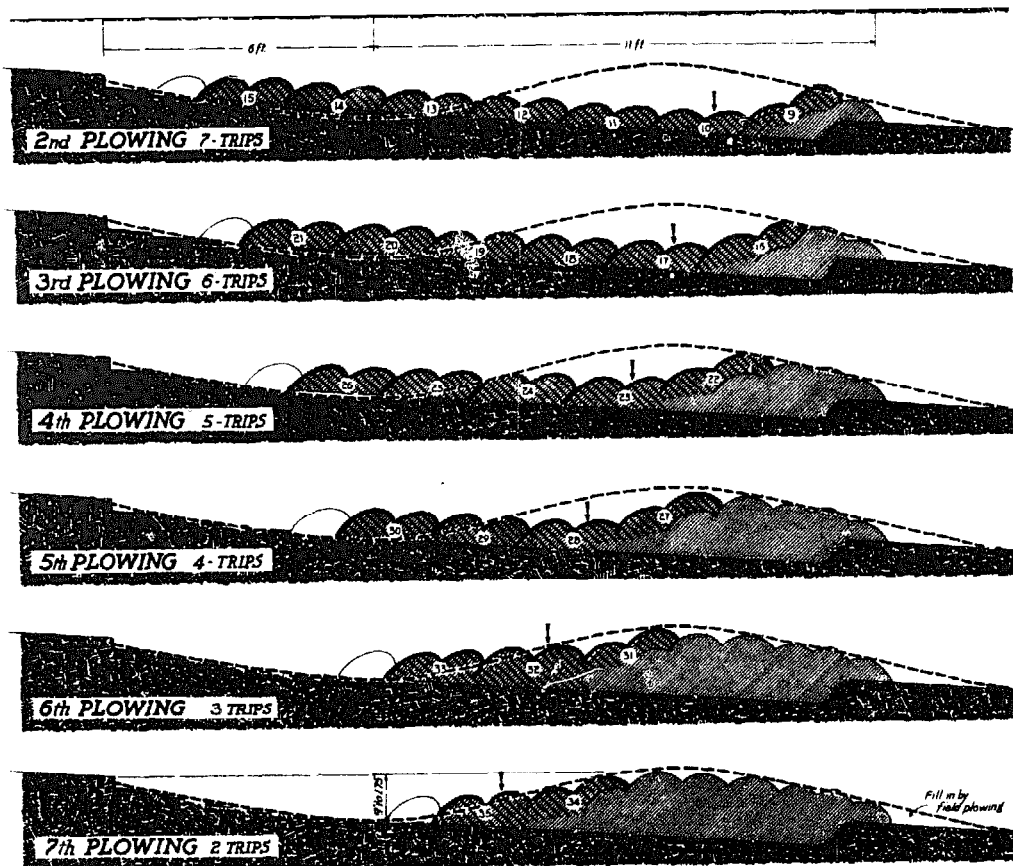

(From U.S.D.A. Handbook No. 135)

Fig. 9-7. Plowing sequence for building terraces, using the two-way plow.

not cut deeper than the tractor can pull without reducing the motor speed. This will maintain the speed of the rotor necessary to throw the soil up on the ridge. The terracer should be kept level so that the rotor can effectively throw the soil.

It generally requires 25 to 30 rounds to complete a terrace, depending on the condition of the soil and the size of tractor used.

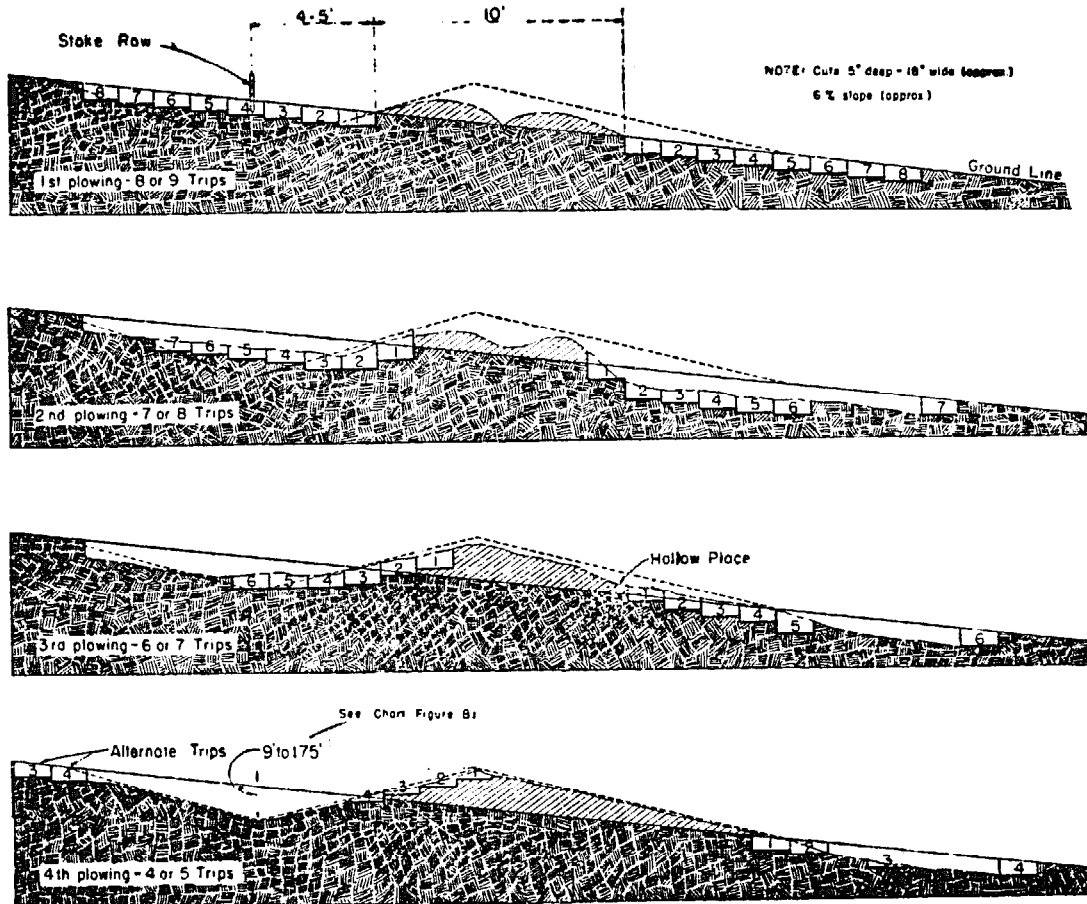

(From U.S D.A. Handbook No. 135)

Fig. 9-8. Plan for constructing terraces with the whirlwind terracer.

A 10- or 12-foot island is recommended on the average fields. (Fig. 9-8.) Here again local customs are different and some operators start by throwing the soil together the first round. The method illustrated, therefore, is merely a guide.

8. Using the Bulldozer

While bulldozers are not commonly used in constructing terraces, in certain localities they have been used successfully. The bulldozer has an advantage in many respects. It can be used on very rough and eroded soils. The ditches can be filled as part of the

terrace construction operation. The bulldozer will operate under conditions in which other types of equipment cannot efficiently function, such as in extremely dried out soils. Two methods have been used. (Fig. 9-9.)

The roughing-in is accomplished by making three "cuts" and "bucks." (The method shown as staggered cut method, however, puts a strain on the steering

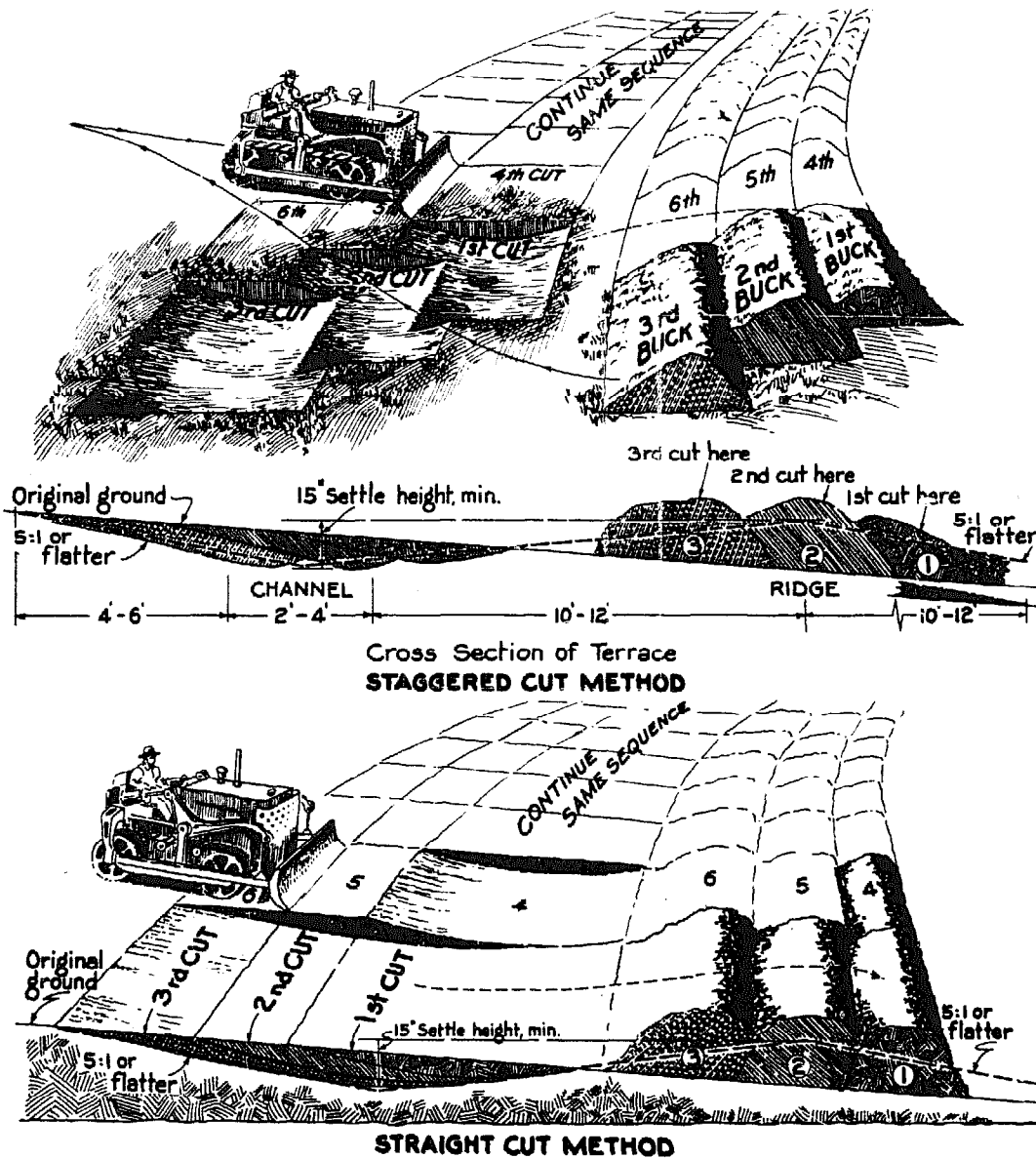

(From U.S.D.A. Handbook No. 185)

Fig. 9-9. Two methods of building terraces with the bulldozer.

clutches.) After the roughing-in is completed, two rounds are made lengthwise on the ridge, and sometimes one in the channel is necessary to give the terrace its final shape and cross section.

9. Using Motor Patrol Type Grader

For heavy work this type of equipment does an excellent job. Where a contractor has enough work for a machine of this type, it is very effective and very efficient. A skilled operator can cut a channel true to grade and very little follow-up will be required to remove high and low spots in the channel. See Fig. 9-4 for suggested sequence of trips.

Time Required

Table 9-4 gives the average time requirements for constructing terraces by various methods. It should be

TABLE 9-4. Time requirements for terracing.

Type of Equipment	Feet Per Hour	Hours Per Mile
Moldboard plow - 2 bottom	125 - 190	28 - 41
Disk tiller	170 - 190	28 - 31
Whirlwind	170 - 200	26 - 31
Motor patrol grader	180 - 220	24 - 29
Bulldozer	180 - 220	24 - 29
Elevating grader, small	180 - 220	24 - 29
Elevating grader, large	200 - 250	21 - 26

(From U.S.D.A. Handbook No. 135)

kept in mind that time required for making fills is included in time required with motor patrol grader and bulldozer and is not included in those built by other methods.

10. Checking, Finishing Terraces

After construction is completed the terraces should be checked with rod and level to locate high and low spots so that corrections can be made. Ponding should be prevented in terraces since it causes crop loss and is a hindrance to farming operations. Low places in terrace ridges should be corrected since they are the cause of terrace failure.

11. Maintaining the Terraces

Even though properly planned and constructed, terraces will not give the protection over a period of years unless they are kept in good repair. The terraces as well as other soil conservation structures should be considered the same as farm buildings and fences insofar as maintenance is concerned. Unless kept in good condition they will fail and may cause more harm than good.

Inspect After Heavy Rains

Careful inspection of terraces the first year after they are built is very important. Ridges and fills may settle the first year. After each heavy rain the terraces should be inspected and any breaks or low places immediately repaired before the damage becomes serious. The outlets should be watched so that prompt measures can be taken if washing starts.

Proper height of the terraces can be maintained by proper farming methods. All plowing should be done in such a manner that the backfurrows are made on top of the terrace ridge. If this is done each time the field is plowed, proper height is maintained by compensating for wearing down caused by the usual farming operations. Deadfurrows should be left in the terrace chan-

nel as often as possible. See the section on farming terraced land for suggestions on plowing terraced land.

12. Farming Terraced Land

Plowing

There are many ways of plowing terraced land. The easiest method as well as the method that will keep the terraces in good shape and the field in proper contour is with the two-way plow, a plow that has two sets of moldboards and permits throwing the soil either to the right or to the left. Unfortunately few of these plows are found on farms but they probably will become more common as farmers see their value.

Use Two-Way Plow

As shown by Fig. 9-10 the two-way plow makes it possible to keep the terraces properly shaped and avoids the benching effect that usually occurs after several plowings with the conventional plow. Furrows are all thrown uphill starting from the ridge of one terrace, moving down to the channel of the one below it. Furrows are thrown in a downhill direction only on the uphill side of the terrace.

Start plowing by throwing the first furrow up on the ridge of the upper terrace from the back slope side.

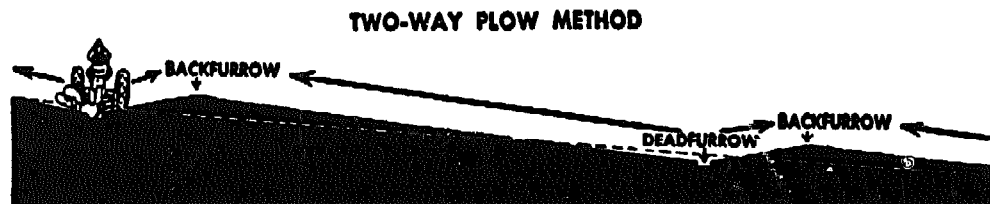

(From U. S. Soil Conservation Service Leaflet No. 335)

Fig. 9-10. Illustration showing the effect of plowing terraced land with the two-way plow. The arrows show the direction the soil is moved.

Then continue plowing the area below the upper terrace by turning all the furrows uphill.

If the terraces were parallel this could be continued

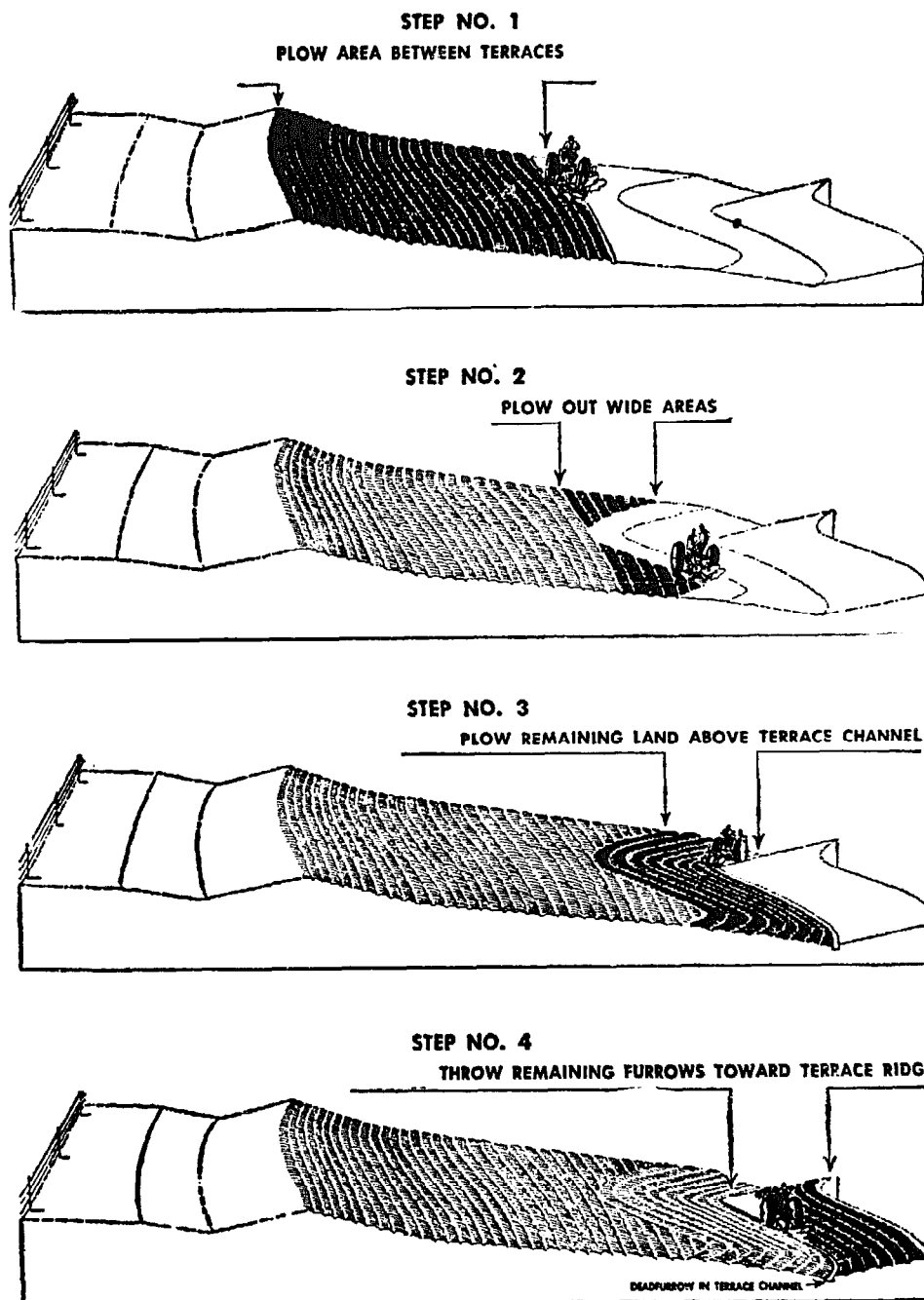

(From U. S. Soil Conservation Service Leaflet No. 335)

Fig. 9-11. Steps illustrating the plowing of terraced land with the two-way plow.

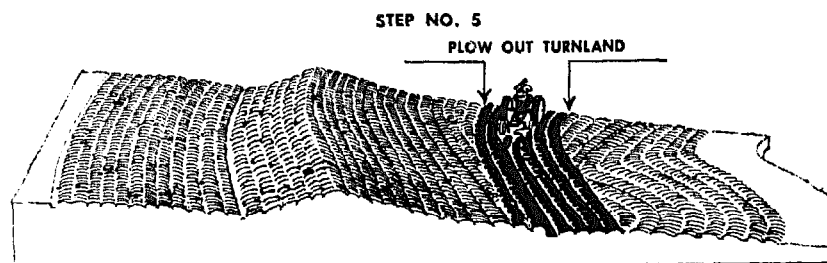
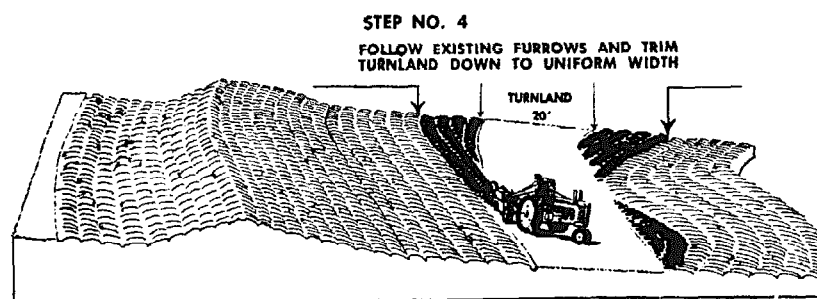
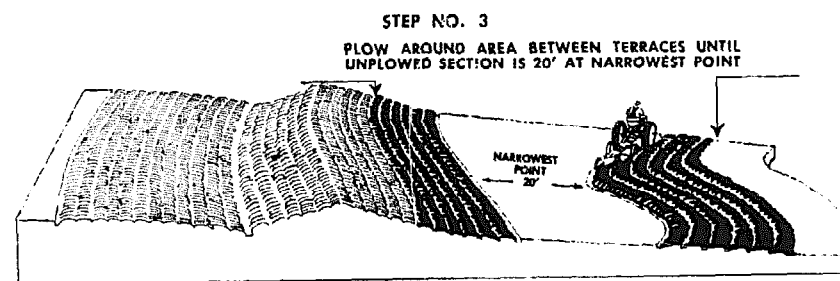
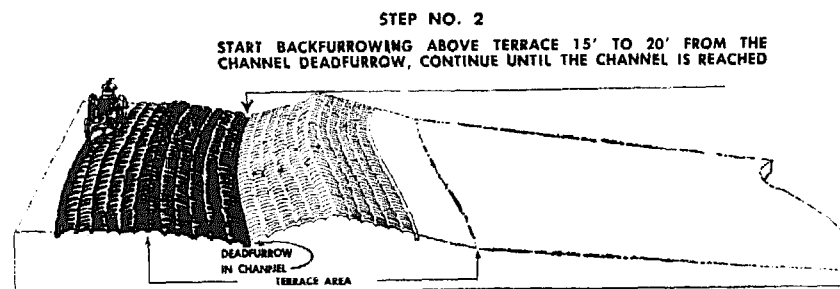
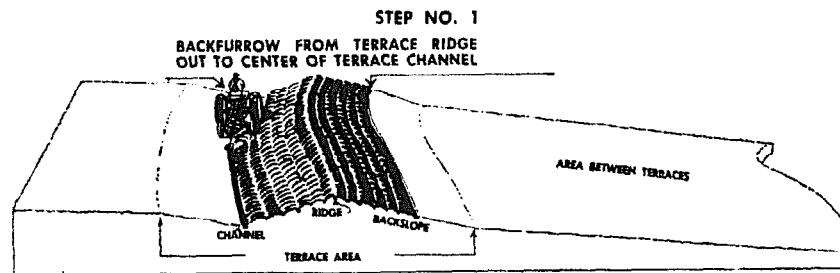

(From U. S. Soil Conservation Service Leaflet No. 335)

Fig. 9-12. Suggested procedure for plowing terraced land with the conventional plow, leaving the deadfurrow in the terrace channel.

right down to the channel of the next terrace. When the plowing approaches the narrowest place between the terraces the plow should be lifted, plowing only on the wide portion (see step 2, Fig. 9-11) leaving an area of unplowed land of even width across the field about 15 or 20 feet wide above the channel. This area should parallel the channel of the next terrace and should be plowed next, turning the furrows uphill as before. This plan makes it possible to plow the field without turning on plowed land.

After this strip is plowed, then start on the ridge of the second terrace and turn the furrows toward the ridge but toward the down-hill side of the field and continue to the channel. Continue the process to the bottom of the field.

The area above the first terrace can be plowed by starting at the field boundary and turning all the furrows uphill; any uneven area above the upper terrace can be handled as explained above.

With Conventional Plow

Plowing terraced land with the conventional plow, two methods may be used—leaving the deadfurrow in the terrace channel or leaving it between the terraces. (See Figures 9-12 and 9-13.)

To leave the deadfurrow in the channel (Fig. 9-12) start by backfurfrowing at the terrace ridge of any terrace in the field and continue plowing to the center of the channel. Then move up the slope 15 or 20 feet from the terrace channel and start another backfurrow parallel to the channel. After a little experience this can be done without staking, but at first a few stakes a hundred feet or more apart will help. Continue to backfurrow this land until the channel has been reached.

This will leave an unplowed area below each terrace.

Plow this area by going round and round it until it narrows down to about 20 feet at the narrowest place. This unplowed area will be irregular in width. Plow extra furrows on the wide portions until a turnland about 20 feet wide across the entire length of the field is left. Plow out this turnland leaving a dead-furrow in its center. The turnland may be narrower than 20 feet if small equipment is used and should probably be wider if large equipment is used.

The method just described leaves a deadfurrow in the channel and one between the terraces.

This method of plowing with the conventional plow should be alternated with one whereby only one dead-furrow is left and that between the terraces. (See Fig. 9-13.)

This is done by backfurlowing on a terrace ridge as before but continue the plowing until a land about 40 feet wide has been plowed. Do this on each terrace. Plow the remaining uneven area between the terraces as described before.

By alternating these two methods channel capacity can be maintained and depressions between terraces can be kept at a minimum.

In plowing terraced land with any method, if the terraces are already high enough the backfurrows at the ridge can be moved first to one side and then the other of the ridge. Or the plow can be kept far enough below the ridge so that the furrows just meet at the top. Experience will help in making these decisions, but extra height is usually needed to allow for the wearing down in farming operations.

13. Using Other Tillage Implements

When working terraced land for either row crops or grain, all cutting tools such as disks, field cultivators or springtooth harrows should be operated on the con-

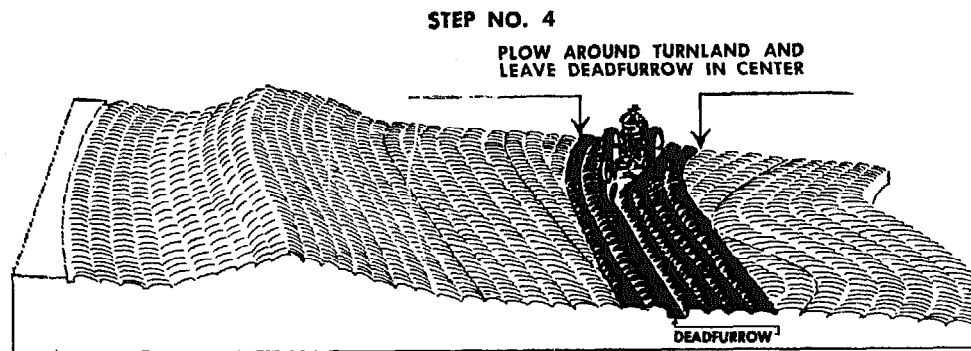
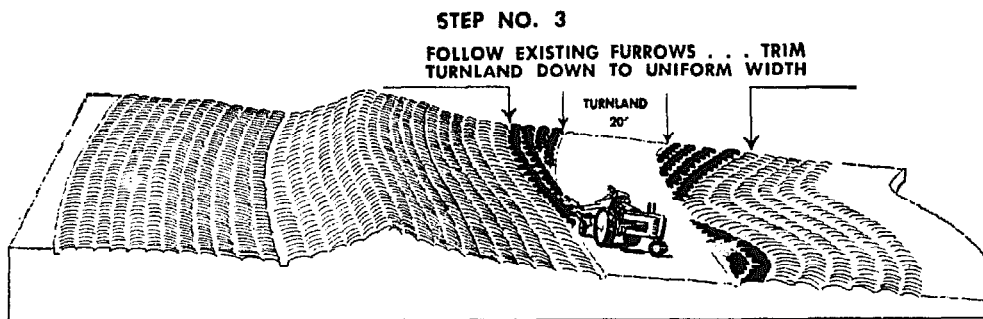
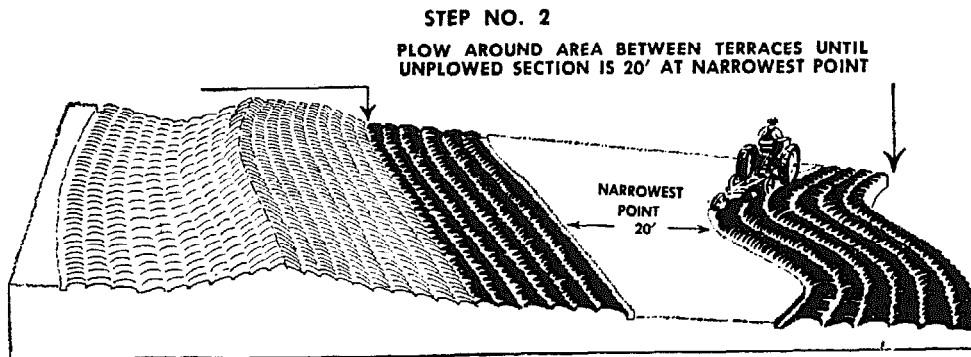
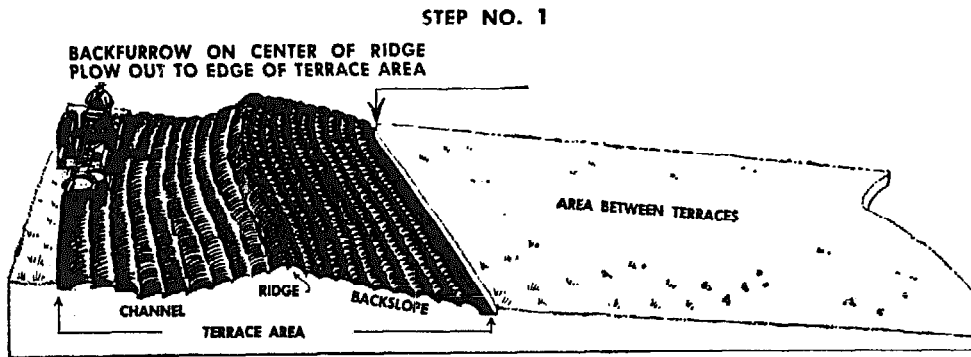

(From U. S. Soil Conservation Service Leaflet No. 335)

Fig. 9-13. Suggested procedure for plowing terraced land with the conventional plow, leaving the deadfurrow between the terraces.

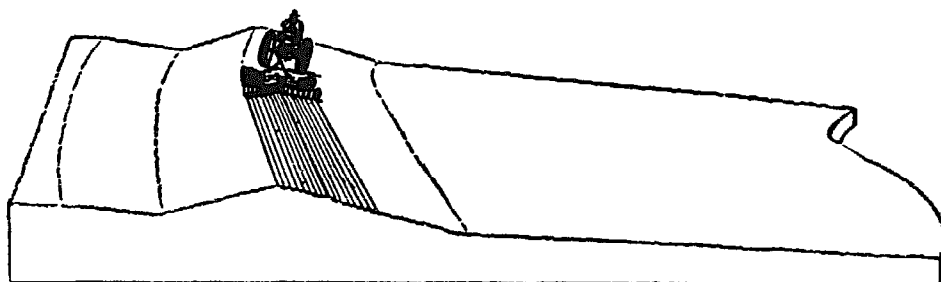

(From U. S. Soil Conservation Service Leaflet No. 335)

Fig. 9-14. Operate disks, cultivators, drills, spring-tooth harrows and other earth cutting tools on the contour, using terraces as guide lines.

tour, using the terrace as a guide line for starting the operation. (Fig. 9-14.) Also, in grain seeding it is easier, either broadcast or with a drill, to use the terrace as a guide line. Where grain is put in without plowing, corn or other clean tilled crop rows furnish a valuable guide for tillage and seeding operations.

14. Planting Row Crops

Several methods may be used in planting row crops on terraced land. Three will be described here and there may be some variations of them.

Method 1. (Fig. 9-15.)

Start planting on the up-hill side of the upper terrace. Don't straddle the terrace with the planter. (Straddling the terrace ridge with the planter will cause trouble later in cultivating.) Continue planting to the top of the slope or to the edge of the field.

Continue planting by starting on the back slope of the top terrace and plant down the slope about one-third of the distance between the first and second terrace. Then start on the upper side of the second terrace and plant up, just as with the first one, until a strip of land eight rows wide at the narrowest point is left unplanted. This remaining area will almost certainly be uneven in width.

STEP NO. 1
START PLANTING NEAR TOP OF RIDGE
CONTINUE TO TOP OF SLOPE OR BOUNDARY

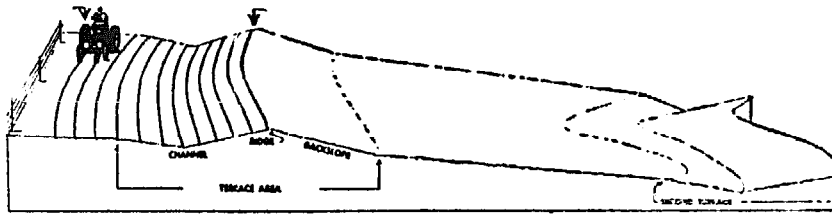

STEP NO. 2
CONTINUE PLANTING BY STARTING ON BACKSLOPE OF TOP TERRACE AND PLANT
DOWN ABOUT ONE-THIRD OF DISTANCE BETWEEN FIRST AND SECOND TERRACES

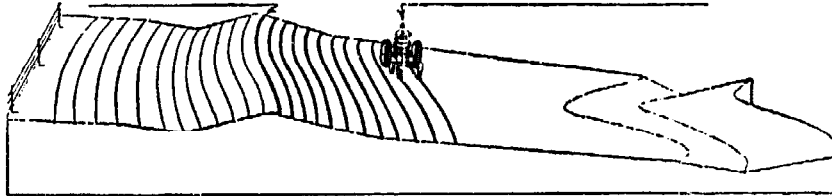

STEP NO. 3
START PLANTING NEAR THE TOP OF RIDGE OF SECOND TERRACE AND PLANT UP THE SLOPE OVER
THE CHANNEL, UNTIL A LAND EIGHT ROWS WIDE AT NARROWEST POINT IS LEFT UNPLANTED

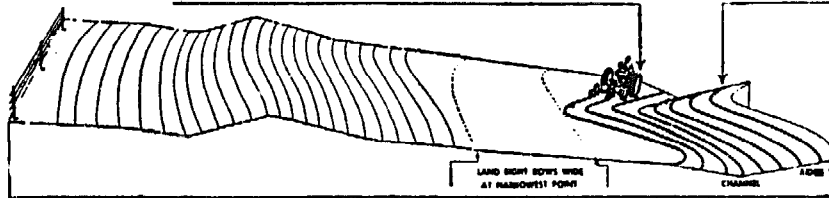

STEP NO. 4
PLANT SHORT ROWS ON WIDE PART OF THE TURNLAND
UNTIL EIGHT-ROW TURNLAND EXTENDS LENGTH OF FIELD

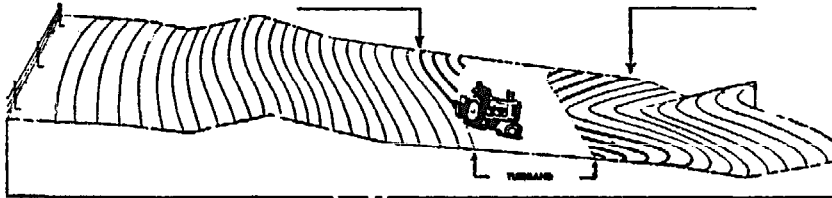

STEP NO. 5
PLANT EIGHT-ROW TURNLAND LAST
EXTEND THROUGH ENTIRE FIELD LENGTH

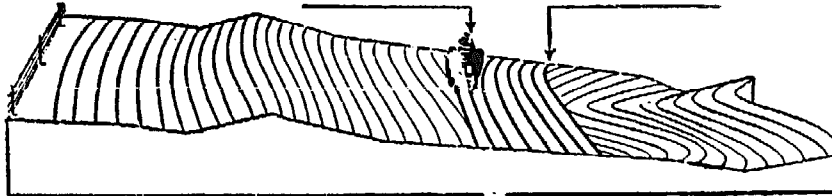

(From U. S. Soil Conservation Service Leaflet No. 385)
 Fig. 9-15. One method of planting row crops on terraced land.

Next, plant extra (shorter) rows on the wide portion of this remaining area until a strip of land is left unplanted through the entire length of the field eight rows wide. This permits planting the irregular areas without turning on planted ground.

The eight-row wide turnland is planted last. This strip may vary in width but eight rows are enough for either a two-row or four-row planter.

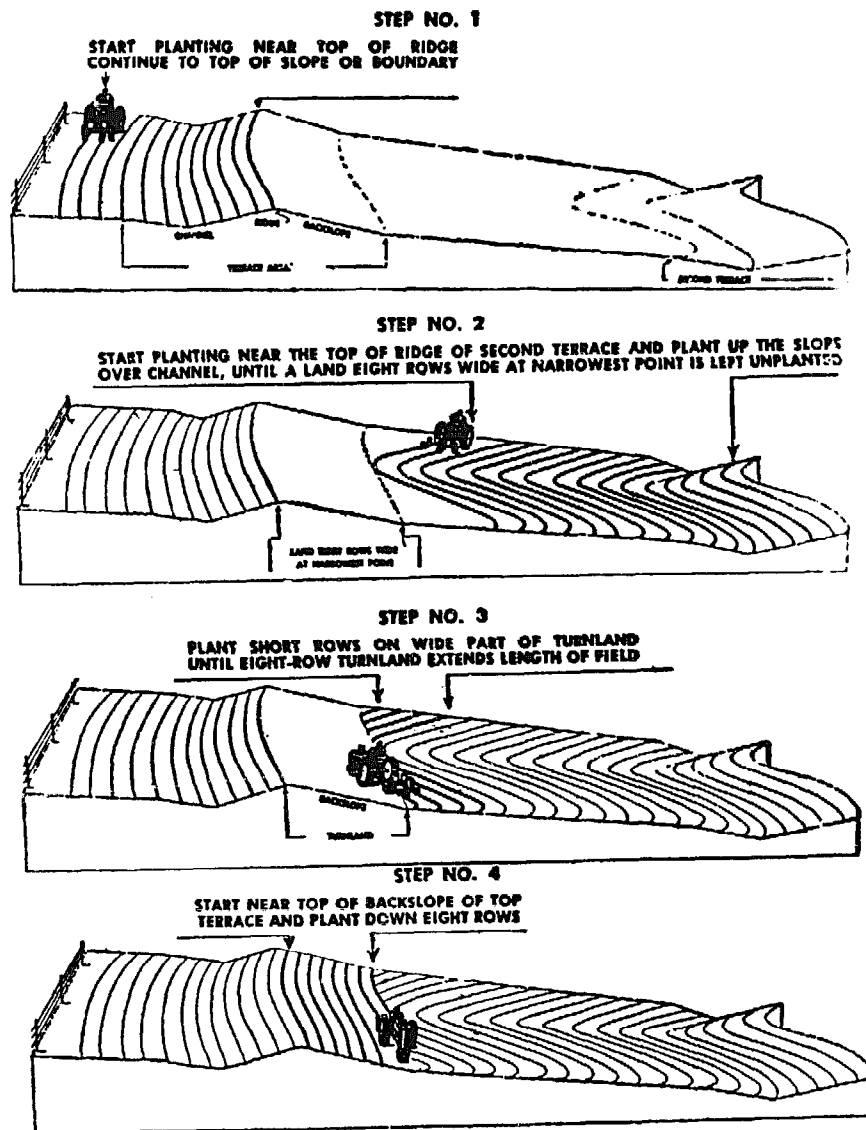

(From U. S. Soil Conservation Service Leaflet No. 335)

Fig. 9-16. A second method of planting row crops on terraced land.

Method 2. (Fig. 9-16.)

This method is started as in the first method, by starting on the upper side of the upper terrace and continuing the planting to the top of the field. Next start planting on the upper side of the second terrace and continue planting until an area of land eight rows wide at its narrowest place is left on the back slope of the next terrace above. This area, unplanted, will be irregular in width.

Now plant short rows on the lower side of this area until a strip eight rows wide extends through the en-

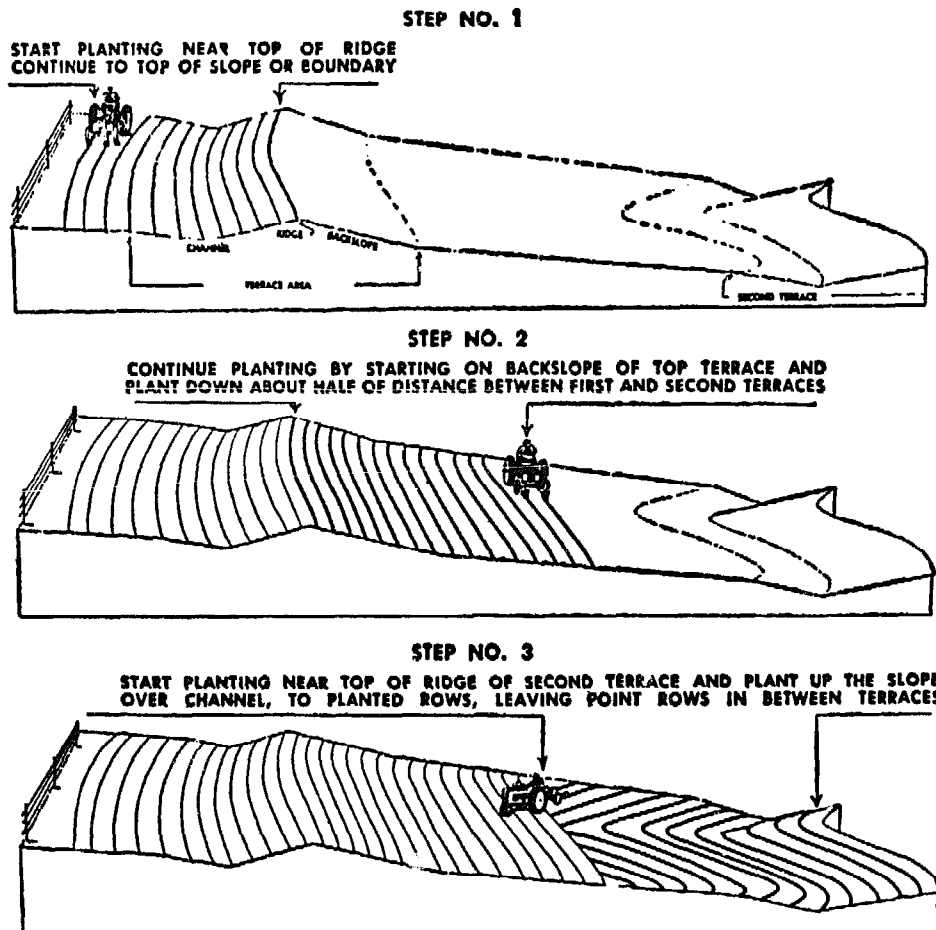

(From U. S. Soil Conservation Service Leaflet No. 335)

Fig. 9-17. A third method of planting row crops on terraced land.

tire length of the field. Plant this strip last by beginning at the terrace ridge and planting downhill.

The only difference between this method and the first one is in the location of the turnland.

Method 3. (Fig. 9-17.)

Plant above the upper terrace as in the first two methods. Then start planting on the back slope of the upper terrace and continue planting to a point approximately one-half the distance to the second terrace.

Next start planting on the up-hill side of the second terrace and continue planting until the rows join those planted. This will leave point rows near the center between terraces. These point rows can be planted either from one side (as shown in step 3, Fig. 9-17) or from both sides of the uneven area.

Continue this process with the remaining terraces. The last terrace may be used as a guide line to plant to the bottom of the field. This method is not too satisfactory with listing equipment because of the necessity of turning on planted ground.

Some farmers prefer to leave the uneven area in sod crops and not bother with point rows. (Fig. 9-18.) A temporary crop which can be harvested for hay can be used in this area if it is plowed with the rest of the field. Most farmers, however, prefer to plant the entire field and have not found the point rows difficult to manage.

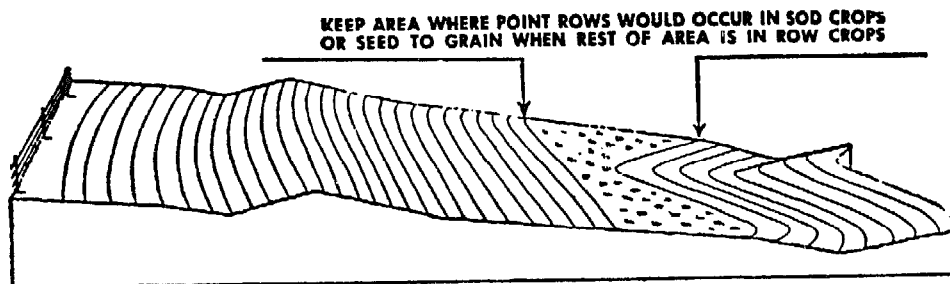

(From U. S. Soil Conservation Service Leaflet No. 335)

Fig. 9-18. Uneven areas between terraces may be left in sod crops.

Any method whereby point rows occur in the terrace channel should be avoided.

15. Harvesting Crops on Terraced Land

Harvesting small grain presents the problem of crossing the terraces at various angles with the equipment. On land that slopes less than 6 per cent the terraces can be built wide and can therefore be crossed with machinery at almost any angle. The easiest way to harvest grain on such terraces is simply to cut around the field as if the terraces were not there.

On steeper slopes, where terraces cannot be built wide, it is probably better to harvest the grain with the terraces. This will cause some waste where the tractor and equipment knock down the grain. If the

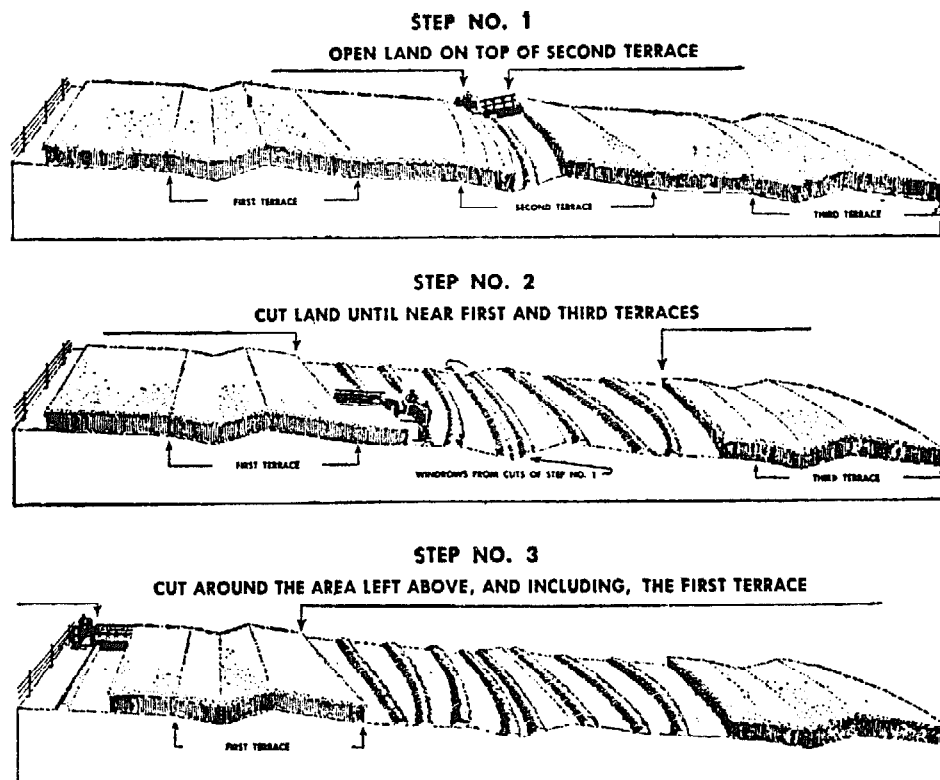

(From U. S. Soil Conservation Service Leaflet No. 335)

Fig. 9-19. Suggested procedure for harvesting small grain crops on terraced land.

terraces are nearly parallel it is best to select a key terrace—usually the center terrace. A land can then be opened on this terrace. (Fig. 9-19.) With a binder or combine this will simply mean back cutting on the ridge of the terrace selected for the key terrace. With either of these machines it is best to put the grain wheel on the terrace ridge and make a complete round. Continue cutting on this land until the next two terraces are approached. By planning ahead, wide cuts can be made on the wide places between terraces and narrow cuts on the narrow places. In this way the machine will approach the next terrace with the cut being parallel. The areas between the remaining terraces can be cut in a similar way.

Pick Corn in Reverse of Planting

Corn picking on terraces depends largely on the way the field was planted. In general, picking should be in reverse of planting. The long rows should usually be harvested first. This will leave a good sized area of picked corn to turn on in harvesting the short rows. Thus the turnland would be picked first. (Fig. 9-20.) With a two-row mounted picker this is very simple. With other pickers there will be down rows to contend with.

Next pick the point rows using the turnland as a place to turn the equipment. This leaves only the rows that parallel the terraces which can be picked in the usual manner.

Where a mounted picker is used and the wagon pulled behind the tractor, wide side boards will be needed so that corn will not fall on the ground. A shut-off on the elevator should be provided for short curves.

The procedure for harvesting corn for silage can follow the same steps as for picking corn.

In making hay on terraced land methods are similar

STEP NO. 1
PICK OUT TURNLAND FIRST

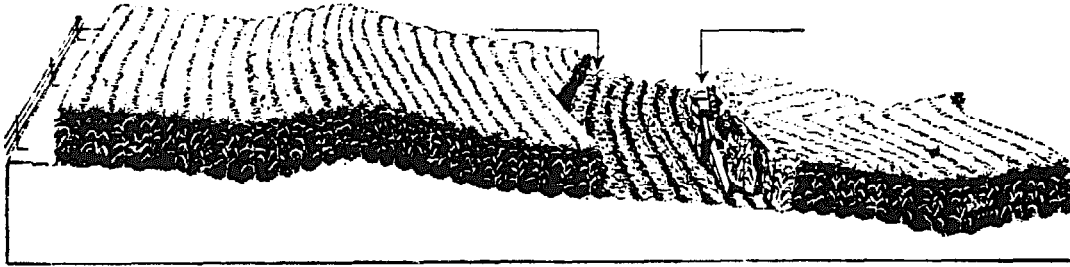

STEP NO. 2
PICK SHORT ROWS ON WIDE PART OF TURNLAND

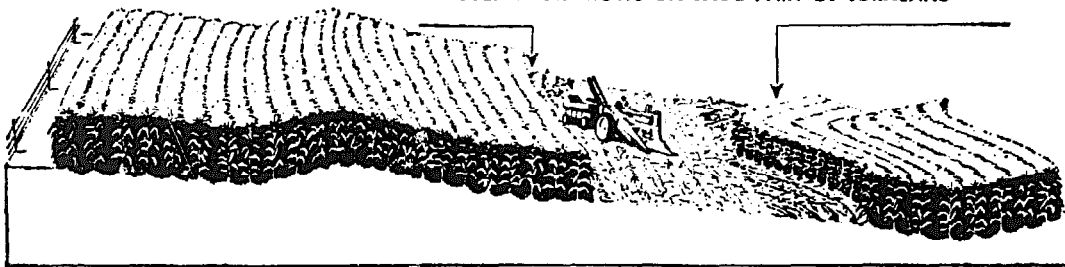

STEP NO. 3
PICK CORN BETWEEN TURNLAND AND SECOND TERRACE RIDGE

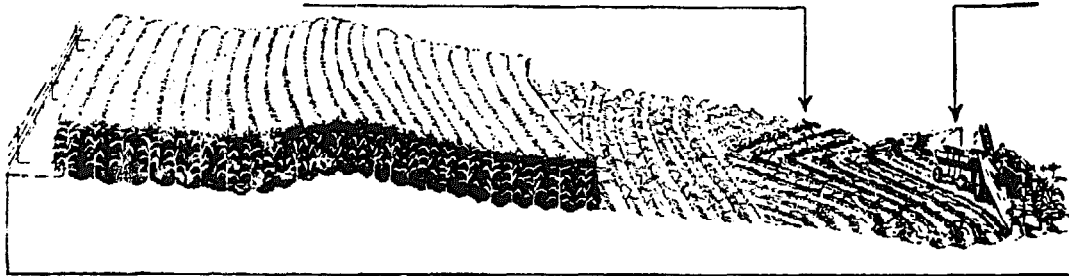

STEP NO. 4
PICK ALL CORN ABOVE TURNLAND TO FIELD BOUNDARY

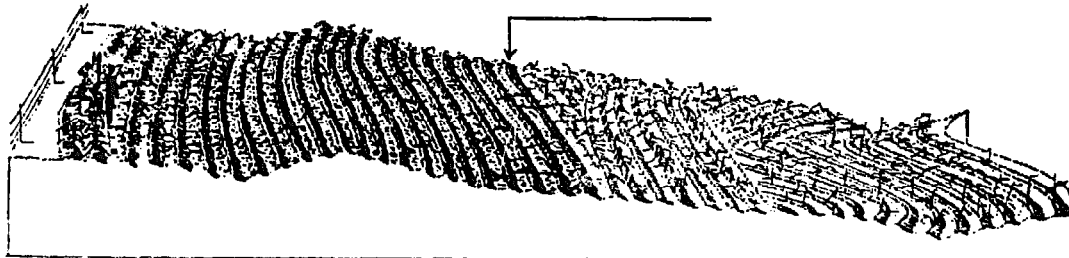

(From U. S. Soil Conservation Service Leaflet No. 335)

Fig. 9-20. Suggested procedure for harvesting corn on terraced land.

to those used in cutting grain. On land sloping up to about 6 per cent hay should be cut just as though the field were not terraced. On steeper land it will probably be better to open up lands on terraces and work each terrace as an individual unit. Using a side delivery rake presents the most difficult problem. The best starting position is to work the hay down from the top of the terrace ridge. This will leave one windrow in the bottom of the terrace channel and one on the back side of the ridge. Both of these are easily picked up with a hay loader.

16. Parallel Terraces

Recent studies show that some terraced fields can be laid out so that the terraces are parallel to each other. There are no point rows when the distance between two terraces is uniform throughout their entire length. Each row extends the full length of the terrace and all turning can be done at the ends outside the planted area.

Terraces can be built parallel where the slopes are fairly uniform from the high point of the field all the way to the bottom. Another requirement is that where cutting and filling will be necessary the soil must be deep enough that cutting and filling along the terrace line will not expose soil material unfit to farm.

It is seldom possible to have all the terraces in a field parallel, except under the most ideal conditions. Normally parallel terraces are in groups of 2 to 10 or more with the odd-shaped terrace intervals limited to the area between groups of terraces. In most fields this means that point rows will occur in only one or two places instead of between all terraces. The parts of these odd-shaped areas where point rows would occur can be planted to permanent vegetation if the farmer desires.

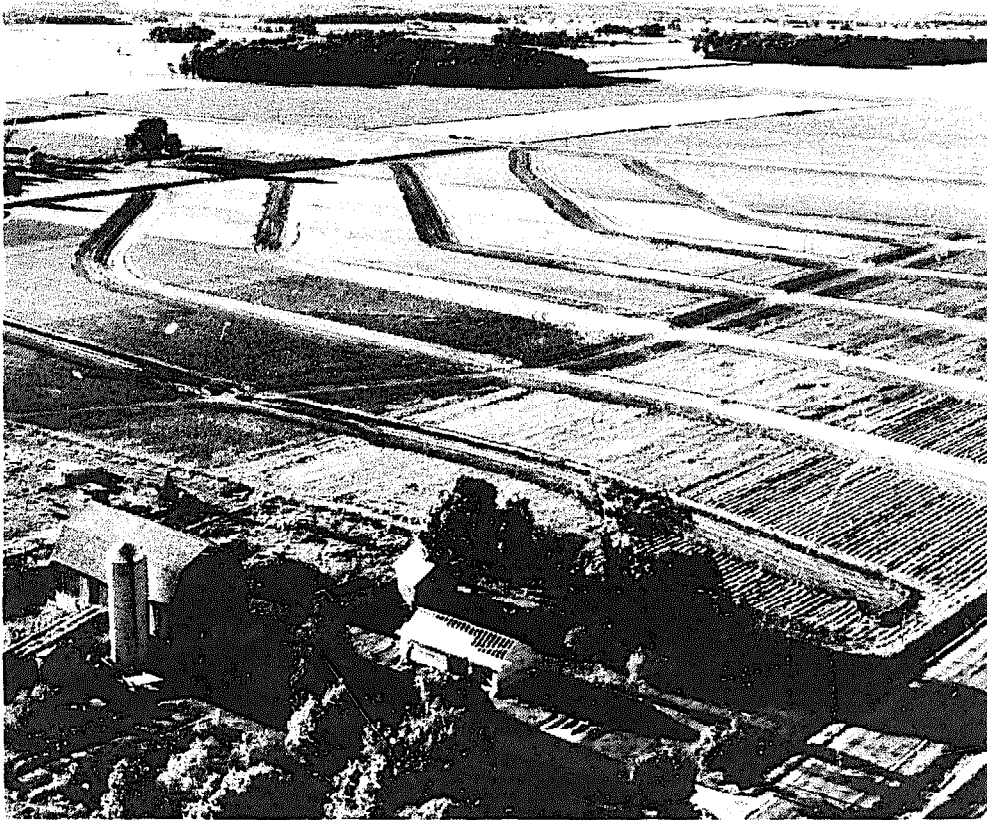

(Photo: U. S. Soil Conservation Service)

Fig. 9-21. Forty acres of parallel terraces completed with a grader.

Laying out and building parallel terraces is an altogether different job than building conventional terraces.

First, locate all ridges and depressions in the field. All terraces will be graded to drain from the ridges toward the natural depressions which will be used as grassed waterways.

Next, stake a key terrace on the grade recommended for the soil; adjust the staked line to ease sharp curves as much as possible. All stakes moved in making the adjustment must be rechecked with the level to be sure that the grade from ridge to depression is continuous and not excessive. The key line will be laid out in a uniform part of the field slope. Insofar as

topography will permit, the other terraces will be built parallel to this line. Note that this is different from the procedure in laying out terraces in the regular way where the upper terrace is staked first.

The third step is to stake a trial line above and below the key line and parallel to it. The terrace interval will be figured as already described earlier in this chapter. Have one man walk along the key line carrying one end of a tape. A second man, holding the tape at a point marking the proper distance between terraces, keeps pace with the first man, setting stakes to mark the trial line. This line is then checked with the instrument. The location is accepted if the grade is not excessive or does not reverse anywhere along the line. Continue laying lines in this way above and below the key line until the grade in a new line becomes excessive or reverses. When this happens, lay out a new key line. The distance you move to start the new line will depend on the nature of the slope but try to lay it out within another uniform area and repeat the procedure of laying out parallel lines above and below it.

This gives two sets of terraces, all those in each set being parallel to each other. The only short rows will be in the small adjustment area between the two sets of terraces. Some fields may require several sets of parallel terraces.

On some fields it may be necessary to do considerable land smoothing and cutting and filling along the terrace lines for terraces to be parallel and have acceptable grades. In these cases an average grade is calculated for a terrace and cut and fill stakes set to give this grade. Different grades may be used for different segments of a terrace if this will give better alignment or reduce the cuts and fills.

With some parallel terrace systems all the draws that are a part of the surface drainage system will be used as waterways in which to empty the terrace water. This

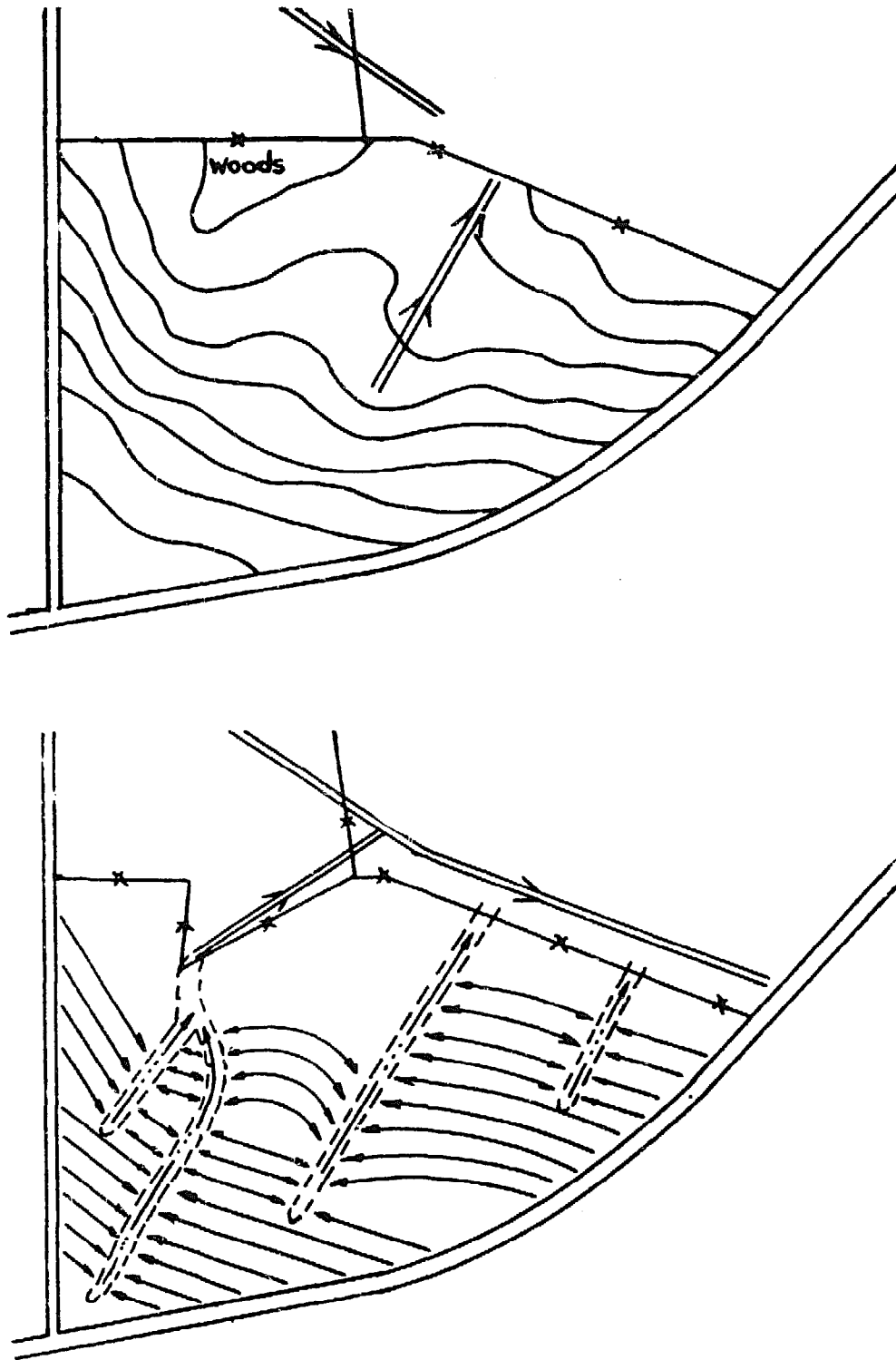

(Drawings: U. S. Soil Conservation Service)

Fig. 9-22. This field has regular terraces (top) and parallel terraces (bottom). With careful planning several sets of parallel terraces are worked out. Additional waterways are used. The only point rows are in the area between sets of terraces.

probably calls for more waterways than the farmer is accustomed to, but good terrace alignment cannot be had if terraces run across these natural drainageways. Waterways are easy to cross with present-day power-lift equipment.

The objections to too many outlets can be avoided by the use of underground outlets made of conduit tile, pipe, or other suitable material. With this system the terrace channel is graded to the outlet as with all gradient terraces. However, the terrace ridgetop usually is built level to provide capacity to store the design storm runoff.

The tile is laid in the natural waterway deep enough to be safe from damage by normal farming operations. Water enters the conduit through an intake placed in

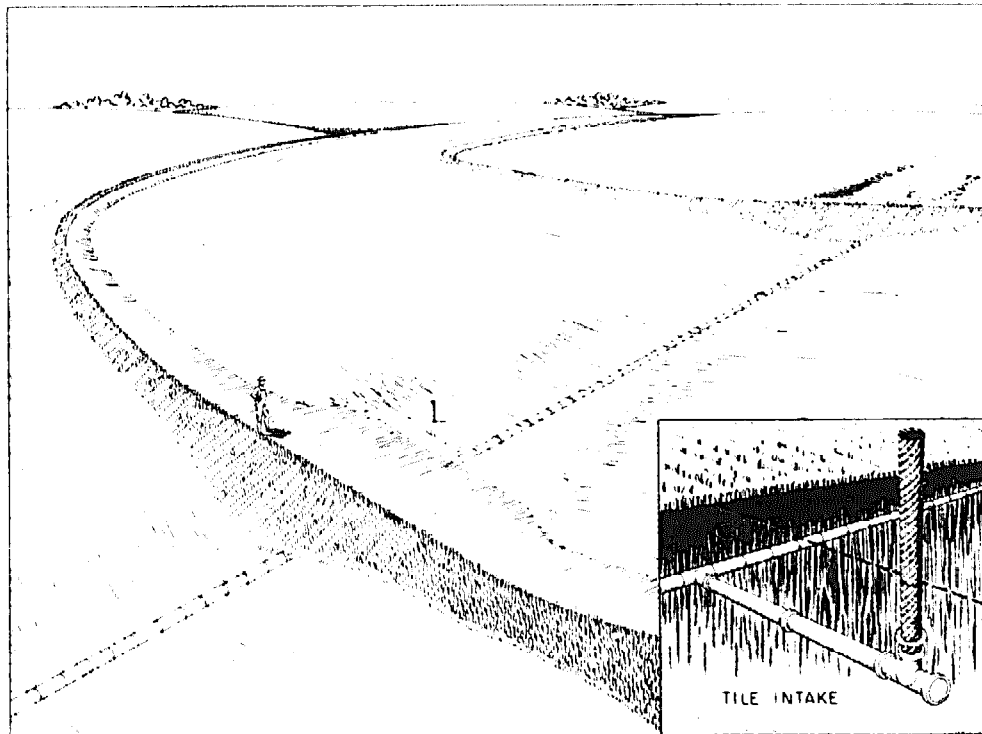

(Drawing: U. S. Soil Conservation Service)

Fig. 9-23. The tile outlet makes parallel terraces easier to design and build. Terraces are built level across draws, eliminating sharp curves. Water enters the tile through an intake placed in the terrace channel.

the terrace channel. The outlet conduit is designed to remove the runoff gradually but soon enough that crop damage does not occur.

The main advantages of the underground outlet are that it promotes parallel alignment and eliminates the need for grass waterways. Terraces must be built across the depressions and waterways with the intake being placed at the low point in the terrace profile. Where depressions are shallow the terraces can be built straight across, thus giving a straighter line than if a surface outlet is used.

By eliminating the surface outlet, more land is in crops in a terraced field. Another advantage of the underground outlet is that it provides a certain amount of land restoration or topography improvement. If the natural waterways are rather deep, an intake placed at these low points with a fill straight across the waterway will trap any sediment that moves. This accumulation of sediment will eventually level out the area and provide a more farmable land surface.

The underground outlet is adapted to soils of low to moderate permeability in all rainfall areas. It is particularly adapted to topography where waterways are shallow and numerous. It is especially valuable where waterways are difficult to maintain. Another advantage of the underground outlet is the fact that it is easier to build terraces parallel on rough topography. In addition, the alignment can be greatly improved in terrace systems that were not originally planned to be parallel.

There are locations where both surface and underground outlets should be used in order to provide the best terrace system. Where straightening the alignment and developing a good sod are not a problem, the vegetative outlet might work better for a part of the system. In another part of the same system, with rougher topography and deeper draws, the tile outlet might be suitable.

The topography of the field and the location of the outlets should be studied carefully before deciding what combination of underground and surface outlets to use. The help of a professional conservationist would be very valuable here.

Constructing Parallel Terraces

Parallel terraces can be constructed with graders, terracers, or plows, just as with regular terraces. There may be places, however, where it is necessary to do some cutting and filling along the terrace line. Some actual field grading may be needed in some instances such as smoothing down surface irregularities in the land in order to keep the terrace lines as uniform as possible. Where cutting and filling are necessary, it has been found that the costs are reduced by using a bulldozer as much as possible. After the main move-



(Drawing: U. S. Soil Conservation Service)

Fig. 9-24. Cut and fill parallel terraces. The dotted lines show where standard terraces would have been located.

ment of earth has been done with the bulldozer, final shaping can be done with a grader.

Grass Back Slope

On gentle slopes terraces can be built broad and are easily worked with big machinery on both the upper and lower sides of the terrace. On steeper slopes—about 8 per cent or steeper—the back slope of the terrace is so steep that farm machines may overturn. It may be desirable, therefore, to leave the back slope of the terrace in grass on these steeper slopes. If the back slope is to be left in sod it should be graded to a slope of about 2 to 1. This is too steep for row crops. The front slope can be made to fit farm equipment.

There are additional advantages of leaving the back



(Photo: U. S. Soil Conservation Service)

Fig. 9-25. Parallel grass backslope terraces in Minnesota. This type of terrace is suitable for steeper slopes where the backslope of the terrace may be so steep it is hazardous to farm.

slopes of terraces in grass. The slope of the land between terraces is reduced. Less earth is required in the heavier fills. And the safety hazard associated with farming steep back slopes is removed.

Maintaining Grass Back Slope Terraces

Maintenance of terraces with grass back slopes is considerably different from that of broad-based terraces. Plowing is easier, in that the land can be plowed more like level land—one year with the dead furrow in the center between terraces, and the next year with the backfurrow in the center. This will not maintain terrace height, but will retain the general cross section of the terrace interval. The terrace ridge will have to be raised occasionally by extra plowing, or by using construction equipment.

The grass back slope is a critical area to maintain. A good sod should be established and maintained; trees

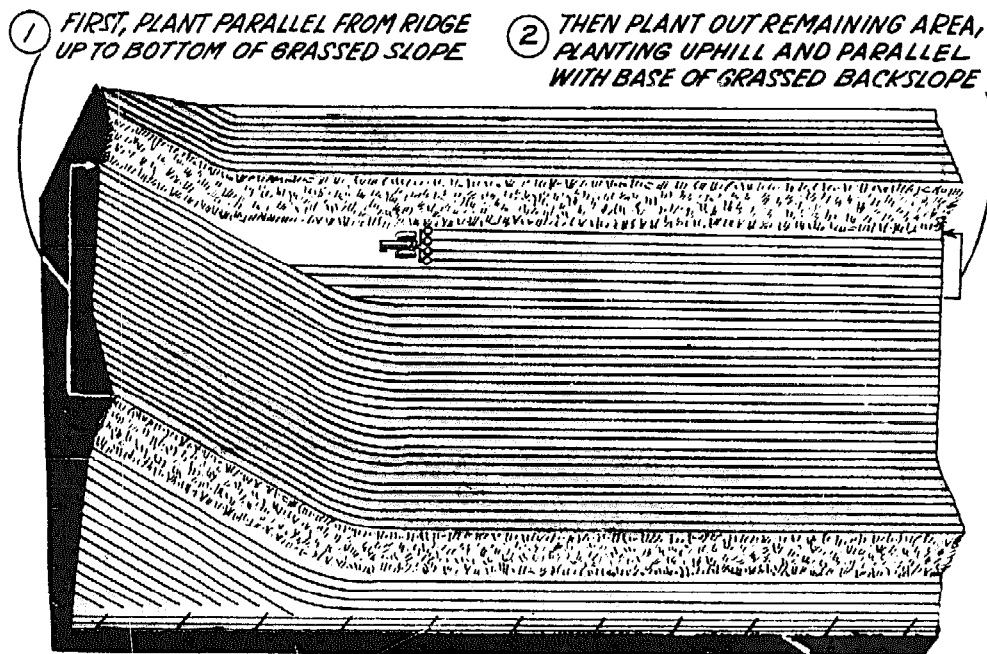

(Drawing: U. S. Soil Conservation Service)

Fig. 9-26. A method of planting row crops on grass back-slope terraces.

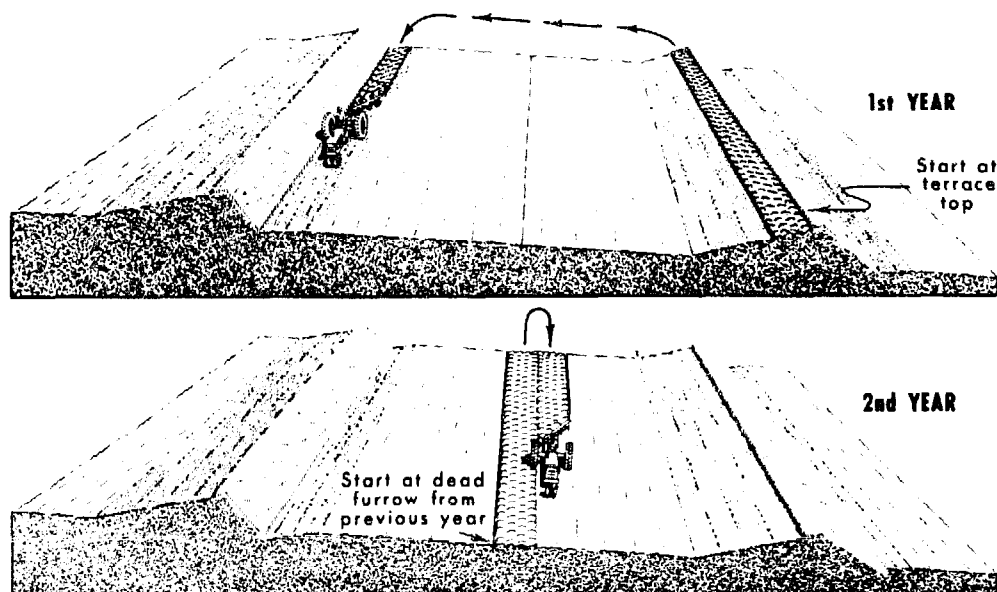

(Drawing: U. S. Soil Conservation Service)

Fig. 9-27. Suggested method of plowing a field with grass backslope terraces.

and brush growth should be controlled by spraying or mowing; and gophers and burrowing rodents should be eliminated from the slope area. Occasionally the slope should be fertilized to maintain a vigorous sod.

It is a good idea to get help from experienced technicians in planning parallel terraces such as from the Soil Conservation Service or specialists with the Extension Service. This help will be valuable to you in sizing up the field ahead of time to see if parallel terraces are feasible, and to assist in adjusting the lines so that they will fit together into a coordinated parallel system.

17. Using Diversions

A diversion is an individually designed channel constructed across the slope for the purpose of intercepting surface runoff and conducting it to a safe outlet.

Diversions are used (1) to reduce the length of slope, (2) to divert water out of active gully overfalls,

(3) to divert water away from farm buildings, (4) to protect bottomland from overflow, (5) to cut off headwater from the top terrace of a terraced field where the land above is not terraceable because of topography or land ownership.

The drainage area above a diversion must be managed in a soil conservation program, otherwise soil losses from erosion will fill the channel and cause failure. Filling of channels is the reason for most diversion failures.

The diversion itself should be kept in grass, although diversions may be designed for bare channel conditions. Unlike terraces, which are designed to be farmed over with the regular tillage tools, diversions usually must carry more water; thus it is usually necessary to give them steeper grades than terraces. They should be designed so that the velocity of the flow will not damage the vegetation used.

Diversions should not be used as a permanent control on fields which can be terraced.

On strip-cropped fields they should ordinarily not be of greater spacing than the width of three strips.

Location and Spacing

Where diversions are used with strip cropping to reduce the length of slope, the spacing will vary according to the soil type, the expected rainfall and runoff, the width of strips and the crop rotation used.

Diversions are very useful and satisfactory in diverting water from the head of a gully in a pasture. Here conditions are satisfactory for the proper protection of the channel from silting. The diversion should be located far enough above the head of the gully overfall so that a stable slope can be maintained. Some sloughing is bound to occur and allowance must be made for it.

Where diversions are used to protect bottomland

from overflow, the diversions should generally be located just above the cropland area.

The outlet where the diversion empties is an important feature. The water should be spread on good grass so that there is no danger of erosion starting, or else, if the diversions empty into a draw, a grass waterway should be prepared or a permanent structure built, depending on the condition.

Design of Diversions

Diversions should ordinarily be designed so that the velocity of the flow will be as high as possible and still not damage the vegetation used in the channel. Ordinarily safe velocities are:

Bare channel

Sand—1.5 feet per second.

Other—2.0 feet per second.

Poor channel vegetation—3 feet per second.

Fair channel vegetation—4 feet per second.

Good channel vegetation—5 feet per second.

The first step in designing a diversion is to determine the watershed area that it must handle. This area should be measured at the diversion outlet. (If there are to be changes in grade in the diversion, then separate design must be made at each point and the watershed area at these points is also needed.)

Obtain the maximum rate of runoff for 10-year frequency from Table 4-2 in Chapter IV. This means it will be necessary to make a study of the watershed and summarize the characteristics of it as is done for waterways and structures.

After calculating the expected runoff rate, determine the channel size needed by using Table 9-5. From the chart select the bottom width, depth, and grade for the required runoff, based on a safe velocity for the type of vegetation planned for the diversion.

TABLE 9-5. Diversion design chart.

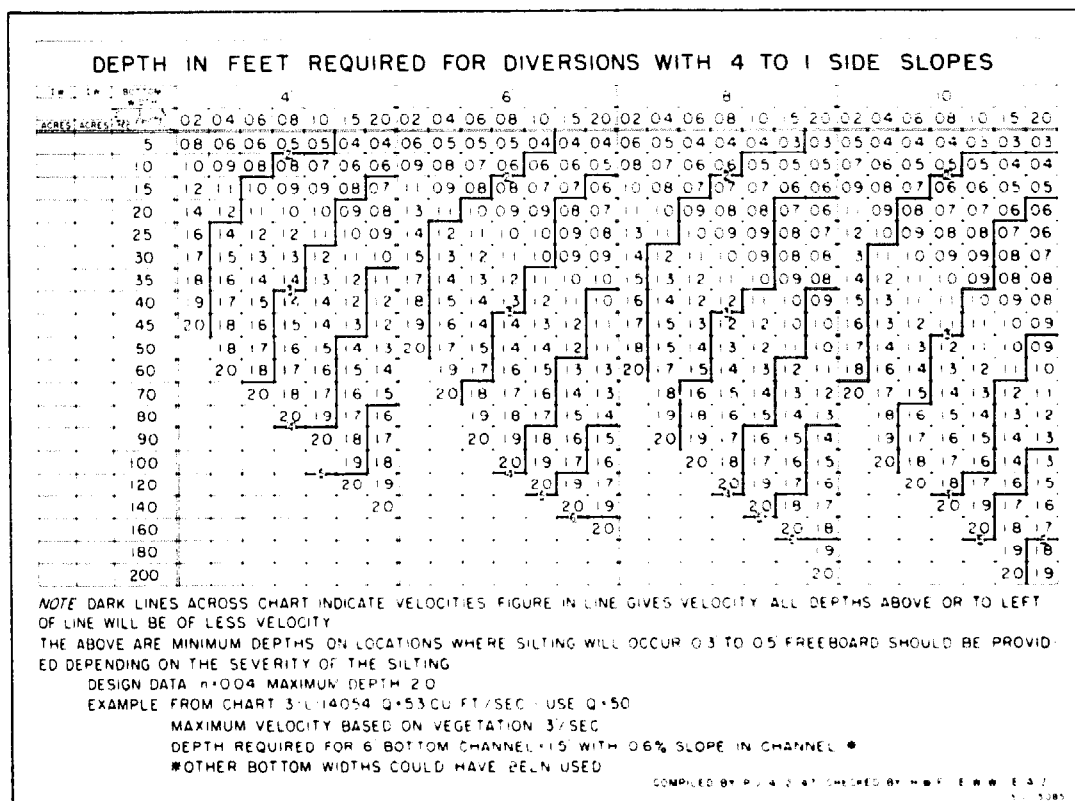

(From U.S.D.A. Handbook No. 135)

For example, supposing the diversion must handle a runoff rate of 30 cfs. Enter the chart at the left at the line at "30" and move to the right to the desired bottom width. If the channel is expected to have fair vegetation you can use up to 4 feet per second velocity. If you decided to use a 4-foot bottom width, move to the right to the figure 1.0. (Note the heavy stair-step lines that separate velocities.) This means the channel would be one foot deep. Moving up the column to the top you come to the figure 2.0 which indicates a grade in the channel of 2 per cent. If you wanted to use a 6-foot wide channel, and 3 feet per second velocity, (poor vegetation) move over under the 6' column to 1.0. The depth would be 1.0 foot and at the top of the column the grade is 1 per cent. Many possibilities are offered

in the table by using different bottom widths and different velocities.

It is important to remember that velocities are based on channel vegetation. In most cases this will mean that you will design for either a low velocity based on a bare channel, or a high velocity based on degree of vegetation. Usually poor vegetation will not be a permanent condition and, therefore, channels should not be designed on this basis.

Laying Out and Constructing Diversion Channels

The best time to build diversions is when the watershed area is mainly in grass so that channel silting and runoff will be at a minimum.

Use the same general procedure in laying out diver-



(Drawing: U. S. Soil Conservation Service)

Fig. 9-28. Diversion protecting a cultivated field from runoff from an unterraced field.

sions as is used in terraces. A uniform grade may be used throughout the length, or the grade may be changed as you go upstream. When the grade is changed the size of the diversion should be determined at each point where a change is made.

After the diversion is staked it can be constructed similar to a terrace. Since it is being built across the slope, not up and down, the diversion will have the same general features as a terrace, with a ridge on the downhill side and a channel above.

During construction it should be checked with a level, both in the channel and on the ridge. Checking is important to determine the adequacy of the completed job. It is also a good idea to keep notes of level readings to serve as a permanent record for future reference in checking the performance of the diversion. This is a good idea in all conservation jobs requiring engineering survey methods.

Maintaining Diversion Channels

Good vegetation should be established and maintained in the channel and on the upper back slope, unless it was designed for bare channel conditions. Mowing is necessary to prevent the growth of briars and other brushy growth which may obstruct the flow. When woody growth gets too large mowing is impossible and the diversion channel gradually becomes ineffective and generally results in failure.

It may be necessary to remove silt accumulations occasionally. Small silt deposits may be removed with a shovel or slip scraper. However, if the silt deposit extends the full length of the diversion, the channel should be plowed out as in terrace maintenance plowing. Excessive channel silting usually indicates that an inadequate conservation job is being carried out on the watershed.

Diversions left in permanent vegetation sometimes attract rodents, particularly ground hogs. The ridge should be observed at the time of mowing, and if any holes or breaks are seen they can be repaired with a shovel. A rodent hole is easy to repair if done immediately. However, if the water breaks through it may erode to such an extent that considerable effort and time are necessary to make the repair.

Chapter

X

MINIMUM TILLAGE

Research is showing that excessive tillage can cause soil erosion. Row crops such as corn, sorghum, soybeans, and milo give least protection to the soil when they are young, and right after harvest. And since severe, erosion-causing storms are most likely to occur in late spring and early summer, some form of erosion protection is especially important during seedbed preparation, planting, and the early growth stage of the crop. In the conventional system of growing corn, for example, land preparation includes early plowing, several diskings, and one or more harrowings with a spiketooth or drag harrow. Corn is planted with a runner-type planter; cultivations with a shovel-type cultivator start early and are frequent.

With the advancement in farm equipment in the last 15 to 20 years, farmers are finding it possible to plant and harvest crops with a minimum amount of soil stirring and at the same time make use of stalks, stubble, and other crop residues. Other changes, in addition to better equipment, that make some of these minimum tillage operations possible include:

1. Increased use of fertilizer—particularly nitrogen—which makes it possible to utilize large amounts

of crop residue without robbing the soil of its nitrogen supply.

2. Chemical herbicides that eliminate the need for early and excessive cultivation. Directions on the application of chemicals should be followed closely.
3. Insecticides that control insects harbored by plant residues.
4. Widespread adoption of improved seeds, including hybrid corn that has high-yielding capacity and increased vigor.

These new minimum tillage methods go by different names in various parts of the country, and there are a number of variations of them. Some of the methods

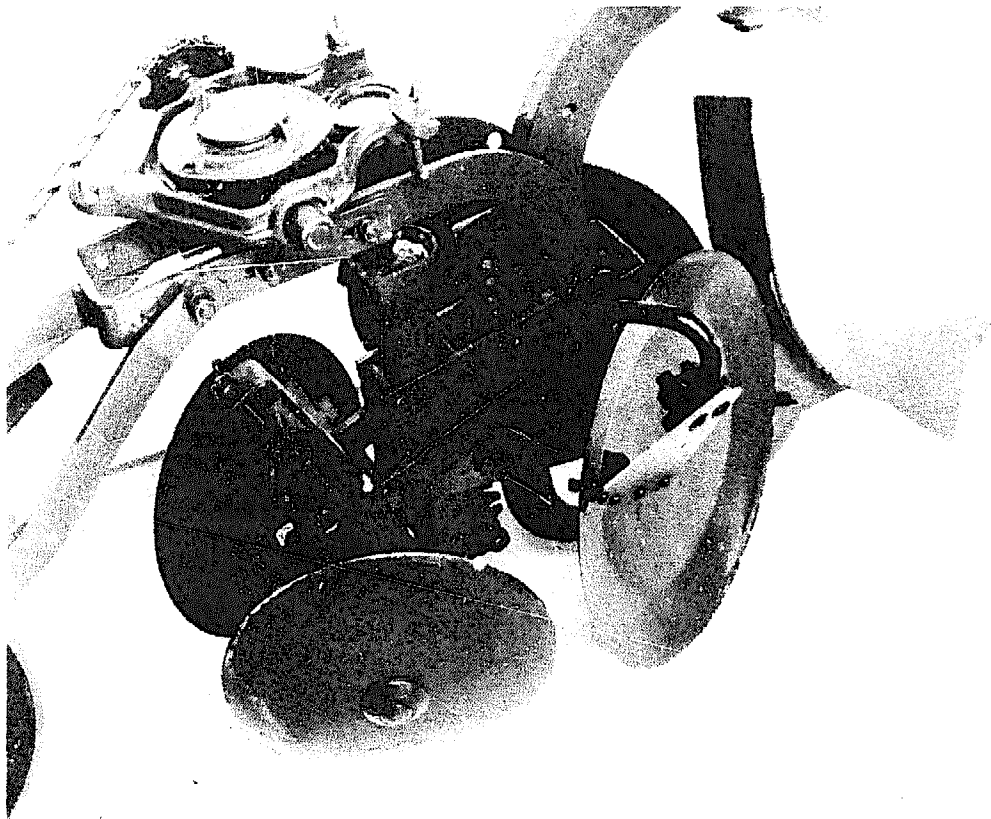

(Photo: International Harvester Co.)

Fig. 10-1. Rotary moldboard type lister planter used for planting in crop residues without prior land preparation. Planter is mounted to rear tool bar attachment of tractor.

used by farmers today are called no tillage, zero tillage, slot planting, chisel planting, till planting, strip tillage and simply mulch tillage. They are all forms of mulch tillage and that term will be used here in discussing the system in general. The key point is that they eliminate plowing.

Mulch tillage saves time and labor—and therefore money, at least \$10 an acre—and at extremely busy times of the year. It saves because you don't have to burn, plow, disk, or harrow before you plant row crops. In the spring you can plant at the time you would normally be plowing. And after grain harvest your planter can follow right behind your combine. In fact, mulch tillage works well with double-cropping systems in which either corn or soybeans follows small grain. Since either crop can be planted immediately after the grain is combined, farmers in the South can take full advantage of the long growing season.

Mulch tillage saves both soil and moisture. Moreover, it makes use of crop residue to improve the soil structure or tilth, maintain organic matter, and provide good working conditions for soil bacteria.

Winter cover crops and crop residue can remain on the land longer in winter and into late spring, giving longer protection against wind and water erosion.

Mulch tillage supplements terracing, stripcropping, and other well-known erosion-control practices for sloping land. On gentle slopes mulch planting on the contour may replace terracing and stripcropping, since each furrow acts as a miniature terrace.

There are some disadvantages. Mulch tillage is not well adapted to slowly drained soils. Moreover, it may not be satisfactory in a crop system where corn follows a perennial grass-legume sod, because it may be difficult to kill the perennial grasses, particularly in wet springs.

Most residues used in mulch tillage tie up available

soil nitrogen as they decompose. Therefore, more nitrogen fertilizer will be needed. Some soils also require more potash fertilizer. Soil temperatures are lower under mulches and corn may start off more slowly, especially in cool, wet seasons. Yields may be slightly lower with mulch tillage, but this is more than compensated for by savings in other ways.

Special care is required in planting to make sure seed falls in firm, pulverized soil and that residues do not clog the planter.

Mulch tillage became popular in the southeastern Coastal Plains and was described in detail in U. S. Department of Agriculture Leaflet 512, "Mulch Tillage in the Southeast," published in 1962. Some farmers in other sections of the United States, more particularly in the Corn Belt, had also been practicing forms of minimum tillage. And various state experiment stations, in addition to the U.S.D.A. Hydrologic Research Station at Coshocton, Ohio, had been carrying on work in this field. In addition, farm equipment manufacturers helped by developing various machines that facilitated the minimum tillage technique.

Soils Suitable for Mulch Planting

Mulch planting has had its widest acceptance in areas where soils with sandy loams and loamy sands are common. Such soils permit direct planting without any land preparation beforehand. These soils are common in the Coastal Plains area of the southeastern United States. In slightly heavier soils such as silt loams, loams, and silty clay loams, the technique may need to be varied somewhat. It may be necessary to go over the field with a field cultivator or similar tool that will loosen the soil to a depth of 6 inches without inverting it and that will leave the mulch on the surface. This would work where a row crop is being planted in

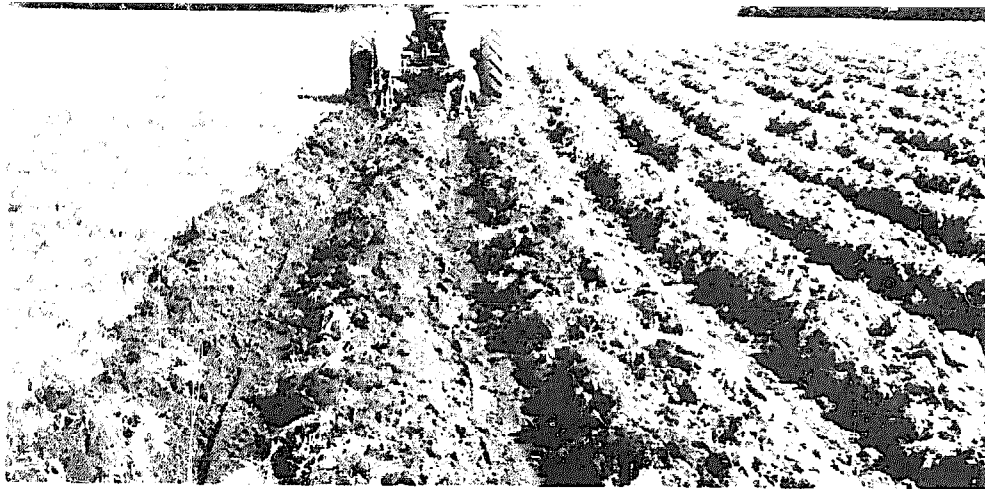

(Photo: U. S. Soil Conservation Service)

Fig. 10-2. Planting corn with the lister planter direct in sod.

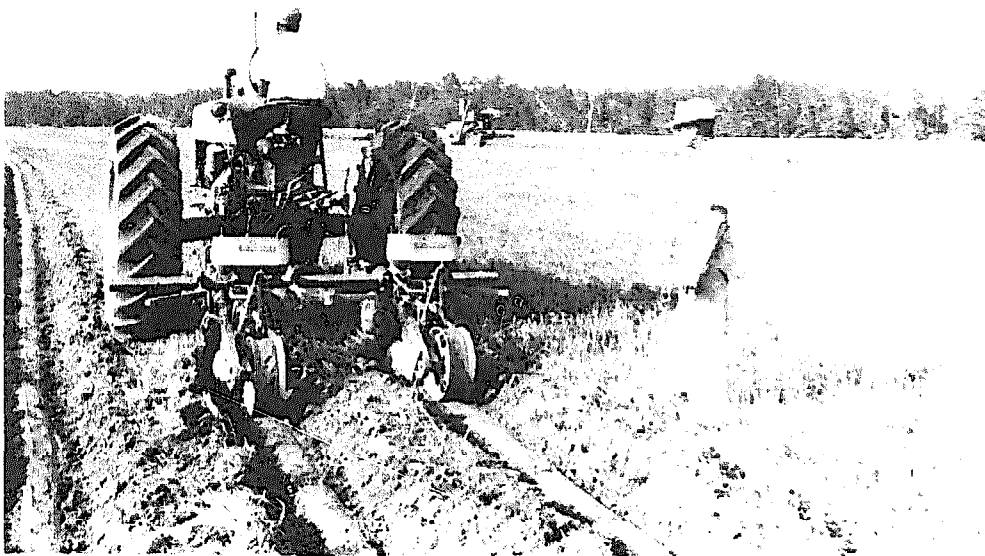

(Photo: U. S. Soil Conservation Service)

Fig. 10-3. This farmer is mulch planting soybeans following combined oats. The combine is still at work.

the stubble left following a small grain crop. Where corn follows a grass-legume crop on these heavier soils it may be necessary to use the plow-plant or wheel track method, which will be described later. However, many farmers are finding that they can plant directly in the heavier soils if they use the right equipment, such as the rotary disk with the hard ground opener. Much depends on the conditions at the time of planting.

Planting Equipment

All mulch tillage units on the market till and plant in the residues of corn, soybeans, and small grain, but some units operate better than others in sod. Modern mulch tillage machines can prepare a seedbed, apply fertilizer, plant the crop seed, and apply herbicides in one operation. No piece of equipment is best suited for all conditions. A farmer should evaluate all the mulch tillage equipment available for producing his crop, such as corn, sorghum, or soybeans, in his climatic area, on the particular soil he has on his farm, and with his available labor and power. Approximately \$1 a mile should be charged to pulling the average tillage implement with a tractor, so it pays to hold trips across the field to a minimum. Since most tillage operations are done at about 4 miles an hour, each hour of tillage eliminated saves \$4. (Many farmers have reported that changing from conventional tillage to mulch tillage saves \$8 to \$14 an acre.)

In the Southeast lister planters in standard production have been adapted for direct planting in residues. Two types have proved satisfactory. One is the rotary disk with hard ground openers. The other is the middlebuster opener. The rotary disk makes a wide sloping furrow and rounded row middle. The middlebuster makes a vertical furrow and flatter middle than the rotary disk.

The lister does both land breaking and planting in one operation. About one-third of the row width is disturbed. Moisture is held in the row middle for use as the plant grows. In heavy soils a subsoil-type seed-furrow opener does the best job of planting. In lighter soils the runner type is satisfactory. Rear-mounted covering disks move clean, loose soil from the side of the furrow on the seed ahead of the planter press wheel.

Only the soil next to the seed need be firm—it is the close contact between seed and soil that gives quick germination. If the soil between the rows is stirred and then packed, you have a good seedbed for weeds and grass. In mulch planting, since the soil between

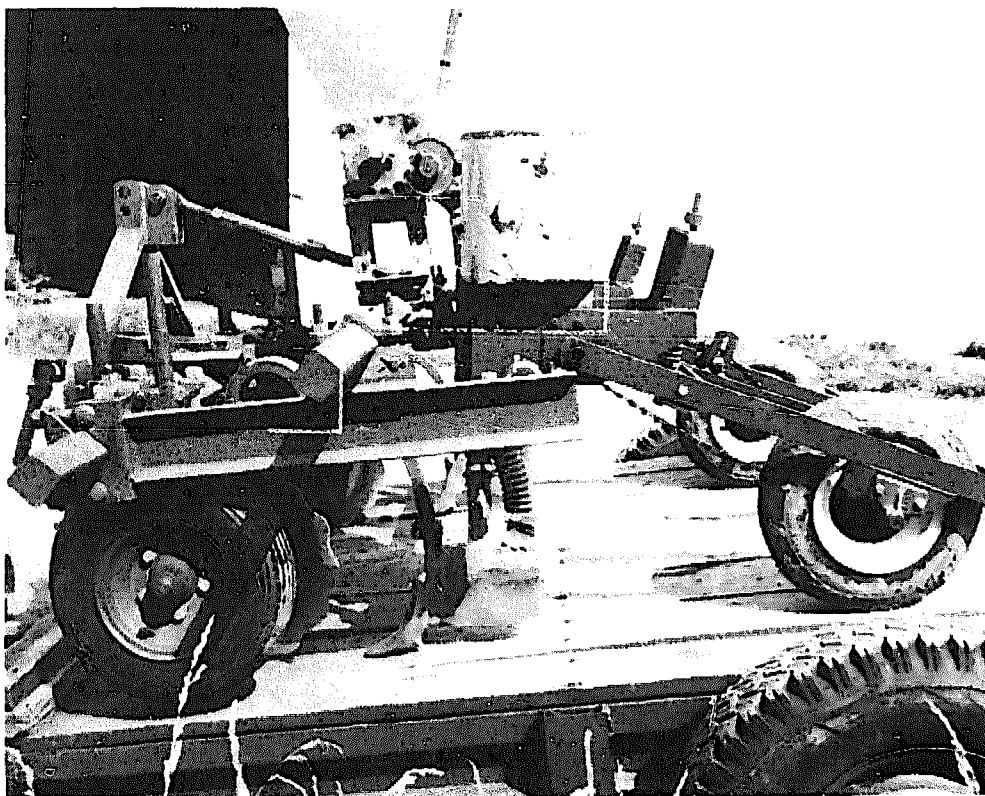

(Photo: U. S. Soil Conservation Service)

Fig. 10-4. A slot planter. This machine leaves crop residue on the surface and disturbs only the soil in the slot in the crop row.

the rows is not disturbed, weeds and grass are at a disadvantage.

Farmers who are trying for optimum yields in the northern part of the corn-growing area should usually avoid planting corn or beans in sod. The soil under sod usually has a lower temperature than that under grain residue, and germination and seedling growth are delayed. Planting in sod seems to work satisfactorily in areas farther south (southern Illinois and the South) where the soil warms a little earlier and the growing season is longer.

U.S.D.A. Leaflet 554, "Mulch Tillage in Modern Farming," suggests that generally it is best to use rotary-type equipment only on sandy and sandy loam soils. It is difficult to operate on stony land. Mounting

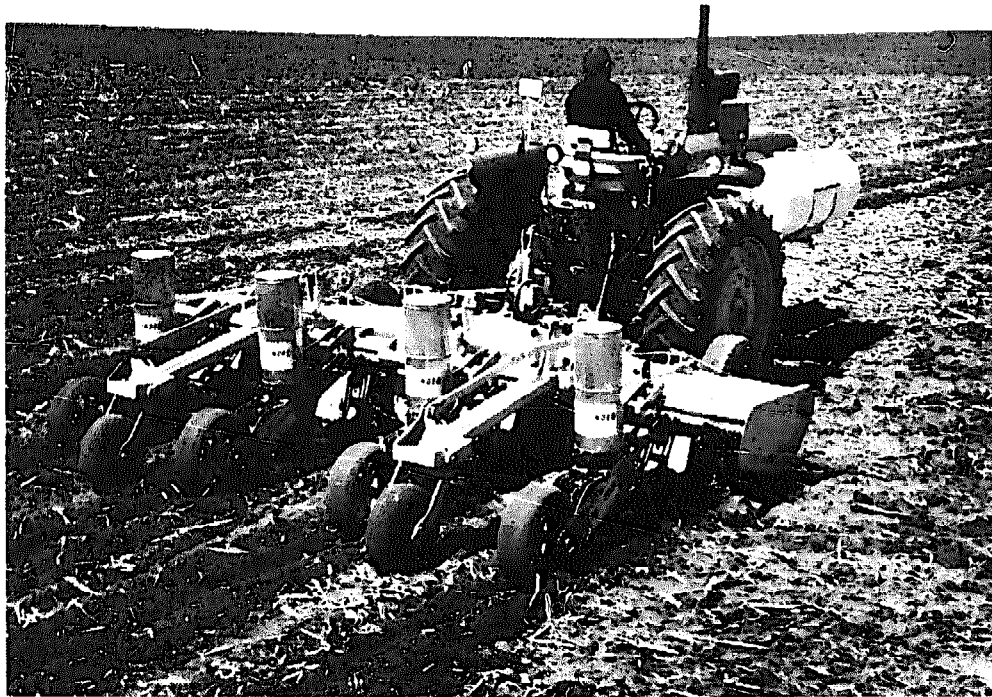

(Photo: U. S. Soil Conservation Service)

Fig. 10-5. A strip-tillage machine in operation. A strip no wider than one-third the distance between rows is disturbed.

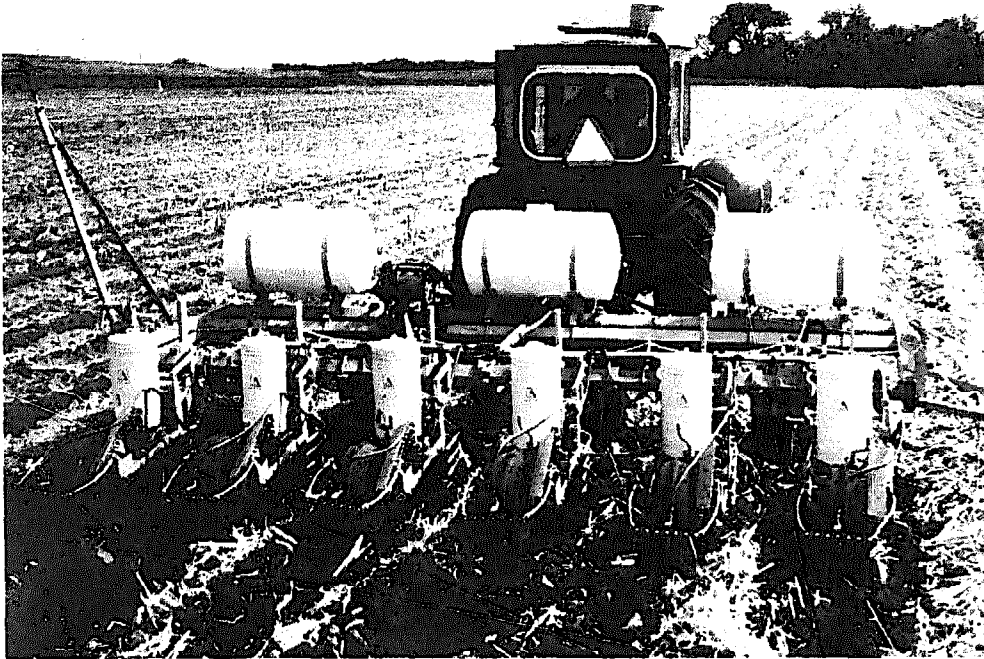

(Photo: U. S. Soil Conservation Service)

Fig. 10-6. A modified no-till planter working in sorghum residue.

of individual tillage and planting units of all types of equipment must be flexible enough to permit riding over stones without stopping or lifting the adjoining units from the ground.

In slot planting, the machine makes a slot in which the seed is planted and leaves the crop residue on the surface. Only the soil in the slot is disturbed. Slot planting is not well suited to clay soils because the slot has a tendency to open when the soil dries. If the soil is dry, it is difficult to close the slot with press wheels and to get good contact between seed and soil.

Strip tillage equipment disturbs a strip no wider than one-third the distance between the rows.

The no-till (or zero-tillage) planter disturbs the soil only in the immediate area of the crop row. In till

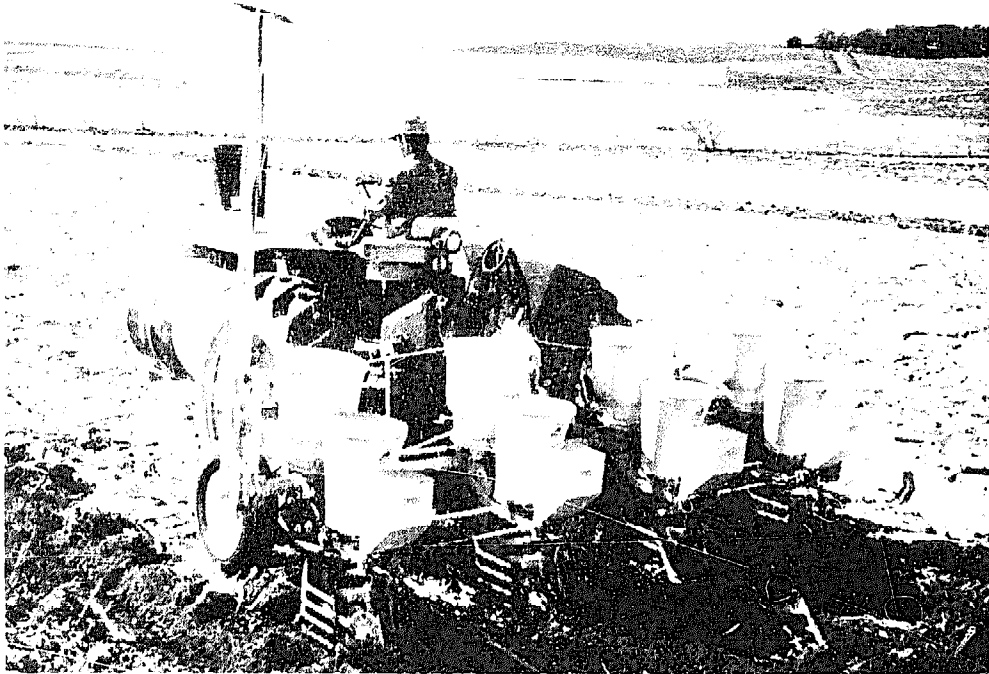

(Photo: U. S. Soil Conservation Service)

Fig. 10-7. A till planter scalps the old crop row, pushing the residue aside and leaving a protective cover between rows.

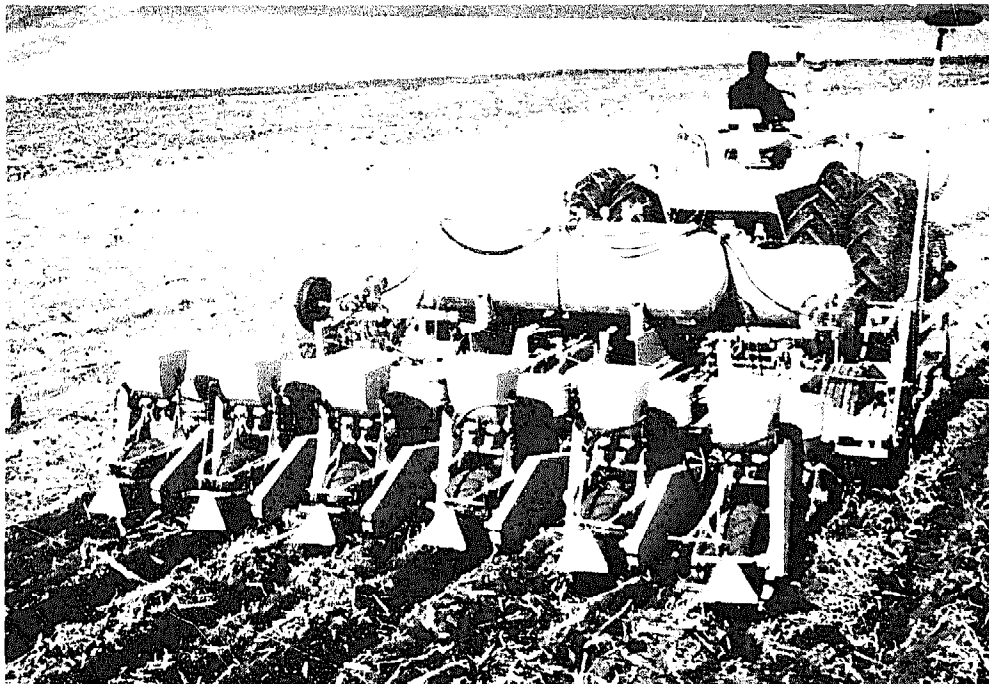

(Photo: U. S. Soil Conservation Service)

Fig. 10-8. Chisel planter planting corn in old corn residue. The soil is not turned and the residue is left on the surface.

planting, the area of the old crop row is scalped and the residue pushed aside, leaving a protective cover between rows.

The chisel planter prepares the seedbed by chiseling without turning the soil, leaving a protective cover of crop residue on the surface.

Handling Crop Residues

The way to handle small-grain residues varies, depending on the crop and the yield. Wheat straw and stubble give the most trouble in planting; the straw is stiff and slow to decay. Rye, barley, and oat straw are easier to handle. Loose straw windrowed on high stubble by a combine also makes planting difficult.



(Photo: U. S. Soil Conservation Service)

Fig. 10-9. Soybeans planted in small grain stubble. The stubble helps prevent lodging of beans and provides excellent erosion control.

Straw-chopper attachments to combines do the best job of putting the straw in good condition for planting. They cut the straw into short pieces and spread it evenly over the ground. Rotary mowers can also be used to shred both straw and stubble. Corn stover should be shredded after the corn is picked. This provides good winter cover that protects the soil from wind and water erosion. You can then mulch plant in the spring.

Other Suggestions

If the land is rough or irregular, or is terraced, and if the equipment is four-row or more, each unit should be on a flexible mount so that it moves up and down individually. Flexible mounting is not so important for two-row units.

Chisel and rotary tillage planting units usually require more power than do other types.

If strip tillage, chisel planting, and till planting equipment is used on sloping land, it is best to plant on the contour. If planting is up and down slope with this type of equipment, there is considerable danger of concentrating water in the tilled area, which can result in serious erosion. If planting must be done up and down slope, it is best to use slot planting, no tillage, or zero tillage equipment. The area tilled is smaller, which reduces the chance of concentrating water on freshly tilled soil.

All of the mulch tillage methods result in less erosion, according to the experiences of farmers and researchers. At Madison, Wisconsin, on a 6 per cent slope, erosion was reduced 77 per cent on third-year corn. Only 45 per cent of the surface was covered by shredded cornstalks and the corn was planted up and down slope. At Coshocton, Ohio, on 9 to 15 per cent slopes, planting corn on the contour and using conventional tillage

resulted in a soil loss of 7.8 tons per acre; the mulch-tilled plots lost only 0.03 ton. In Indiana, on a 5 per cent slope, a chopped hay mulch on a minimum-tilled surface reduced soil loss by 95 per cent. The more complete the mulch cover, the greater the reduction in erosion, runoff, and the moisture evaporation.

Plow Plant

Farmers who prefer to plow their land can reduce the number of times over the field by the plow-plant method—that is, planting corn or other row crop at the same time the ground is plowed or soon after. Plow-plant is best adapted for use on sandy to medium-textured soil in good physical condition. Clods may be so hard on fine-textured soils that effective planting and



(Photo: U. S. Department of Agriculture)

Fig. 10-10. Plow-planting, pre-emergence spraying with herbicide, and fertilizing are being done in one operation.



(Photo: Allis-Chalmers Mfg. Co.)

Fig. 10-11. Four-row wheel track planter in operation after the field has been plowed.

cultivating may be difficult. It may be necessary to use some sort of light, secondary tillage just behind the plow on such soils.

Plow-plant systems work well in the northern states where wet soil delays preparation of land until near planting time, and where the planting season is rainy.

There are several variations of the plow-plant method, all of which allow plowing to be done later than for conventional tillage systems.

1. Plant immediately after plowing. Set the planter to run in the tracks of the tractor pulling the planter. There is no other preplant operation. The pulverizing action of the rubber-tired tractor wheels forms the required firm, pulverized zone around the seed. It is necessary to have a tractor on which the wheels can be set at the same width as the corn planter. (It should be noted here that

the hazard of overturning a tractor on sloping land is greater when the wheels are set in.)

2. Another method is to attach a planter directly behind the plow so that it plants on the side of one of the turned furrows. This plow-plant system was developed at Cornell University Experiment Station, New York. An individual planter unit that can be attached directly behind the plow is needed for this method. This planter requires a depth control runner on the planter shoe to firm the soil and provide uniform depth planting. Two-row cultivation can be difficult if a one-row planter unit is used in the plow-plant system on contoured fields.
3. A third variation is to attach behind the plow a secondary tillage implement such as a spike-tooth harrow, rotary hoe, or cultimulcher. This system plows, smooths, and lightly firms the soil in one operation. The corn should be planted soon after plowing. There is no other seedbed preparation.

Plow-plant systems cut costs by eliminating one or more steps in seedbed fitting. These savings can run as high as \$10 an acre. These systems give better control of soil erosion and water runoff during late spring and early summer because the soil remains loose and has a rough surface. There is also less wind erosion. Plow-plant reduces the possibility of soil compaction or tillage pans.

Because of the rough condition of the soil, weeds may not become a problem until the clods have mellowed and the corn is 6 to 8 inches tall. If weeds are a problem, a tine weeder, rotary hoe, or cultipacker, used for the first weed-control operation, will break up the clods and bury the weeds between the rows.

There are some disadvantages. Plow-plant schemes delay plowing until corn-planting time. This delay may

disrupt the spring work schedule. With large acreages it may be difficult to do the work at the optimum time.

Drought hazards may increase because the growing sod or winter cover crops will use moisture needed by the corn crop.

Planting corn in tractor tracks on fine-textured soil may cause hard crusts in the planting row, especially if the soil is too wet. When the soil is too dry at planting time, seeds may get a poor start because soil particles often are too coarse for good soil-to-seed contact. Using a light soil pulverizer behind the plow will help, but this practice makes the field less resistant to erosion.

Managing Residues to Control Wind and Water Erosion

So far we have talked about planting in residues and in sod. Handling residues during harvesting, seedbed preparation, planting, and cultivating should all be done so as to leave residues of the previous crop on top of the soil until the next crop is seeded. These residues—or stubble—of the last crop make a mulch that helps conserve soil and water. In the Great Plains this is called stubble mulching and it is particularly useful there where ways to control wind erosion are a continuing need and where high-producing stubble crops such as small grain and sorghum are common.

Left on the surface, the plant residues keep the wind from getting at the soil and the rain from compacting it. With residues on the surface, there is less runoff because the soil takes in water more rapidly. There is also less soil washing because the mulch slows down the speed of the water that does run off. And as the residues turn to humus they improve the soil.

In the semi-arid areas use as little tillage as possible,



(Photo: U. S. Soil Conservation Service)

Fig. 10-12. An estimated 12 to 13 tons per acre, green weight, of shredded sorghum residue left on the surface for soil protection and improvement.

so long as you control the weeds. Research in several experiment stations in the Great Plains shows that you destroy about half of whatever residues are left each time you use a disk-type implement. Sweeps or blades destroy only about one-tenth of the residue each time over the field.

Sweep-type implements are best because they cover less of the residues and loosen the soil below the residue thereby killing weeds. The wider the better, but not less than 30 inches is a good rule for the width of sweeps. To control weeds and conserve moisture sweeps or blades should be run 3 or 4 inches deep most of the time. But you need to cultivate deeper than this, 5 or 6 inches, at least once during the year to help prevent the formation of a tillage pan.

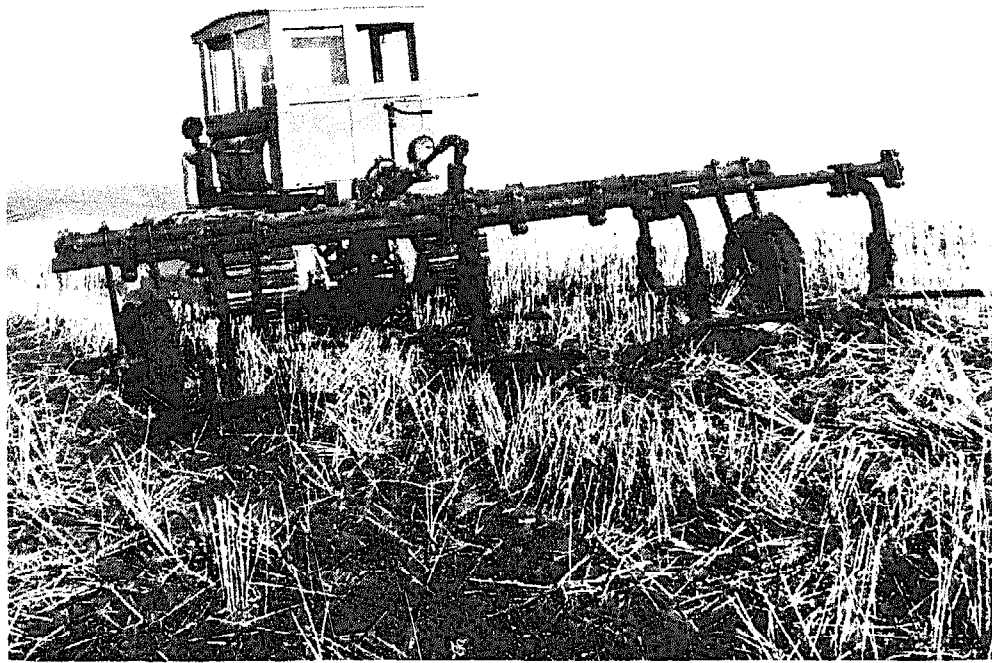

(Photo: U. S. Soil Conservation Service)

Fig. 10-13. Tool equipped with seven 30-inch sweeps for stubble-mulch tillage that leaves the residue on the surface.

Stubble-mulching is more necessary on summer-fallowed land. Because of the long time between crops, a cover of residue is especially needed. If possible, leave the stubble standing after harvest until the next spring. If there is much volunteer grain or weeds it may be necessary to cultivate with a sweep or blade soon after harvest or later on in the fall.

In the humid areas residues of corn and small grain help stop the impact of rain drops thus preventing splash erosion. Many farmers formerly were reluctant to save their corn stalks because bacteria that cause their decay used up so much of the soil nitrogen that yields were hurt. But by using high nitrogen fertilizers this objection is overcome.

Chapter

XI

LAYING OUT AND CONSTRUCTING PONDS

Farm ponds constitute an important soil conservation practice. They provide water for livestock, for irrigation, spraying, fire protection and gully control. On many farms a pond built on a back field makes it possible to use the hard-to-get-to field for rotation pasture, thus putting to productive use and protecting with conserving crops a field that may have been neglected otherwise. The pond and its immediate surroundings also make an excellent wildlife habitat.

Designing a farm pond is a technical job requiring knowledge of soils, rainfall, watershed characteristics, water movement and other information in addition to experience in applying this information at a given site. Since no two pond sites are exactly alike, each pond must be tailored to fit the site where it is to be built. The soil type, size and shape of the watershed, topography, climate, etc., will vary from place to place.

This means that the instructions for designing and building a pond must consist of principles and their application to specific conditions. It is not possible to give recommendations for all the varied conditions through-

TABLE 11-1. Pond capacities and livestock water requirements.

Depth of Pond to Spillway (in feet)	Diameter at Spillway Level (in feet)	Diameter at Bottom of Pond (in feet)	Approx. Capacity of Pond (in gallons)	Water Available for Livestock Allowing 50% Loss in Seepage and Evaporation	No. of Cow Equivalents* That Can Be Watered from Pond for 120 Days Without Rain	No. of Acres in Drainage Area Required to Fill Pond in 12 Months If in Drought Year
8	57	9	60,000	30,000	36	2
8	73	25	120,000	60,000	71	3
10	91	31	240,000	120,000	143	4
10	119	59	480,000	240,000	286	8
12	116	44	480,000	240,000	595	8
14	149	65	1,000,000	500,000	1190	17
10	213	153	2,000,000	1,000,000	2380	34
18	188	80	2,000,000	1,000,000	2380	34

*Cow equivalent is calculated by counting 1 horse, 6 hogs, 6 sheep or 100 hens as consuming the same amount of water per day as one cow.

(From Missouri Circular 482)

out the country. Those given are as specific as they can be under the circumstances.

As with many other soil conservation practices, the advice of a competent engineer, familiar with local conditions, should be sought.

One of the first decisions to make is the size of pond needed. It should be large enough to furnish water for all the purposes for which it is built for a period of 18 months without appreciable runoff.

Evaporation and seepage probably take more from the pond than do livestock. This depends on the location, the climate and other factors. But it cannot be overemphasized that the pond should store a large amount of water as compared to what needed.

The amount of water needed by various kinds of livestock may be determined from Table 11-1, taken from Missouri Circular 482. After calculating the approximate amount of water needed for livestock a study then should be made of the sites where ponds can be built. If site characteristics are such that one pond does not meet these needs, then a second pond may be needed. In general, according to U.S.D.A. Leaflet 259, a pond should be at least six feet deep and at least one-fourth acre in surface area. If fish are to be stocked, it should be deeper. See Chapter XVII. Figure 11-1 shows recommended depth of reservoirs in various parts of the United States.

A Suggested List of Activities Involving Approved Practices

1. Selecting the Pond Site
2. Locating the Pond
3. Surveying the Watershed
4. The Spillway
5. Using Pipe Spillways
6. Preparing the Site

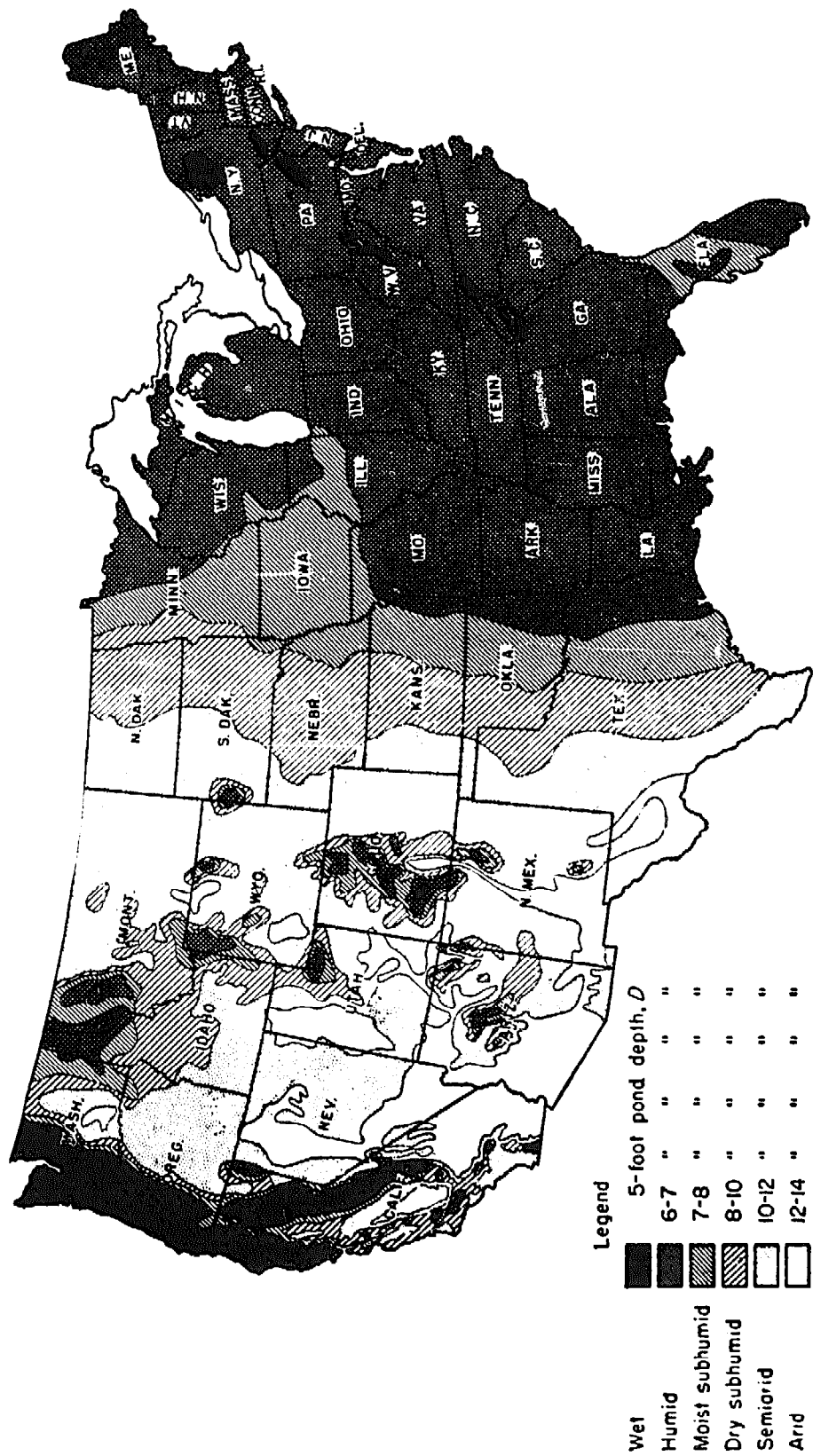

Fig. 11-1. Recommended minimum depth of reservoirs. (From U.S.D.A. Agriculture Handbook 387)

7. Building the Core Wall
8. Constructing the Fill
9. Building Excavated Ponds
10. Sealing Ponds

1. Selecting the Pond Site

One of the first considerations is the nature of the soil. Many ponds fail because they are built on the wrong kind of soil. Avoid sites for the fill where there is shallow soil cover to shattered rock, sand or gravel. The best soil is deep clay or sandy clay. Such soils are slowly permeable and will, therefore, hold water. Avoid sites with rock out-cropping along the bank or with rock or shale ledges near the surface. Also, avoid sites having sand, gravel, peat or marl through which the water might seep.

The watershed above the pond should be large enough to keep water in the pond during dry periods, yet not so large as to require a large and expensive outlet structure to carry off excess water safely. A general guide for use in estimating the approximate size of drainage area required for a desired storage capacity is shown in Figure 11-2. For example, in western Tennessee, from 2 to 3 acres of watershed area are needed to impound 1 acre-foot of water. In eastern Kansas, from 12 to 20 acres are required. A proper relationship between pond area and watershed area is desirable. A general rule to use is one acre of pond area for not less than 6, nor more than 20 acres of watershed area. Where the ratio is less than 1 to 6 there may be difficulty in keeping the pond filled during dry weather. Where the ratio is more than 1 to 20, the water disposal problem will be complicated and expensive because of high spillway costs. Also, there will be increased danger of siltation.

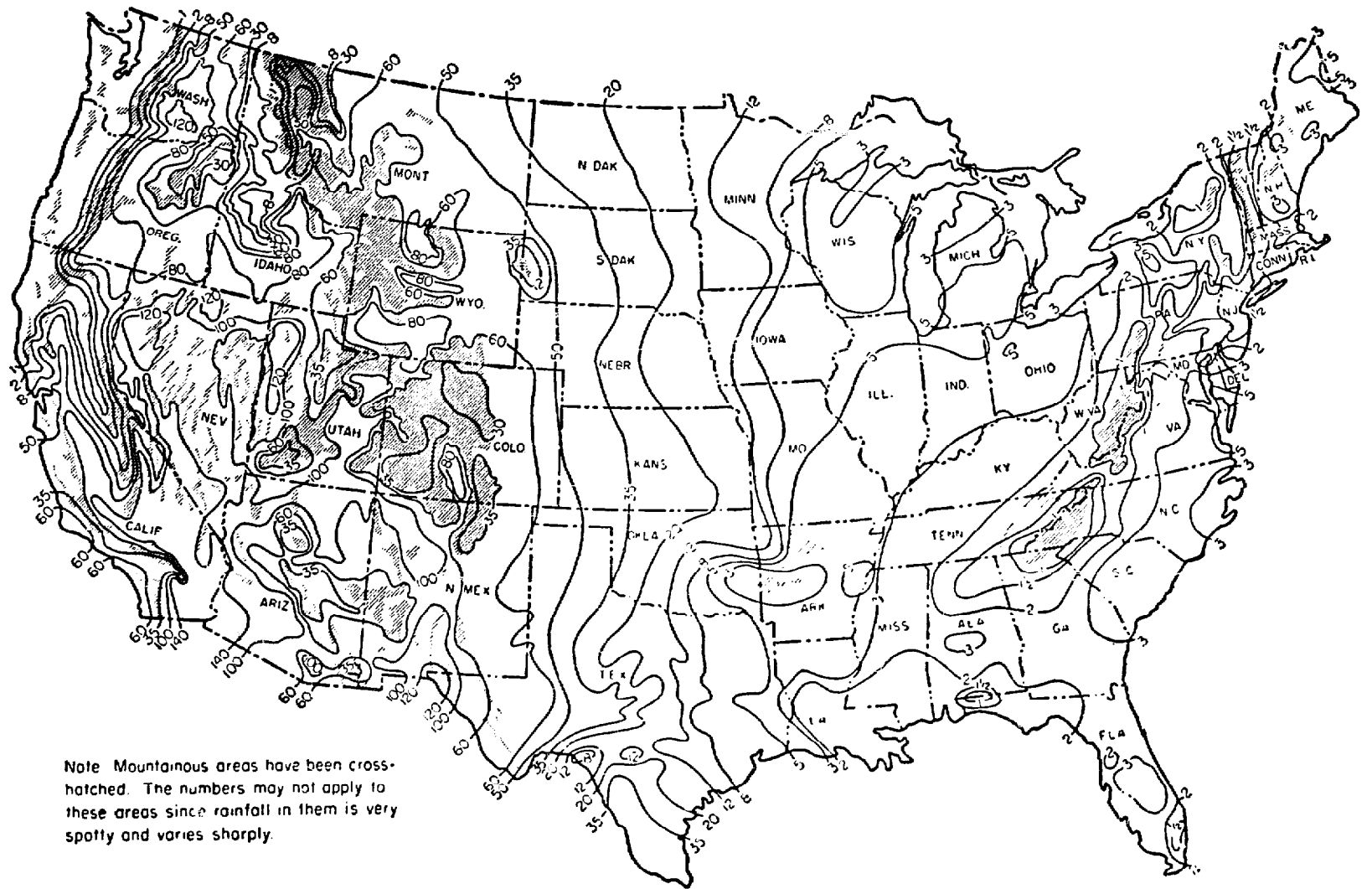

(From U.S.D.A. Agriculture Handbook 387)

Fig. 11-2. A general guide for use in estimating the approximate size of drainage area required for a desired storage capacity in reservoirs. The numbers on the chart show the number of acres of drainage area required for 1 acre-foot of water impounded.

To avoid excessive silting, which results in loss of capacity, the watershed should have a high per cent of vegetative cover. An ideal condition is one where the entire watershed is in grass. If this is not possible, the area should be protected by terracing, strip cropping or other such measures along with a good crop rotation. It is best to avoid any plan that would divert water from neighboring farms.

2. Locating the Pond

There are many advantages to locating the pond near the farm buildings. However, drainage from the barnyard should be avoided for sanitary reasons. There is also an advantage to locating the pond on a remote part of the farm in order to provide water for stock on an isolated pasture.

Exposure of the pond area to the prevailing winds should be considered. Effort should be made to locate the pond so that the prevailing wave action is away from the fill.

Build Small Dam

Everything else being equal, the best location for the pond will naturally be the one that permits the maximum amount of storage with the least amount of fill. Generally this is where the smallest dam can be placed to form a pond of the desired size. A draw between two hills or a large gully are good examples.

3. Surveying the Watershed

On land where the topography is clearly defined the watershed for the pond can be outlined tentatively on an aerial photograph by studying the photo and noting carefully the drainage patterns. Somewhere between

the points at the heads of draws and ditches will be the ridge or divide. Available soil survey maps will help. If U. S. Geological Survey maps are available for the area they will be of considerable help since they show contour lines.

After outlining the watershed the acreage should be measured. The average per cent of slope, the nature of the soil, and the vegetation and land use should be noted. This information will help in estimating the amount of runoff to be expected. For figuring ponds the runoff rate is not as important as the total runoff.

Survey Pond Site

There is no one set of instructions that will fit all locations and conditions for staking out farm ponds. At the same time there is no substitute for having a complete understanding plus a sketch of how the dam and the finished pond will look.

After the location of the pond has been selected, it is important to inspect the gully below the proposed pond to determine if it is still active and therefore likely to eat back into the fill. Where a concrete apron type of outlet is used, the grade below the pond must be stable. The gully should be examined for at least 500 feet below the pond. By taking readings with a level in the bottom of the gully the exact grade can be determined. Ordinarily a grade of not over .5 per cent (one-half foot fall in each 100 feet) will be safe but this will depend on local conditions. If the gully is raw and there are occasional overfalls it is very likely that it is still cutting. In this case a propped outlet can be used. A propped outlet is one where the outlet pipe extends out beyond a support and lets the water fall into the gully. See Fig. 11-9.

Experience has shown that a well-designed pond, fitted to the watershed, will impound enough water so

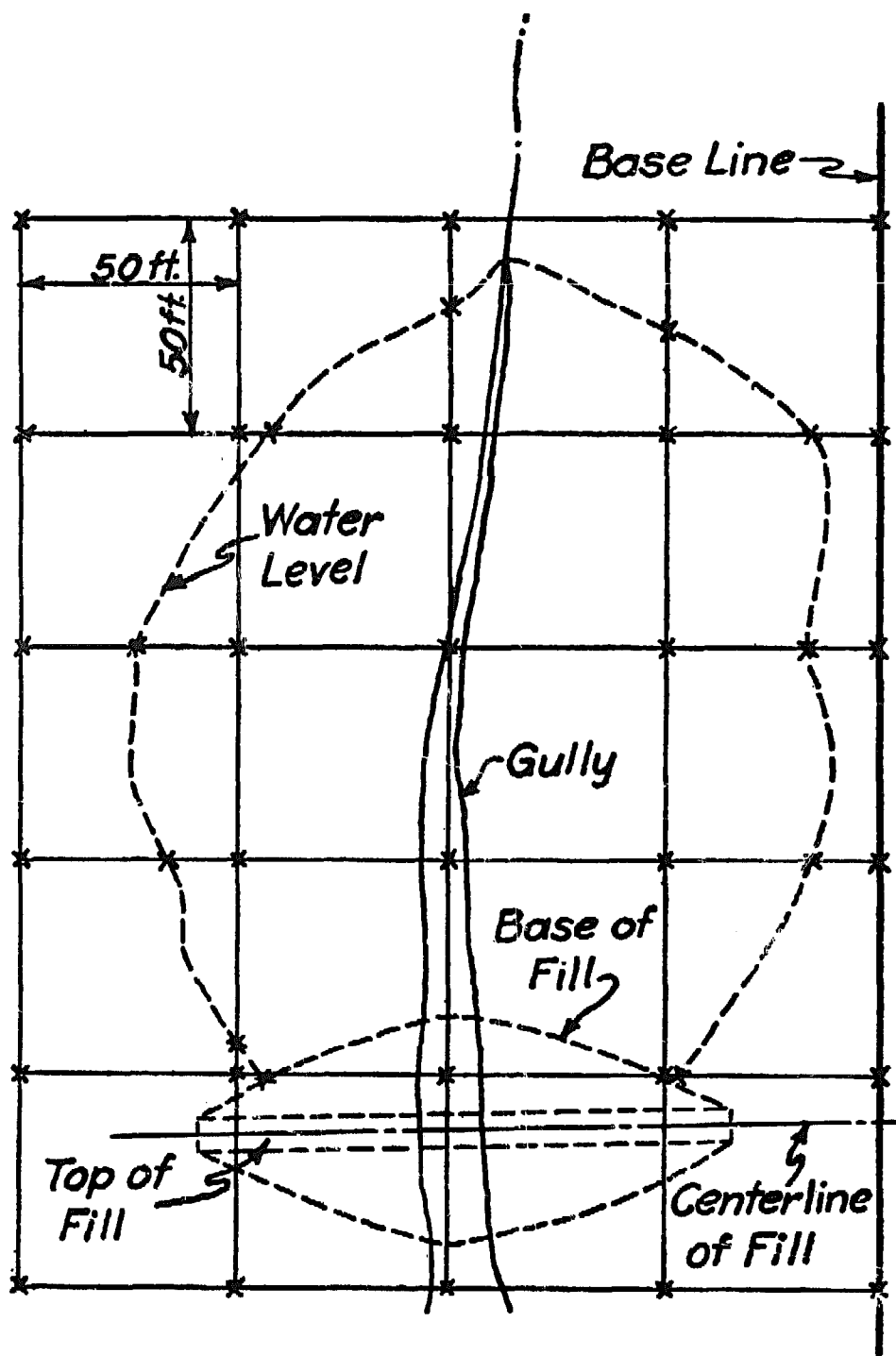

(Drawing: U. S. Soil Conservation Service)

Fig. 11-3. A simple grid on which to plot the pond. Plotted to a predetermined scale, the surface area of the pond as well as other measurements can be made. If the stakes are 50 feet apart, each square then covers 2500 square feet.

that the peak rate of flow below the pond will be considerably less during storms than before the pond was built. This means that in some cases an active gully has actually been healed (below the pond) simply because the rate of flow leaving the pond is low compared to that entering it. But you should check with local technicians who have had experience with ponds in local conditions. It is better to be safe by making a conservative design.

Since it is important to know the area of the pond surface when the pond is finished and full of water, some means should be used in surveying the pond site that will give this information. A simple method that does not require the use of a surveyor's transit is a modification of the grid system using a base line from which every point is measured (Fig. 11-3).

Stake Out Base Line

With this method the first step is to lay out a straight line approximately parallel to the gully in which the pond is being constructed and at right angles to the fill. This line can be made straight by sighting along the line of stakes. This base line should be laid out to one side of the pond area so that it will not touch the pond or the fill. It should be close enough to allow for convenient measurements since all points will be tied into this line.

Next, set rows of stakes at right angles to those in the base line. These rows of stakes should extend far enough so that the pond and fill will be laid out within the area staked. These stakes must be set at exact intervals—every 50 feet, for example—and should be plotted on a map to a predetermined scale such as 1 inch to 50 feet.

In order to be sure that you are making an exact right angle from the base line without using a transit,

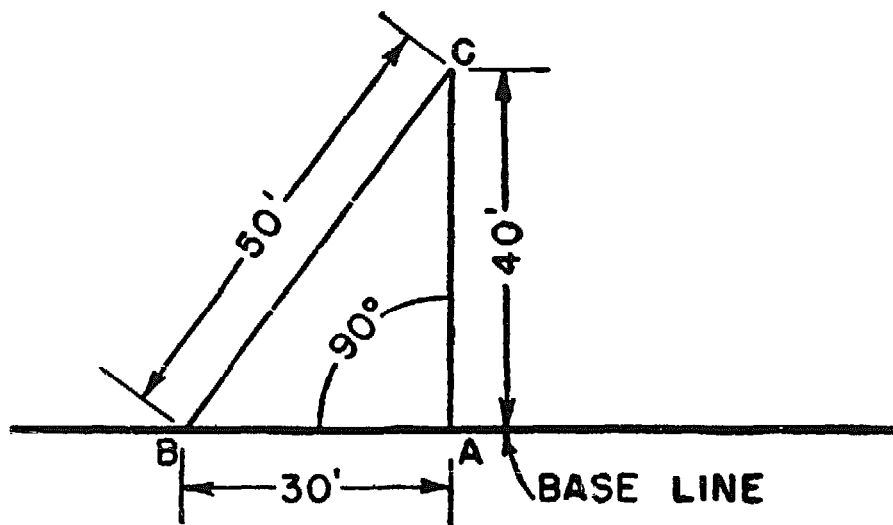

(From U.S.D.A. Handbook No. 135)

Fig. 11-4. "3-4-5" method of laying out a right angle. This simple procedure makes it unnecessary to use a transit and is satisfactory on many jobs.

the rule of 3, 4, and 5 may be used (Fig. 11-4). From one stake in the base line measure 3 feet along the base line and set a stake. Then measure 4 feet from the first stake at what you think is a right angle to the line and set another stake. You now have three stakes set in a right angle triangle. The distance between the second stake you set in the line and the one set at right angle to it should be 5 feet. If it is not, then move it until it is, but make sure that it is still 4 feet out from the first stake. This is making use of the rule that the hypotenuse of a right angled triangle is equal to the square root of the sums of the squares of the two sides. To be more accurate you could use 30-, 40-, and 50-foot measurements.

Additional rows of stakes, 50 feet apart at right angles to the base line should be set. Make a map with a mark at each stake, one inch apart, and draw lines vertically and horizontally between them. You now have a grid on which to plot the pond.

By taking readings for elevation at each of these

stakes and plotting each row on graph paper, it is possible to determine a proper balance between the amount of earth needed in the fill and the earth to be moved. Plotting the elevations along each horizontal line on the grid will show the high and low places and by knowing where earth is to be moved, the cost of the pond can be kept at a minimum.

The fill site should be staked out next (Fig. 11-5). A

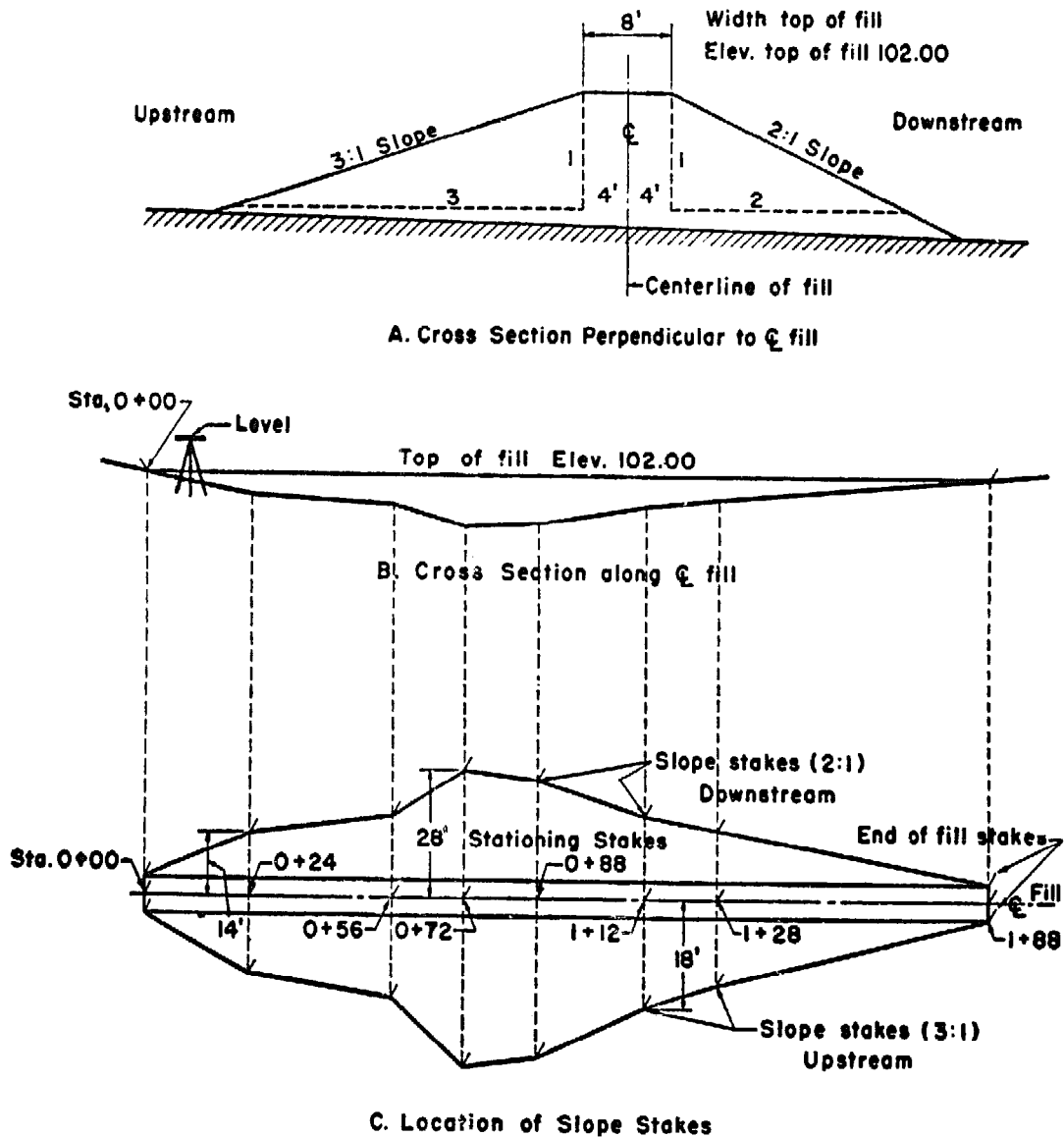

(From U.S.D.A. Handbook No. 135)

Fig. 11-5. Method of setting slope stakes.

level, rod, and tape will be needed for this job. A stake marking the highest point where the fill will join the bank should be set. Another stake at the same elevation on the opposite bank will indicate the other end of the fill. The line between these stakes is the centerline of the fill.

Assuming that the top of the fill is to be 8 feet wide, (it should be wider if heavy equipment is to be used and may be less if small equipment is used), set a stake on each side and at right angles to each centerline stake at a distance of 4 feet, one-half the top width. These stakes mark the top width of the fill and serve as slope stakes at this point.

Now temporary stakes should be set along the centerline of the fill at obvious breaks in ground slope. In order to stake out the base of the dam it is necessary to know what the height of the fill will be. This can be determined by reading elevations on these temporary stakes on the centerline. The difference between the reading on these stakes and on the stakes at the end of the fill is the settled height of the fill at those points.

The fill should have a slope of 3 to 1 (3 feet horizontal for each 1 foot vertical) on the upstream side and not steeper than 2 to 1 on the downstream side for most conditions. In silty soils such as deep loess more gentle slopes are needed. To stake out the edge of the fill on the upstream side, for every foot of height at any given point in the centerline move horizontally 3 feet, add four feet and set a stake (slope stake). (The four feet is to allow for half the top width of the fill.) Allowance must be made, however, for ground slope. Since you are working on the upstream side of the fill, the ground will probably be higher at the stake you have just set than at the centerline. Therefore, move back toward the centerline until you find a point where the difference in elevation between that point

and the fill height at the centerline times 3 plus 4 equals the distance from the centerline to the stake. This is the edge of the fill at that point. Repeat this procedure at each of the temporary centerline stakes.

The same procedure will be followed on the downstream side except that since the fill slope is to be 2 to 1, for every foot of fill height you will move horizontally 2 feet and add 4 for top width. Also, since you are now working on the downstream side of the fill, the ground will be sloping away from the fill. So after finding the point just described, you will move downstream and take a reading of the elevation until you find a point where the difference in elevation between that point and the fill height at the center line times 2 plus 4 equals the distance to the centerline.

The drawing in Figure 11-6 should help to illustrate this procedure. Assume that at one of the temporary centerline stakes you find that a fill of 10 feet will be needed. Using the method just described you would

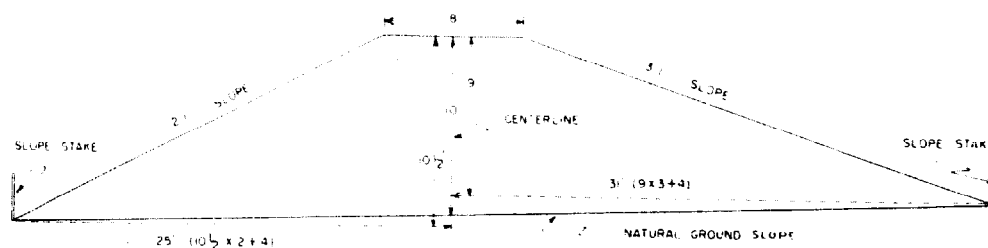

(Drawing: U. S. Soil Conservation Service)

Fig. 11-6. Illustration of method of locating the base of the pond fill.

multiply 10 times 3 and add 4 to locate the fill stake on the upstream side. This would give 34 feet. However, the elevation at this point is 1 foot higher than at the centerline stake. Subtract 1 from 10 leaving 9. Nine times 3 plus 4 gives 31, the distance in feet from the centerline stake to the slope stake.

On the downstream side of the fill (using 2 to 1

slope for the back of the fill) you would multiply 10 times 2 and add 4 giving 24 feet as the distance to the slope stake. However, after checking the elevation of this point, you find that it is 6 inches lower than at the centerline. Add 6 inches to the 10 feet fill height at the centerline. Then $10\frac{1}{2}$ times 2 plus 4 gives 25 feet, the correct distance from the centerline to the slope stake.

Repeat this procedure at each of the centerline stakes. You have now staked out the boundaries of the pond fill.

This is a cut-and-try method but will work and a little practice will develop judgment in how to make these distance adjustments so that a minimum of time will be needed in locating the slope stakes.

4. The Spillway

The kind of spillway to be used will depend on the size of the watershed and site conditions. Generally, in the humid regions watersheds from 10 to 30 acres will require a combination of mechanical and vegetative spillways. These limits will vary, naturally, with the rainfall throughout the country as indicated by Fig. 11-2. Check with local technicians for the limits you should use.

A mechanical spillway is desirable on ponds with considerable drainage area because it eliminates a prolonged trickle flow over the sod spillway which might be harmful to the sod. The mechanical spillway is set lower than the vegetative spillway, and draws enough water out of the pond during and just after storms so that a certain amount of spillway storage capacity is available for handling the next storm. Also, where ponds are fed by springs, the small amount of water is drained off, thus preventing damage to the sod. The difference in elevation between the mechanical spillway

and the vegetative spillway should not be less than one foot and not more than three or four feet.

To design the vegetative spillway you will need to calculate the expected rate of runoff in cubic feet per second (cfs) for the watershed, as explained in Chapter IV, using a 10-year frequency rain. Then design the vegetative spillway as you would a grassed waterway, (Chapter V) to carry this amount of runoff. It is best to plan for a flow not deeper than 9 inches (3 inches if the pond is to be used for fish production.)

The vegetative spillway is usually wider where the water enters than the channel itself. After the water passes the entrance it will usually flow faster because of the grade. Hence the need for more width at the entrance. The proper width of the entrance can be determined as follows:

For entrance flow 9 inches deep, $L = 0.56Q$

For entrance flow 6 inches deep, $L = 1.03Q$

For entrance flow 3 inches deep, $L = 2.92Q$

(L is the bottom width of the opening and Q the cubic feet per second of runoff expected.)

The opening should taper gradually to the channel width.

This method of designing vegetative spillways for ponds has proved successful in the Midwest. Local variations may be needed.

The spillway should be about 2½ feet below the top of the fill after it has settled. This allows for plenty of freeboard to protect the fill during storms.

Construct the vegetative spillway in such a way that it carries water to a safe channel below the dam. This means that it should be built on a gentle slope, probably not over 3 per cent, and the outlet should be flared so that the water is spread over as wide an area as possible when it is discharged. Where slopes in the spillway must exceed 3 per cent, the width of the

channel may also be increased to spread the water and decrease the possibility of damage. These conditions should be met, or approached as nearly as possible. Otherwise the site is not suitable for a pond. The sides of the channel should have a slope of 4 to 1.

The pipe or mechanical spillway must be lower than the side or vegetative spillway. This provides that the surplus runoff will be handled first by flow through the small pipe. Then as the water accumulates in the pond faster than can be handled by the pipe during periods of heavy runoff, the sod spillway goes into action. The proportionate amounts handled by each will be determined by the duration and character of the rainstorm.

The distance, in height, between the bottom of the side spillway and the inlet of the pipe spillway is shown as "S" in Figure 11-7. This distance determines the

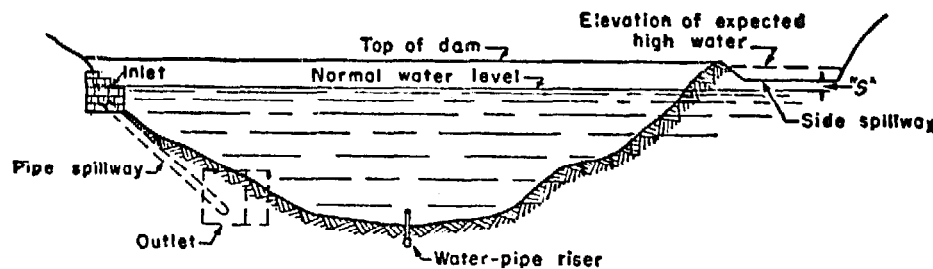

(From U.S.D.A. Leaflet 259)

Fig. 11-7. Profile through axis of dam, showing the relative elevations of the side spillway, pipe spillway, and top of dam.

runoff that will collect as temporary storage and pass through the pipe. For all practical purposes, the difference in elevation "S" in feet between the pipe inlet and the sod spillway may be determined by dividing the watershed area in acres by the surface area of the pond in acres, and then dividing the result by 6. For example, if a watershed area is 20 acres and the surface pond area is 2 acres, the stage "S" will be 20

divided by 2 divided by 6 which gives 1.66, or 1 foot and 8 inches.

5. Using Pipe Spillways

The design and construction of the pipe spillway including the inlet and outlet structure is a technical job. Figures 11-8 and 11-9 illustrate inlet and outlet structures. However, the specifications for building them as well as for installing the pipe between them are not covered here. These instructions may be studied by advanced students who wish to pursue this work further

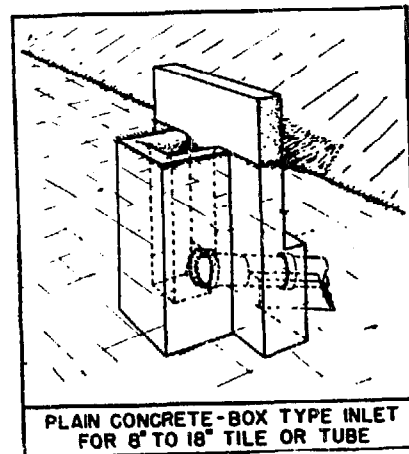
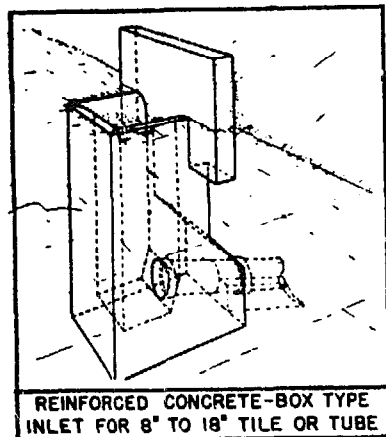
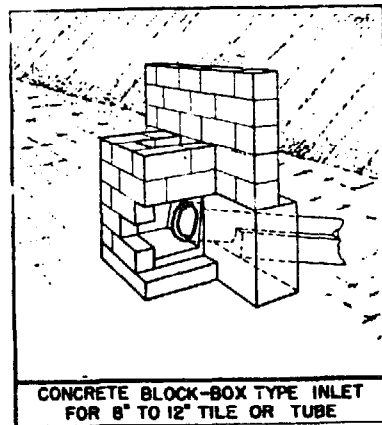

Fig. 11-8. Three types of inlet structures for farm ponds. For detailed specifications see U. S. D. A. Handbook No. 135, ENGINEERING HANDBOOK FOR SOIL CONSERVATIONISTS IN THE CORN BELT.

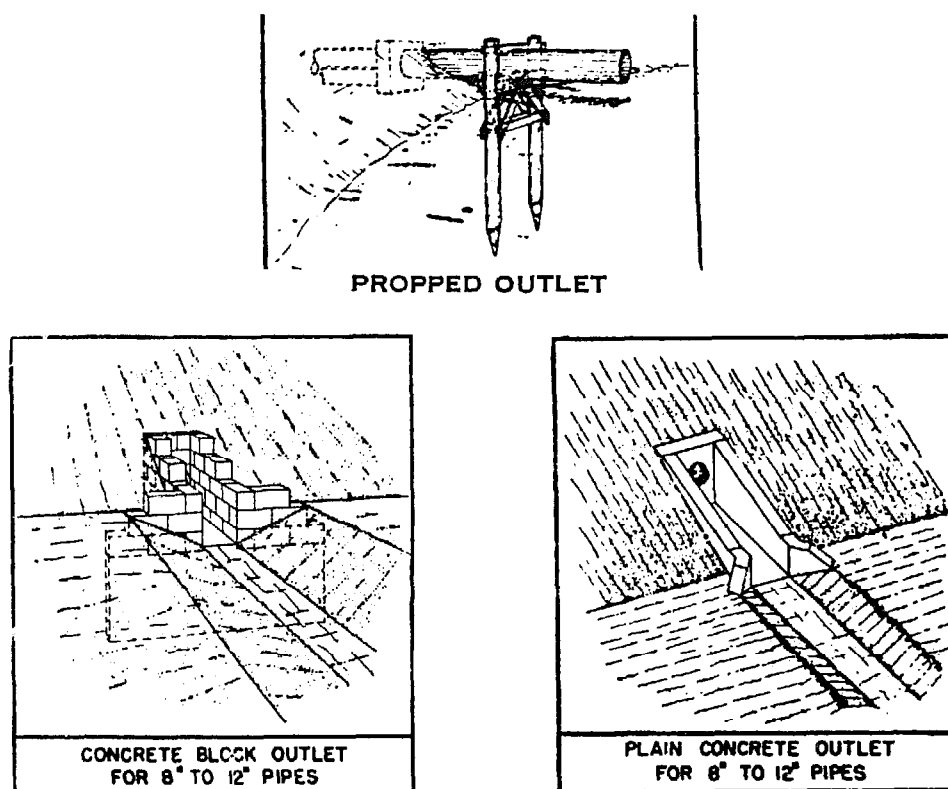

Fig. 11-9. Three types of outlet structures for farm ponds. For detailed specifications see U. S. D. A. Handbook No. 135, ENGINEERING HANDBOOK FOR SOIL CONSERVATIONISTS IN THE CORN BELT.

by referring to U.S.D.A. Handbook No. 135, ENGINEERING HANDBOOK FOR SOIL CONSERVATIONISTS IN THE CORN BELT.

The pipe spillway can be placed in a trench cut in the solid earth along the side of the fill. It should have a box at the inlet to act as a catch basin. This inlet can be made of reinforced concrete or of concrete blocks.

The size of the pipe spillway may be calculated in different ways. One suggestion from U.S.D.A. Circular 259 is as follows:

By allowing the proper vertical distance ("S") between the pipe spillway and the side spillway, the following sizes for spillways should give satisfactory results:

Watershed area	Diameter of pipe spillway Inches	Bottom width of side spillway Feet
10 acres.....	6	8 to 10
10 to 20 acres.....	8	10 to 15
20 to 30 acres.....	10	15 to 20

Increase the bottom of the side spillway 1 foot for each 2-acre increase in watersheds greater than 10 acres.

These dimensions will, naturally, vary with rainfall and runoff conditions in various parts of the country and like many other conservation measures should be checked with conservation technicians who know local conditions.

The depth of the catch basin should not be less than four times the inside diameter of the pipe (Fig 11-8). The cross-section area must not be less than two times the area of the pipe. A suitable headwall should be provided so that a whirlpool will not develop because this reduces the flow materially by letting air into the pipe.

The spillway pipe may consist of vitrified sewer pipe, concrete sewer pipe, or pipe of cast iron or steel.

The outlet end of the spillway pipe and the toe of the earth fill must be protected against erosion (Fig. 11-9). To assure this protection, the pipe outlet should extend several feet beyond the toe of the fill. By this means water can be discharged without too much danger of erosion damage to the fill. A hole may be eroded at the outlet of the timber supported propped outlet, but if the draw is well sodded, the erosion should be localized and not serious. Where short length vitrified clay or concrete sewer pipe is used, it is very important that a section of metal pipe be used at the outlet. If this is

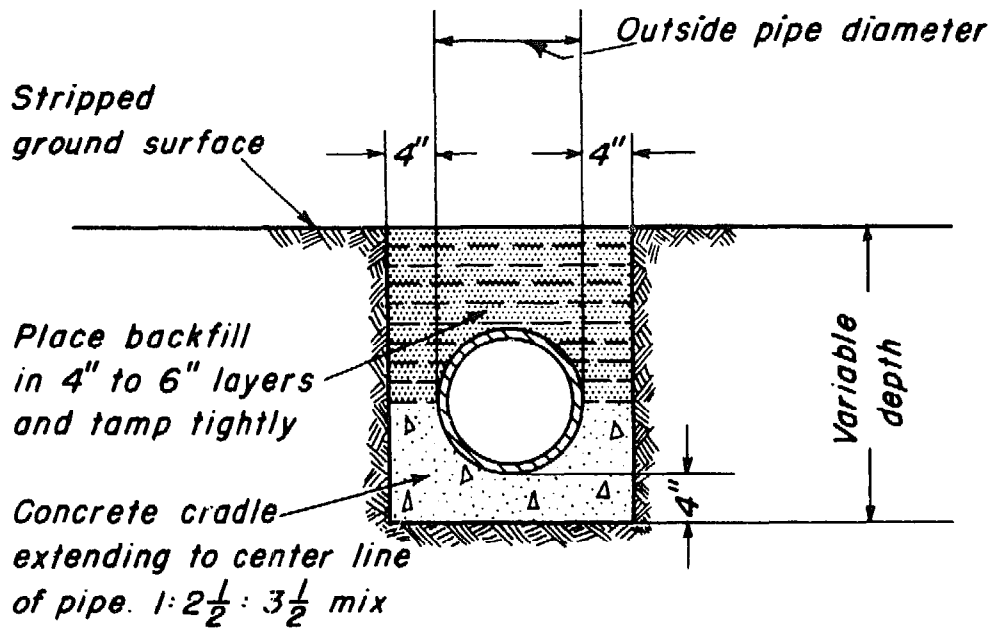

(Drawing: U. S. Soil Conservation Service)

Fig. 11-10. Concrete cradle for use with vitrified or concrete pipe.

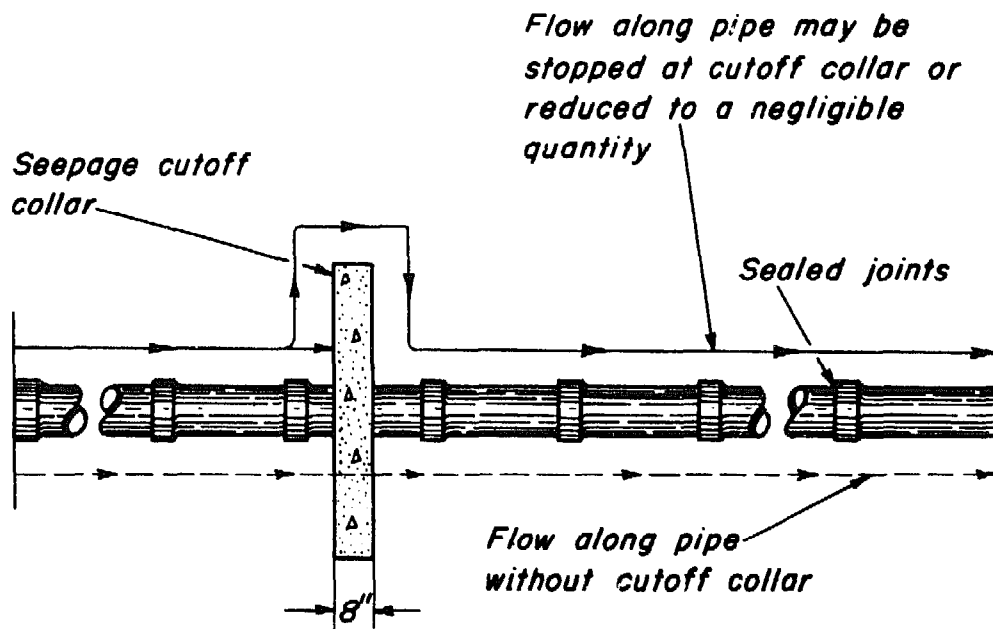

(Drawing: U. S. Soil Conservation Service)

Fig. 11-11. Sketch showing how path of seepage water is stopped or retarded by cutoff collar.

not done, the short lengths of pipe will be undermined and one by one will drop into the eroded hole which will then work back into the dam. A stone or concrete outlet with a concrete apron may be built at the outlet.

The concrete or clay pipe between the inlet and the outlet should be installed in a concrete cradle (Fig. 11-10).

Also, there should be installed concrete cut-off collars every 20 to 40 feet to prevent seepage of water along the pipe, which will eventually cause failure (Fig. 11-11).

Install the pipe spillway before starting to build the fill.

Water Pipe for Tank

A galvanized pipe with a diameter of not less than $1\frac{1}{4}$ inches is needed to carry water from the pond to a tank below the fill. A shut-off valve should be provided at a convenient location below the toe of the dam. At the intake end the pipe should be turned to a vertical position and perforated with $\frac{1}{4}$ -inch holes. The vertical part of the pipe should be encased in a suitable filter such as an oil drum filled with coarse gravel or loose rock.

Figure 11-12 shows a complete farm pond layout.

6. Preparing the Site

The first step in constructing a pond is to remove all trees, stumps, brush, large stones and other objects from the dam site. At the same time, clear the area to be covered by water, including ground at least 10 feet back from the shoreline. Next, remove the topsoil from the dam site, down to a good firm foundation. This fertile soil may later be used in covering the face of the

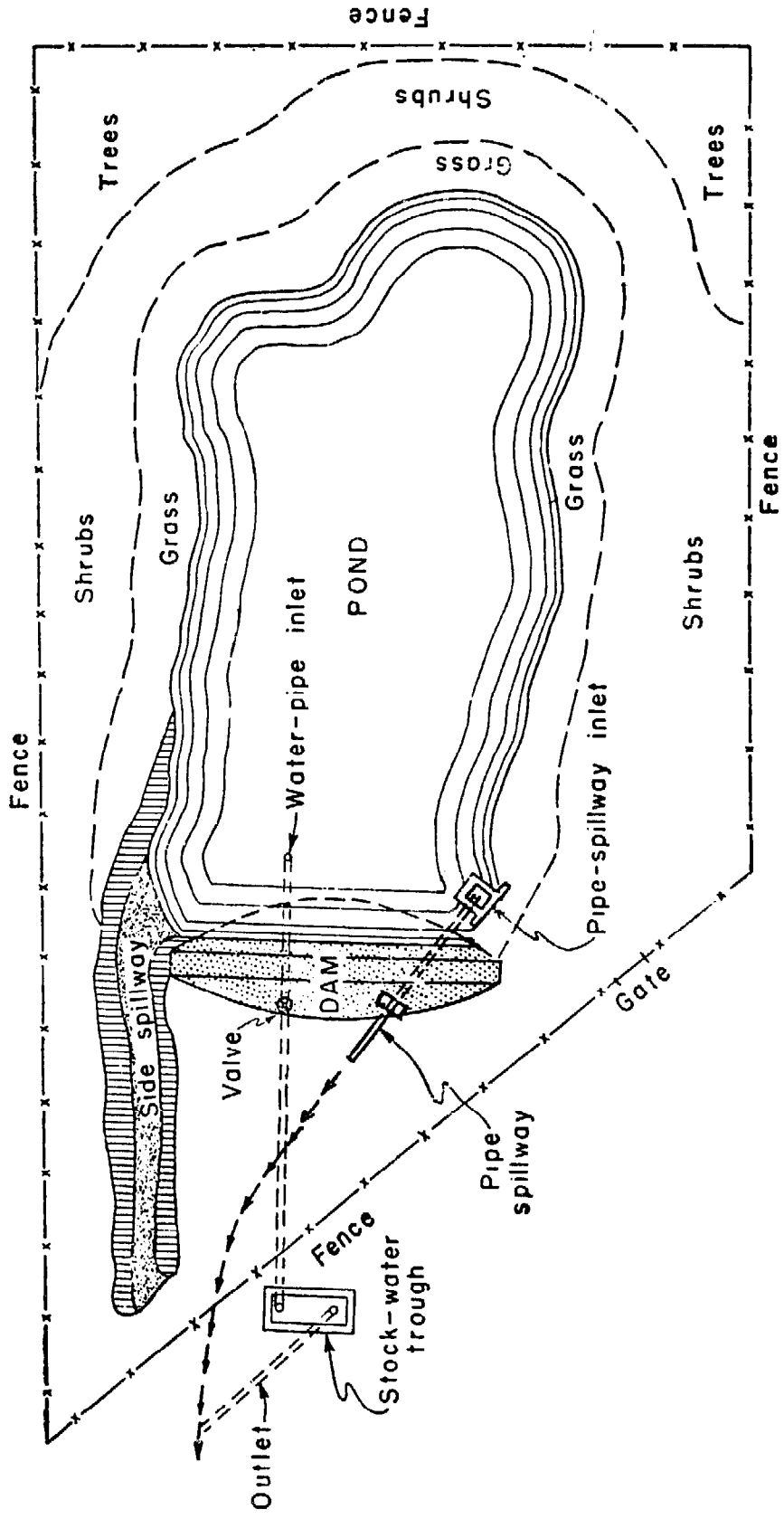

(From U.S.D.A. Leaflet 259)

Fig. 11-12. Illustration of farm pond layout.

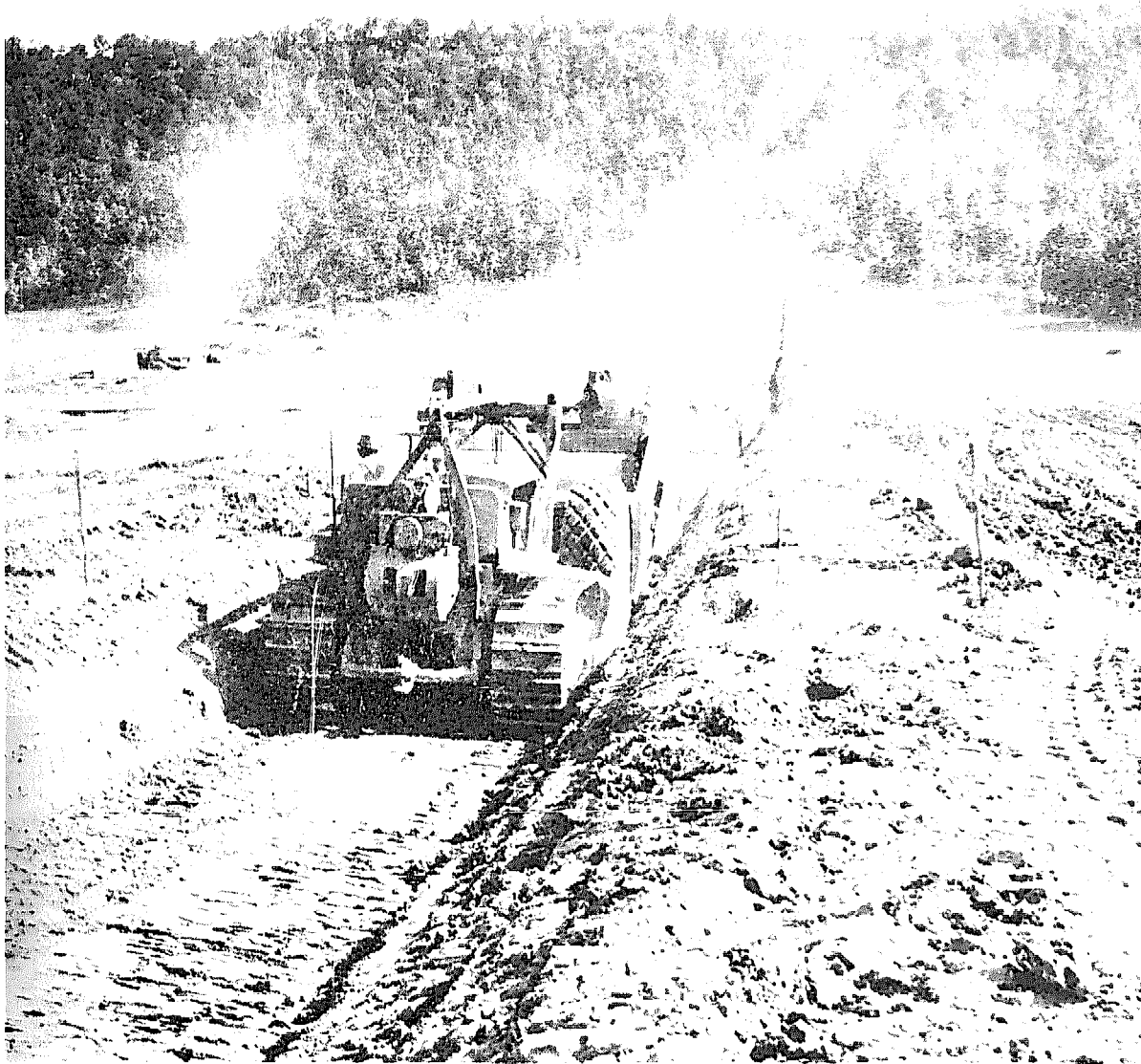

(Photo: U. S. Soil Conservation Service)

Fig. 11-13. Scraper and pusher excavating core trench for pond dam.

dam and the auxiliary spillway in order to make good conditions for growing grass.

Finally, plow or disk the dam site lengthwise to obtain a better bond between the new and the old soils.

7. Building the Core Wall

The purpose of a core wall is to prevent seepage water from flowing under the base of the dam. It is constructed by digging a trench 2 or more feet deep

lengthwise along the centerline of the dam site (Fig. 11-13). This trench should be deep enough to reach a dense, impervious layer. Backfill it with the most impervious soil material available. An impervious clay or sandy clay soil, well compacted, is best for this purpose. Be sure the side walls of the core trench are cut to slope no steeper than 1:1 to insure adequate bond with foundation material (Fig. 11-14).

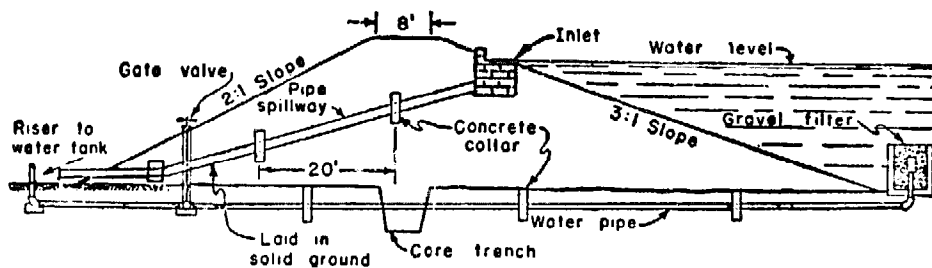

(From U.S.D.A. Leaflet 259)

Fig. 11-14. Cross section of fill showing core trench, pipe spillway, water pipe, side slopes, and top width.

8. Constructing the Fill

You are now ready to start construction of the fill. If you have made the proper survey, the base will be plenty wide. Without a wide base it is impossible to make the top wide enough. A good top width protects the dam against failure by wave action and from damage by rodents. You will also have allowed for gently sloping sides.

The fill material should not contain vegetation, large rocks, frozen soil, or other foreign substance. The material itself should be moist enough for good compaction. A good way to check for moisture is to knead a ball of the material in the hand. It is too dry if it cracks and separates; it is too wet if excess water can be squeezed out.

First fill around the spillway structure making sure

that the material is carefully placed and tamped by hand.

Then start moving the fill material into the dam itself. Filling should be distributed in layers 6 to 8 inches deep. Each layer should extend the full length and breadth of the dam. Compact each layer by running over it with the equipment before starting another layer. If the moisture content of the material is low, it should be sprinkled after compaction and before placing the next layer.

Gradually pull in the sides of the fill according to the planned slope as the fill rises. A template should be used to obtain a uniform slope from toe to top to conform to the design.

Continue building up the fill in shallow layers, compacting each one, until the fill has been completed.

The weight of the fill material itself will cause the dam to settle in time. Compacting it as described above will reduce this some but allowance should be made for approximately 5 per cent settlement even when well compacted. This means that the fill should be

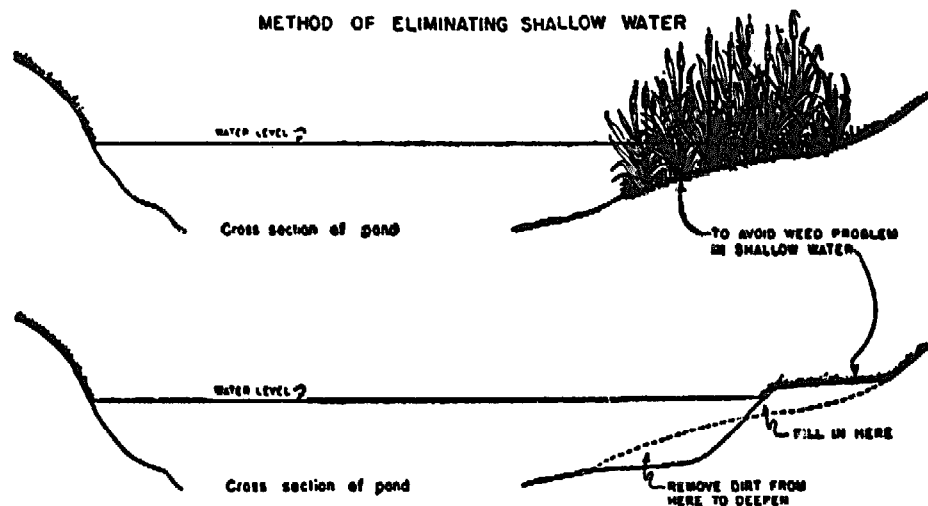

(Drawing: U.S.D.A. Farmers' Bulletin 1988)

Fig. 11-15. Pond edges should be deepened to control emergent water plants and improve fishing.

built approximately 5 per cent higher than the design calls for.

The pond fill can be improved greatly if the topsoil that was removed from the site is spread over the fill and the side spillway to provide a good seedbed for grass.

Water less than 2 feet deep has little or no value to fish. Shallow water is troublesome since it grows weeds. The edges can be made deep by taking soil for the fill from just below the water line. This line should be staked out in advance of the construction work anyway. This has advantages in that soil taken from above the water line leaves hard subsoil that is difficult to vegetate. Figure 11-15 shows the edges of the pond deepened by this method. It can be done after the pond is full of water if necessary. Almost every pond can be made better for fish production by deepening the edges.

Seed to Prevent Erosion

As soon as possible after the pond fill is finished, it should be seeded to prevent erosion. (Fig. 11-16.) A sod grass, or a standard pasture mixture, or other locally adapted vegetation will protect the fill from erosion. Plants with long tap roots should not be planted or allowed to grow on earth dams.

9. Building Excavated Ponds

Discussion so far has dealt with embankment ponds built by creating an embankment across a stream or watercourse. An excavated pond is built by digging a pit or dugout in a nearly level area. It is simple to build, but size is limited since all the capacity must come by excavation.

Some excavated ponds are fed by ground water



(From U.S.D.A. Agriculture Handbook 387)

Fig. 11-16. Pond fenced with banks planted to adapted grasses.

aquifers, and others are supplied only by surface runoff. Some ponds may be fed from both of these sources.

If the pond is to be fed by an aquifer, a thorough investigation of the site is essential. Test holes should be bored at intervals over the site to determine the amount and character of the flow. The water level in the test holes indicates the normal water level in the completed pond. The vertical distance between this level and the surrounding ground surface should ordinarily not exceed 6 feet; otherwise the cost of excavating may be too high.

The rate at which the water rises in the test holes indicates the yield of the aquifer and will determine how the water may be used, whether for irrigation or for stock water, and how much.

If surface runoff is to be the source of water, it is best to locate the pond on sloping terrain and use part

of the excavated material for a small low dam around the lower end to increase the capacity. An earth spillway will be needed to pass excess storm runoff around the dam.

In flat terrain excavated ponds usually require prepared spillways. If surface runoff enters an excavated pond through a channel or ditch rather than through a broad shallow drainageway, the overfall from the ditch bottom to the bottom of the pond can create a serious erosion problem unless the ditch is protected. Scouring can take place in the side slope of the pond and for a considerable distance upstream in the ditch. The resulting sediment reduces the depth and capacity of the pond.



(From U.S.D.A. Agriculture Handbook 387)

Fig. 11-17. Excavating a pond with a dragline.



(From U.S.D.A. Agriculture Handbook 387)

Fig. 11-18. A dugout constructed with waste material stacked along two sides.

The ditch can be protected by placing one or more lengths of rigid pipe in the ditch and extending them over the side slope of the excavation. The extended portion of the pipe may be supported by timbers or cantilevers.

Excavated ponds usually are built in a rectangular shape, because they are simple to build and can be adapted to all kinds of excavating equipment (Figs. 11-17 and 11-18).

10. Sealing Ponds

Excessive seepage in a pond is usually due to a poor site, one where the soils are too permeable to hold water. In some places, because of need for water, it is necessary to build a pond in a soil that is less than ideal. Sealing by whatever means is available then becomes necessary.

Compaction

Pond areas that contain a high percentage of coarse-grained material can be made relatively impervious by compaction alone if the material is well graded from small gravel or coarse sand to fine sand, clay, and silt. This method of sealing is the least expensive of all methods that may be tried.

Clay Blanket

Pond areas containing high percentages of coarse-grained soils but lacking sufficient amounts of clay to prevent high seepage losses can be sealed by blanketing with material containing a wide range of particle sizes varying from small gravel or coarse sand to fine sand and clay. The blanket should cover the entire area over which water is to be impounded. The blanket should be 12 inches thick for water 10 feet deep and should be increased by 2 inches in thickness for each foot of water over 10 feet.

Bentonite

Adding Bentonite is another way to reduce seepage in permeable soils. Bentonite is a fine-textured colloidal clay that will absorb several times its own weight in water, and it will swell to several times its original volume. When Bentonite is mixed in the correct proportions with the coarse-grained material, and the material is thoroughly compacted and saturated, the particles of Bentonite will fill the pores and make it nearly impervious. You will need a laboratory analysis of the fill materials in order to determine how much Bentonite to use. The rate of application ranges from 1 to 3 pounds per square foot. The Bentonite should be spread uniformly over the area to be treated at the rate determined by the laboratory analysis. It is then

overlap. Extreme care is needed to avoid punctures. The top of the lining is anchored by burying it in a trench dug completely around the pond at or above the normal water level.

It is strongly recommended that professional assistance or advice be requested in solving problems of pond seepage, since laboratory analysis of the soil is needed and no two sites are exactly alike.

Chapter

XII

PREVENTING AND HEALING GULLIES

Gullies that have developed over the ages through the process of geologic erosion are a part of the general configuration of the landscape. But many gullies are caused by accelerated erosion resulting from man's misuse of the land. These are the gullies that do most harm and are the kind that can be controlled.

Gullies cut up farm fields and cause difficulty in farming and in the use of machinery. Deep gullies cause water to drain from the soil, and in some areas lower the ground-water table. But damage from uncontrolled gullies is not limited to the land on which they occur. Sediment from eroding gullies deposited on bottomland may destroy its value. Sediment trapped in reservoirs and deposited in stream channels causes large economic losses. Sediment from gullies increases the cost of maintaining highways, railroads, pipelines, and other public utilities. Controlling gullies is an important phase of soil and water conservation.

The best way to control gullies is to prevent their formation. Gullies start when water is concentrated and flows over an area unprotected by vegetation. If natural drainageways, where runoff water collects

naturally, are kept well vegetated, the runoff from fields and within fields is carried to main-stream channels without causing damage. One of the first steps in planning a conservation program for a farm or ranch, or for a camp, school ground, park, or other area, is to plan for the safe removal of runoff so that gullies do not form.

In good conservation planning, natural waterways are used to carry runoff from the land. Channels are maintained in grass. During plowing and cultivating, equipment is raised when crossing waterways so as not to damage them. Forage and seed may be harvested from the waterway. With care, waterways can be grazed. And waterways are excellent habitat for certain forms of wildlife, especially ground-nesting birds. Local conservationists, extension agents, and vocational agriculture teachers can advise on the varieties of grass suitable for use in waterways.

A Suggested List of Activities Involving Approved Practices

1. Healing gullies
2. Diverting Runoff
3. Converting Gullies to Grass Waterways
4. Controlling Gullies with Structures
5. Using Temporary Structures
6. Using Permanent Structures

1. Healing Gullies

After gullies form they can be healed. Methods to use depend on the size of the gully, the size of the watershed that drains into it, the nature of the soil, and other factors, such as the use of the land surrounding the gully.

Nearly any gully will regain a cover of natural vegetation if it is in an area where vegetation will grow

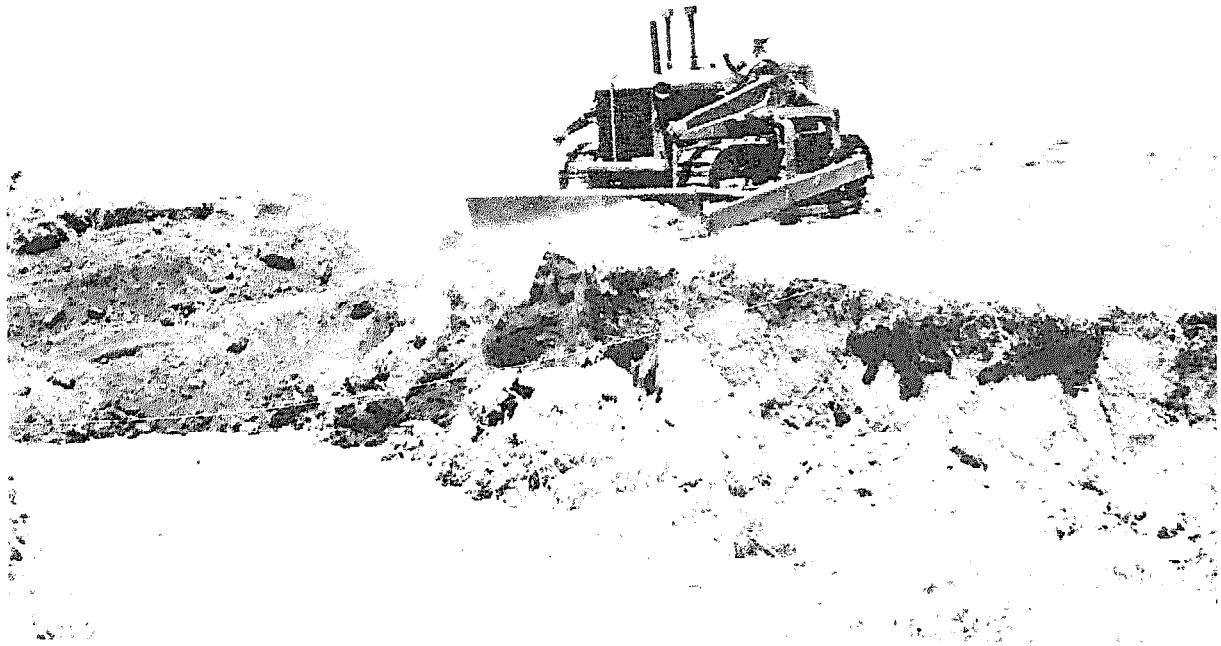

(Photo: U. S. Soil Conservation Service)

Fig. 12-1. The bulldozer is the best machine for pushing in the sides of gullies in preparation for shaping and seeding.

readily and if it is protected. If the flow of water that is causing the gully can be held back or diverted, vegetation alone may solve the problem. However, most gullied areas or banks are usually not in good condition for vegetative growth since the fertile topsoil has been washed away, slopes are steep, and the battering of raindrops on the unprotected soil makes a difficult site for vegetation to start. Once stabilized, the gully should not be cultivated, burned, or used in any way that will weaken or destroy the vegetation.

One of the simplest and cheapest ways to control small gullies (less than 6 to 8 feet deep) is to fence them and exclude livestock. In many situations this may be all that is needed. By protecting the area from trampling, grass, shrubs, or even trees will come in naturally and the gully will heal over. The fence should be placed far enough from the gully to allow a good growth of vegetation to form. A good rule is to set

the fence back from the edges of the gully bank a distance about equal to twice the gully depth.

If natural revegetation is too slow, grass, shrubs, or trees may be planted. Check with local conservationists for species to use that are adapted to the climate and to the soil at the site. Some bank sloping may be needed if the gully is to be planted, especially if the banks are vertical. However, when a gully is to be retired to woodlot or grass and stabilization is the only objective, only a little bank sloping should be done.

2. Diverting Runoff

It may also be necessary to divert water away from the gully by use of a diversion terrace. This would depend on the size of the drainage area and whether or not a suitable outlet is available. The use of diversions to control gullies is limited to small drainages, usually less than 50 acres because of the difficulty in handling large volumes of water. A diversion can be used only where there is a safe place to dispose of the water. If the outlet is subject to erosion, the water should not be diverted. This is one reason that diversions work well in pastures; usually there is plenty of space to provide a safe outlet. Diversions are discussed in detail in Chapter IX.

Where a small gully has started on an area of thin vegetation in pastureland, it is often possible to stop head cutting by building an eyebrow-shaped ridge above the gully head with the ends of the ridge leading slightly downslope onto good grass cover. This is a temporary measure and planting in the gully should be done promptly after the ridge is built.

3. Converting Gullies to Grass Waterways

Natural drainageways that have become gullied can



(Photos : U. S. Soil Conservation Service)

Fig. 12-2. These two pictures show how a gullied area is turned into a useful waterway.

be improved so that they will carry runoff safely. A practical way to transform a gully into a satisfactory waterway is to shape it and seed it to adapted species of grasses. This method is best adapted to small or medium gullies, up to 15 feet deep, that have small to medium drainage areas—that is, less than 150 acres. A properly shaped earth channel with good grass cover will carry runoff from the average farm or field without causing erosion.

Methods of shaping, seeding, and maintaining grass waterways are discussed in Chapter V.

Filling and Shaping

Some gullies or critically gullied areas are best treated by simply filling and shaping them. They should then be planted, the type of vegetation depending on the needs of the area and the use to be made of the land in and surrounding the treated area. When filling and shaping the gully or gullied area, the objective is to shape and smooth it so that the area can be established to vegetation and maintained with regular farm equipment.

During the filling process the soil is worked into the gully and compacted. This is an important step since uncompacted material offers little resistance to erosion. The bulldozer is an excellent machine for pushing in the sides of gullies and compacting the fill material. It is best to fill the gullies during the time of year that a close-growing crop may be seeded immediately on the disturbed area to protect it from washing. Do not attempt to block the gully by partially filling spots along the waterway channel. This merely creates waterfalls which wash out quickly, causing more soil to be lost than if the gully were left untreated. The gully should be completely filled and shaped in one operation. Short-term protection should be provided by planting a tem-



(Photos : U. S. Soil Conservation Service)

Fig. 12-3. A pasture gully shaped and seeded to grass makes a useful waterway.

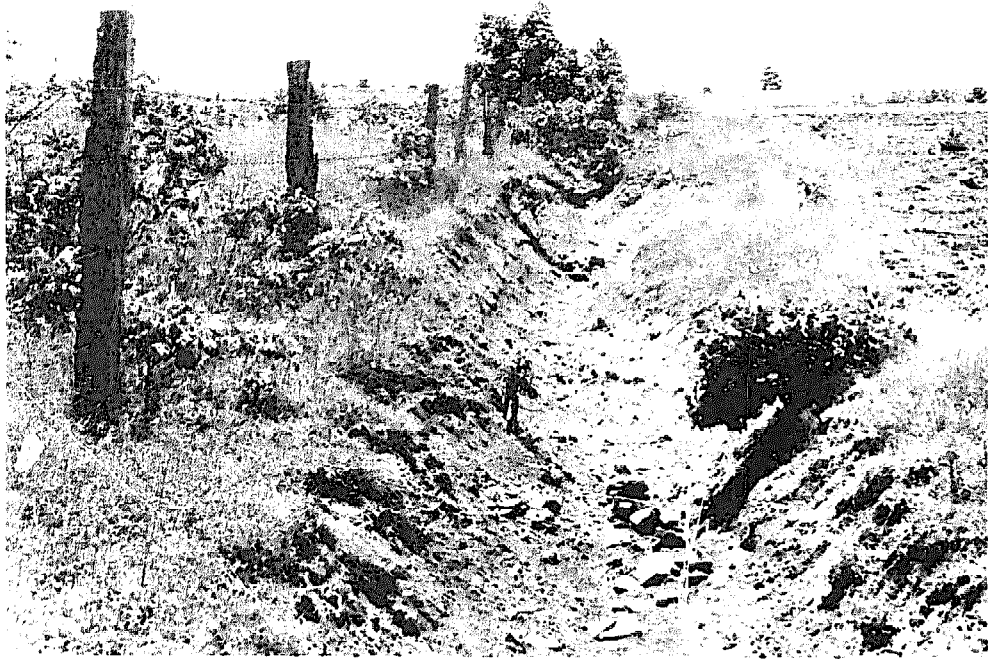

(Photos : U. S. Soil Conservation Service)

Fig. 12-1. This gully was started when terraces emptied on an unprotected fencerow. Shaping and seeding solved the problem.

porary stabilizing crop of some kind. Corn, planted thickly, does an excellent job of holding the soil until a more permanent type of vegetation can be planted.

4. Controlling Gullies with Structures

There are places where vegetation cannot be used to stabilize gullies. Some gullies are too deep, they drain too large a watershed, the soil is too unstable, or for other reasons vegetation will not, by itself, prevent the detachment and loss of soil along the gully. In such situations it is necessary to use more substantial methods that will keep the gully stable even though vegetation dies out. You may need the advice of a professional conservationist to determine where vegetation alone will not suffice and where structures are needed.

Structural measures consist of varying designs built for the purpose of stabilizing the grade and halting further erosion. Without vegetation, any grade steeper than about 1 per cent will scour; and to be safe, a grade of 0.5 per cent or 6 inches fall in a hundred feet should be the objective. Of course vegetation makes it possible to have a stable grade considerably steeper than this.

In a grade that is stable without vegetaion, silt will settle out of the water and accumulate in the bottom of the gully. Thus, under bare ground conditions, a stable grade may also be called a silting grade. Due to the difference in soils, there is no exact grade that is stable under all conditions. Probably the best and easiest way to determine a silting grade is to investigate the grade of gullies in the area that appear to be stable—that is, that are not actively eroding in the bottom of the channel. As a general rule, without vegetation, the silting grade should be kept within the limits of 6 inches fall per hundred feet of gully. Proper design and spacing of structures makes this possible;

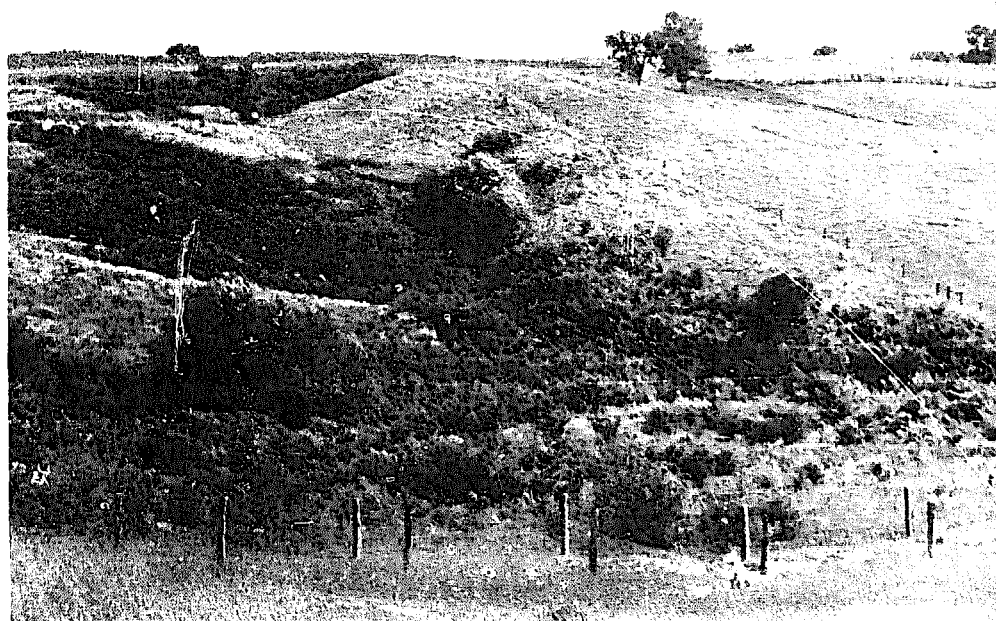

(Photos: U. S. Soil Conservation Service)

Fig. 12-5. Some gullies can be healed by planting, and by fencing to protect the new growth from farm animals.

with structures you can determine the exact amount of fall above a structure or between structures.

5. Using Temporary Structures

Many kinds of temporary structures—brush dams, log dams, wire dams, rock dams—have been used to stabilize gullies while vegetation is being established. These temporary structures are not generally recommended because they eventually fail, leaving the problem unsolved. They have to be replaced and involve cost and labor that could better be used elsewhere.

6. Using Permanent Structures

Permanent structures usually are built of reinforced concrete or masonry or of earth with concrete or steel pipe spillways. They are used in medium to large gullies—usually more than 8 feet deep and draining more than 50 acres—where vegetation alone cannot successfully control them. Permanent structures are expensive and require special equipment, skilled labor, and special materials. They should be built only after engineering studies and adequate plans have been made.

Three basic structures are used in stabilizing gullies: drop inlet, drop spillway, and chute. Each is adapted to specific conditions, and the selection of one or another can be determined only by an engineer after examining the site.

Drop Inlets

The drop-inlet dam is ideally adapted for grade stabilization or control of advancing gully heads when the gully is more than 10 feet deep. It consists of an earth dam with a drop-inlet spillway of concrete or metal pipe. The spillway has a vertical section on the

upstream side of the dam, called the riser, which is connected to a culvert or barrel passing through the earth dam. The crest of the riser is set at the elevation required to stabilize the grade upstream or to protect the gully head. Water must rise to the top of the riser before it can be discharged downstream

Usually an earth emergency spillway is built around one end of the dam to take the infrequent high flood flows. The spillway should be cut into undisturbed earth far enough away from the earthfill so that there is no danger of the floodflow coming in contact with the downstream slope of the fill. The grade in the spillway should be gently sloping so that vegetation may be established to protect it against erosion. The emergency spillway is higher than the crest of the riser and lower than the top of the earth dam. The emergency spillway should have a good cover of vegetation, a uniform width, a gradual slope to the channel downstream, and no abrupt turns. It should be wide enough and have enough capacity to handle any flood that may be expected, since its purpose is to safeguard the structure by avoiding any possibility of floodwaters' going over the dam.

The emergency spillway should be enough higher than the crest of the drop inlet to permit the drop inlet to run full and thus to discharge at its full capacity before the emergency spillway functions. By using an emergency spillway and by building the dam high enough to temporarily store some floodwater, the size and cost of the drop-inlet structure can be reduced. It is, therefore, not necessary to design the structure large enough to handle all of the floodflow. This might not be economical. Properly designed, a combination of earth dam, drop inlet, and emergency spillway can store water during severe flooding and allow it to be discharged over a longer period of time. Thus a com-

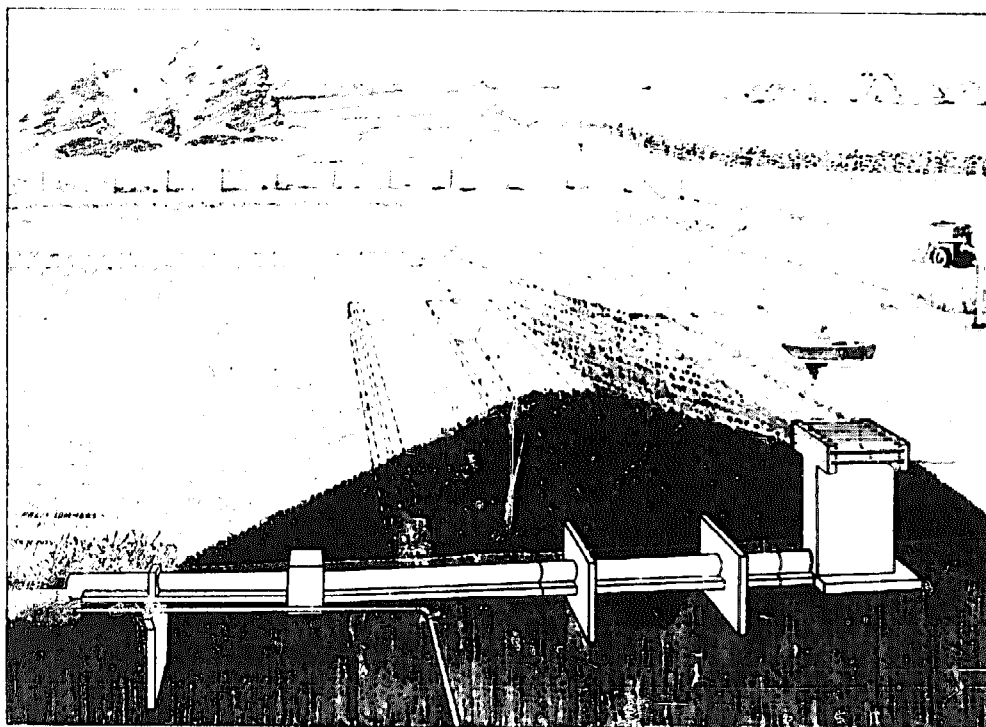

(Drawing : U. S. Soil Conservation Service)

Fig. 12-6. This drop inlet is made of concrete.

bination of gully control and flood retardation is accomplished.

Eventually the gully will silt up to the top of the riser and will be stabilized at that point.

The outlet end of the drop inlet is placed at or slightly above the elevation of the grade below the dam. Ordinarily the grade below a permanent structure should be completely stable, otherwise the gully will undercut the structure and it will fail. By using a propped outlet it is possible to install structures at locations where the grade downstream is not considered completely stable. A propped outlet consists of a pipe extended about 8 feet below the toe of the dam supported by piling or a concrete pier. The support is placed 6 to 8 feet from the end of the pipe to protect it from the scour hole that will form. The advantage of the propped outlet is its low cost and its ability to

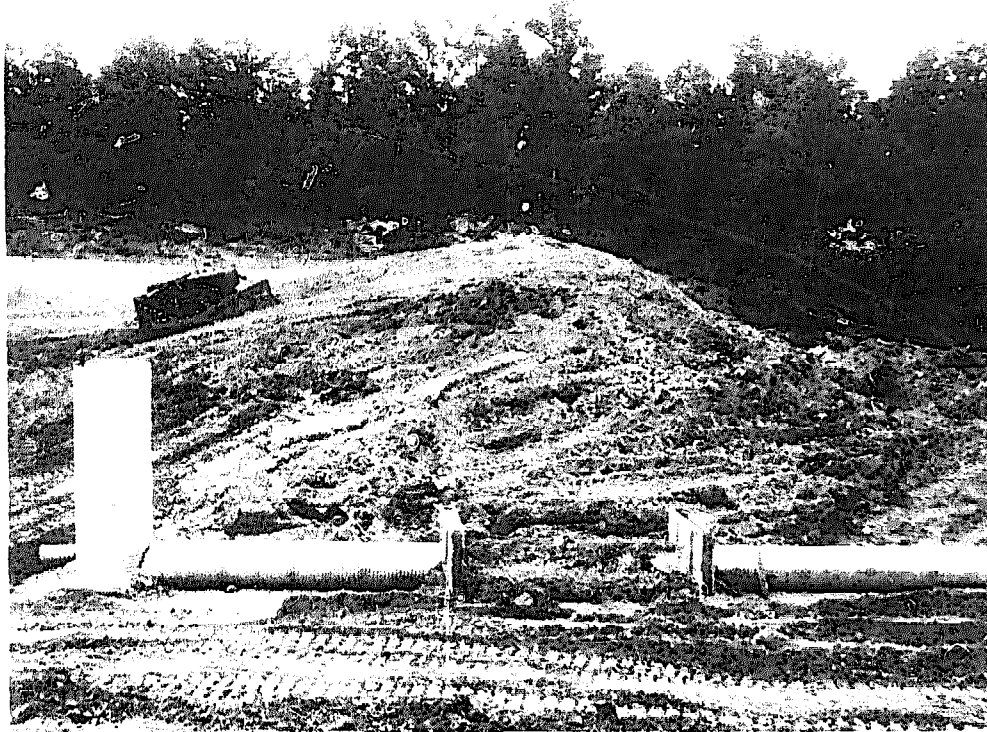

(Photo: U. S. Soil Conservation Service)

Fig. 12-7. A drop inlet made of corrugated pipe placed in a large gully. It will be covered with earth to form a dam.

discharge water far enough downstream so as not to endanger the structure. If the grade lowers excessively downstream from the outlet, the outlet can be extended and lowered at a reasonable cost.

As a general rule, a drop inlet with a propped outlet should not be built where the grade downstream averages more than 1 per cent. In places where grades are steeper than 1 per cent, another structure should be built downstream at a point where the resultant grade is less than 1 per cent.

Drop Spillways

Drop spillways are built of reinforced concrete, masonry, or sheet piling. They are somewhat like the

old mill dams built in small streams to serve as a source of power. Because dams in dry draws are not subject to continuous flows, the drop spillway is simpler to design and of lighter construction. It can be designed for almost any height, but it is best adapted to drops of 10 feet or less. The total storm runoff usually passes over the crest of the drop spillway. Emergency earth spillways are seldom used in connection with drop spillways.

Drop spillways require careful design of the apron or floor, on which the water falls, to dissipate the energy before passing to the channel below. Unless the energy of the falling water is dissipated at the base of the spillway, the channel will scour immediately below the structure. Excessive scouring immediately downstream may result in undercutting the structure. Drop spillways, therefore, are used only at places where

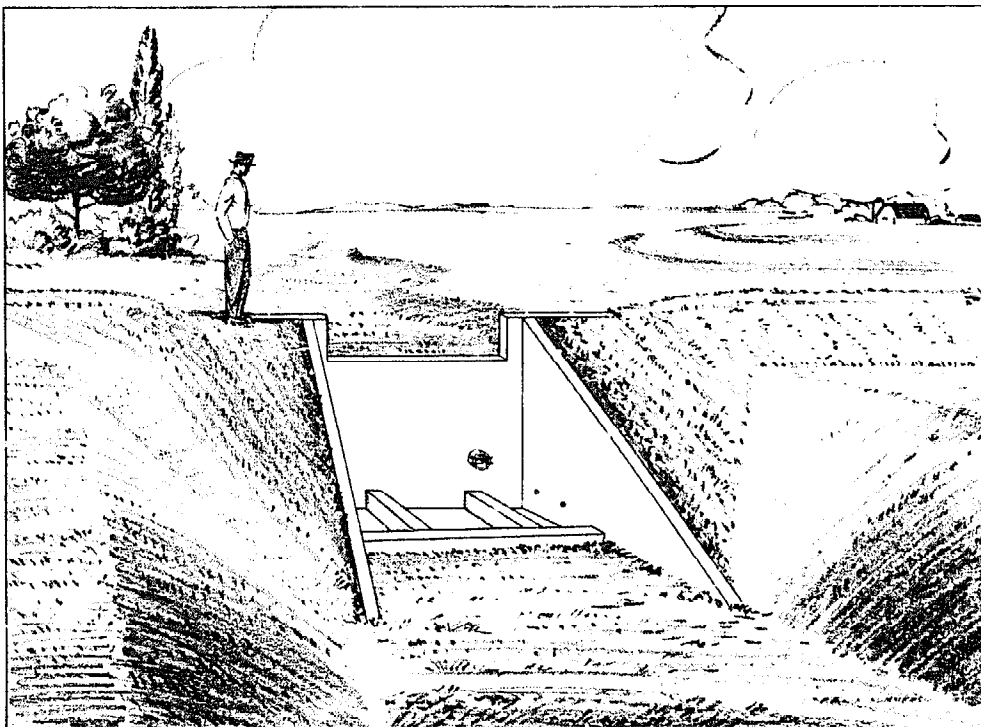

(Drawing : U. S. Soil Conservation Service)

Fig. 12-8. This is a straight drop spillway.

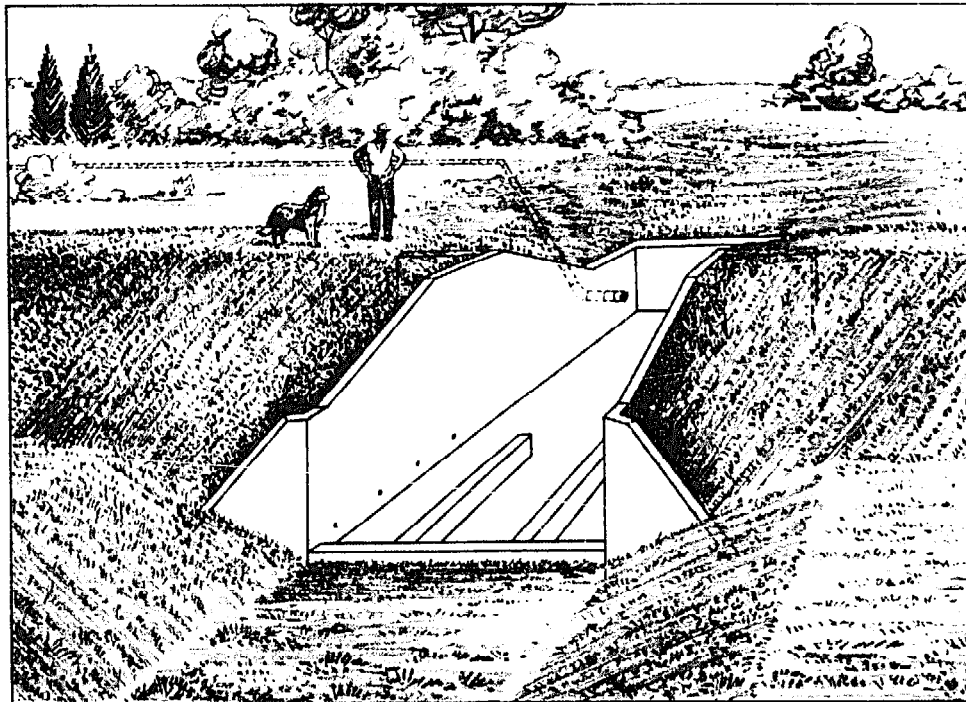

(Drawing : U. S. Soil Conservation Service)

Fig. 12-9. The box-inlet drop spillway is used where the channel is narrow. Water drops into the spillway from three sides.

the grade downstream from the structure has been carefully studied and determined stable. Earthfills are used to connect the structure with the earth abutments.

Box inlet drop spillways are variations of the drop spillway.

Chutes

Chutes are used in combination with earth dams where it is necessary to drop water farther than is ordinarily feasible with drop structures. They are built of reinforced concrete.

Chutes should be constructed on foundations on original ground or on fill that has been carefully compacted under controlled conditions. The chute is susceptible to movement because of frost action or other causes. Closely spaced expansion joints are required to

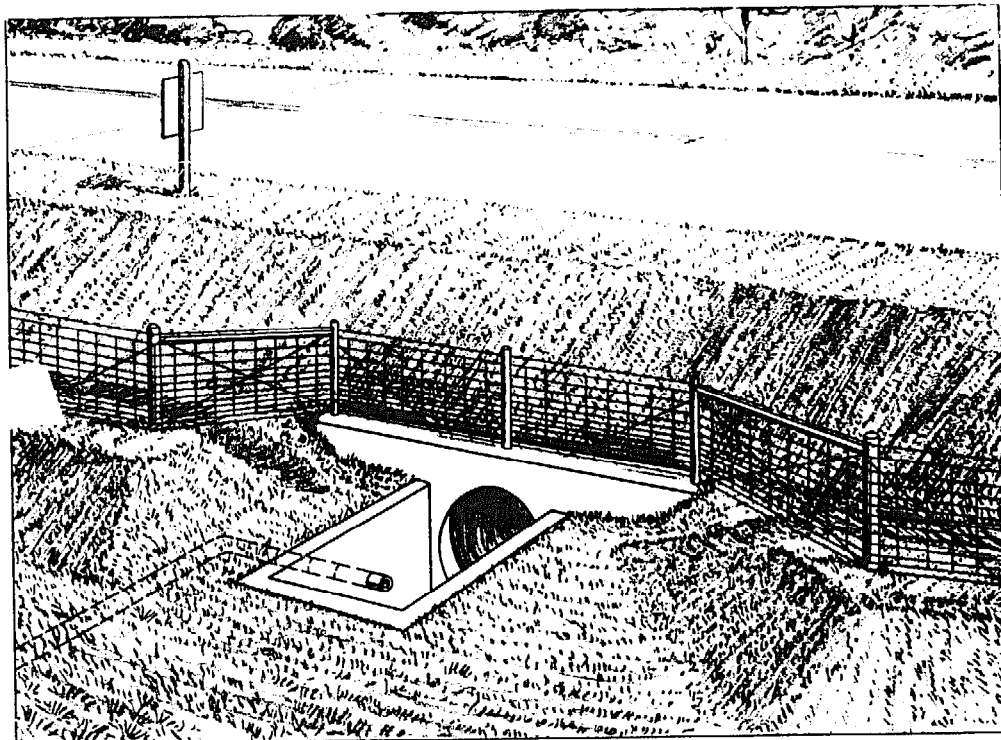
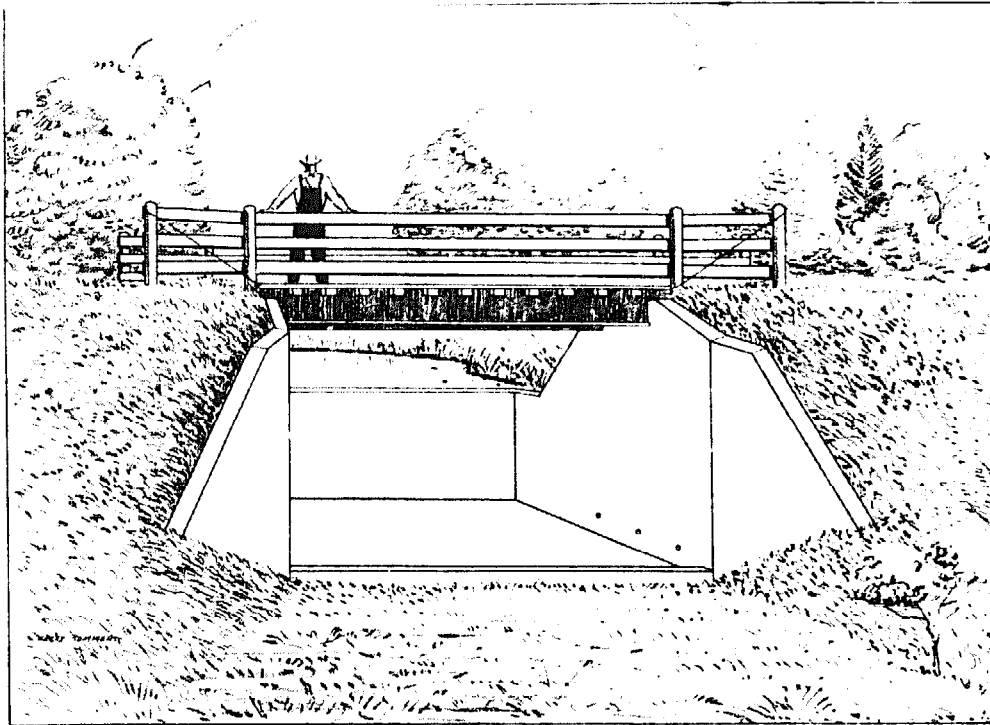

(Drawings: U. S. Soil Conservation Service)

Fig. 12-10. Two types of box-inlet spillways useful for stabilizing gullies at road crossings.

relieve the structure of stress that would cause cracking. Chutes are individually designed to fit specific site conditions. Engineering services are needed.

Permanent structures are discussed here in order that students, land owners, and other readers may become familiar with the various types and may come to understand where they may be used to support a conservation plan on a given farm, ranch, camp, school ground, or other property. Permanent structures are expensive to install. Good materials and safe designs are essential for satisfactory results. The sizes and costs of the structures needed to control a gully or system of gullies vary widely. Engineering assistance is needed in making a study of the site and in designing a structure to fit the situation.

Standard plans have been developed for some types of permanent structures that can be used successfully

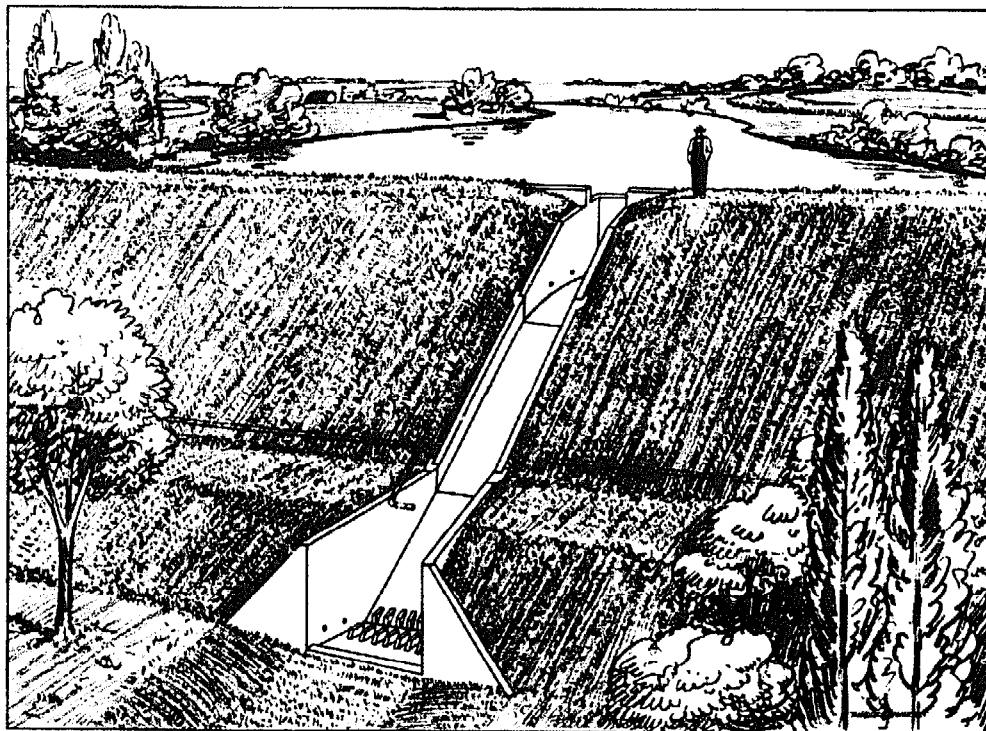

(Drawing : U. S. Soil Conservation Service)

Fig. 12-11. A chute spillway is used for dropping water farther than is feasible with drop spillways.

when they are used in the right places. These standard plans are usually limited to drop spillways that have a height of 5 feet or less and to small drop inlets that have a total height of fill less than 15 feet. These small structures can usually be built by a farmer, or by a high school shop class under the guidance of the instructor, with technical assistance from conservation engineers. The local office of the Soil Conservation Service or the Extension Service can advise as to what technical assistance is available to assist with the survey, design, and installation for a gully-control structure. The Soil Conservation Service can furnish information on the standard plans for the smaller permanent-type structures.

Chapter

XIII

CONTROLLING EROSION ON CONSTRUCTION SITES

Damage from soil erosion is not limited to farms and ranches. Land under development for nonfarm uses erodes during construction and causes widespread damage to the site and to other areas. Studies show that erosion per acre on land going into use for highways, houses, or shopping centers is about 10 times greater than on land in cultivated row crops, 200 times greater than on land in pasture, and 2,000 times greater than on land in timber.

Damage to the land does not come from erosion alone. The increased runoff erodes stream banks and channels and causes flooding below the construction site. Sediment pollutes streams, lakes, and reservoirs and damages the area where it comes to rest.

Erosion-control methods used successfully on farms and ranches can be adapted to the urban problem. In many situations the urban problem is more severe, and the methods used must be applied more intensively than on farmland.

By following some basic principles on the use and treatment of land, erosion on the site can be controlled and the cost can be kept reasonable. Carefully



(Photo: U. S. Soil Conservation Service)

Fig. 13-1. Uncontrolled runoff damages the construction site and carries the sediment that damages areas downstream.

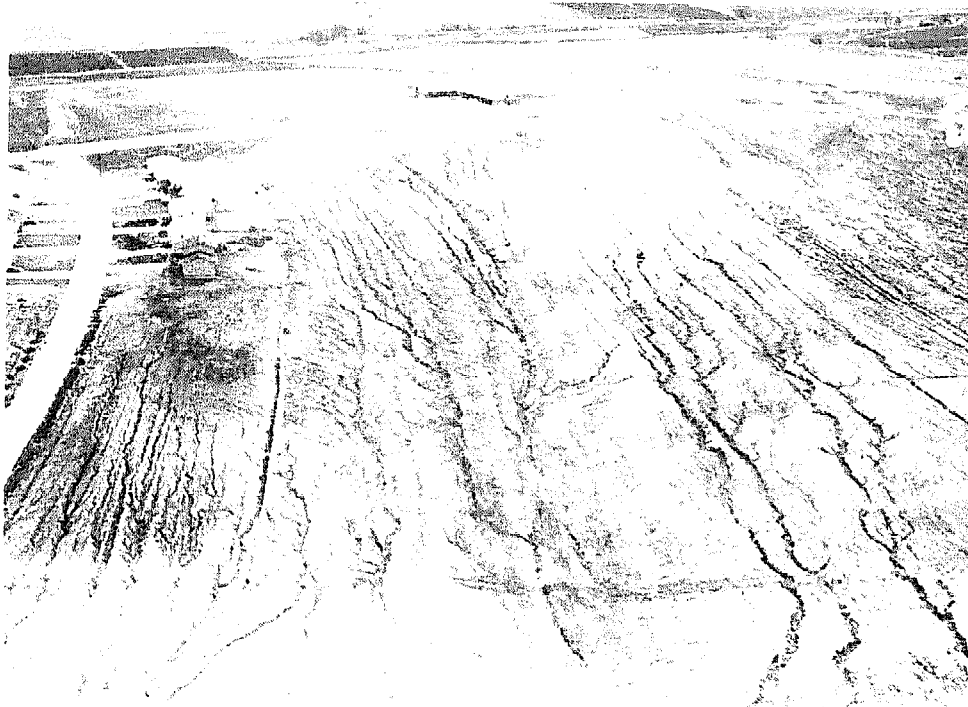

(Photo: U. S. Soil Conservation Service)

Fig. 13-2. Grading more land than is needed for immediate construction can result in severe erosion and sedimentation.



(Photo: U. S. Soil Conservation Service)

Fig. 13-3. Serious gully erosion and tons of sediment from this unprotected construction site.



(Photo: U. S. Soil Conservation Service)

Fig. 13-4. Clearing before construction—a common practice that leads to serious erosion.

selecting the building site, and using soils that are suitable for the development will avoid many problems. Other suggestions are: leaving the soil bare for the shortest time possible, grading at a minimum and removing only undesirable trees wherever possible; using mechanical methods to control runoff water and conveying it to storm sewers or other outlets so it will not erode the land; protecting critical areas during construction with mulch or temporary cover crops; constructing sediment basins to detain runoff and trap sediment during construction; and establishing permanent vegetation and installing erosion-control structures as soon as possible.



(Photo: U. S. Soil Conservation Service)

Fig. 13-5. Sediment in this storm drain came from a nearby construction site.

Soil Information

In selecting the building site and in adapting the building project to the site, information about the soil is necessary. Soil surveys have been made or are being made in virtually every county in the nation. Information available from these surveys can be obtained from the local soil conservation district or the Agricultural Extension Service. Soil surveys describe the characteristics and give the limitations of the soils for various uses. No construction should be planned without first studying the soil survey information at the site under consideration.

Erosion and Sediment Control Measures

There are two kinds of erosion and sediment control measures—mechanical and vegetative. Both will be needed on most sites.

Mechanical Measures

Mechanical measures are used to reshape the land to intercept, divert, convey, retard, or otherwise control runoff.

Land Grading

Grade only those areas going into immediate construction rather than grade the entire site. On large tracts, grade units of workable size at one time. As construction proceeds, grade another unit. Both these suggestions will help immensely in controlling erosion. As a general rule, do no more grading than is absolutely necessary to make the site suitable for the intended purpose. Remove only undesirable trees wherever possible. Heavy grading almost always increases erosion hazards and should be accompanied by the maximum

use of appropriate erosion-control measures. If heavy cutting and filling are necessary to increase the percentage of usable land, the new slope should be gentle enough to allow easy stabilizing and maintenance.

Stumps and other decayable materials should not be used in fills.

Diversions

Diversions intercept and divert runoff so that it will not cause damage; they consist of a channel and a ridge constructed across the slope. Diversions need a stable outlet to dispose of water safely.

In many places diversions are placed above critical slopes to divert runoff where runoff over such slopes



(Photo: U. S. Soil Conservation Service)

Fig. 13-6. This diversion protects a steep cut slope by diverting runoff water to a safe outlet.

would cause serious erosion. Diversions can be used in this way to protect the site while the building is going up. Diversions can be used in a series on long slopes if needed.

If the diversions are to be permanent they should be seeded to the same grasses that cover the surrounding area. If built to protect open spaces, they should blend into the landscape for both better appearance and ease of maintenance.

Berms

Berms are a type of diversion. They are compacted earth ridges on a slight grade and have no channels. They may be permanent or temporary.

Berms can be used to protect newly constructed slopes until the slopes are stabilized with permanent vegetation. They can be constructed across graded rights-of-way in a series and at intervals needed to intercept runoff. The side slopes of berms are made flat enough to allow work vehicles to cross over them. Berms must have stable outlets.

Outlets

Most outlets are grassed waterways, either natural or manmade, and serve to dispose safely of water from diversions and berms, and from parking lots, highways, and other areas.

Outlets should have gently sloping sides and wide bottoms so that they can be easily maintained. They should be large enough to handle the water from the area drained.

A variety of grass should be selected that grows well locally and that produces a dense uniform cover. It should be able to withstand small amounts of sedimentation and provide protection during all seasons of

the year. It may be necessary to protect the seeding while the vegetation is being established by using some artificial covering such as jute matting or fiber glass.

Waterway Stabilization Structures

A waterway needs a stabilizing structure if its slope is so steep that the velocity of runoff will cut the vegetative planting that has been established. Grade stabilization structures consist of drop spillways, special culverts, and various kinds of pipe used in combination with vegetation. Engineering help will probably be needed in designing the structure to fit the needs of the site.

Lined Channels

Where vegetation alone will not handle the runoff it may be necessary to line the channel with concrete. Such channels, paved ditches, and valley gutters have many uses in urban areas where slopes are too steep or soils too unstable for control by vegetation alone. Fiber-glas mats can be used as temporary lining for ditches and channels.

Sediment Basins

A sediment basin can be excavated or formed by a combination of dam and excavation. Earth dams can be constructed across waterways to form basins. Usually a pipe under the embankment or some other form of outlet is needed to discharge water.

The purpose of a sediment basin is to hold runoff water and allow sediment to settle out, thus trapping the sediment and preventing damage to areas downstream. By holding the runoff, sediment basins also reduce the peak of water flow downstream.



(Photo: U. S. Soil Conservation Service)

Fig. 13-7. In some places it is necessary to pave ditches, as was done here. The sides have been seeded and mulched.

Sediment basins are almost always temporary structures. During construction they trap sediment and the sediment may be dredged out and used for fill or for other purposes. The basin can continue to function. After the construction is completed and the area has been stabilized, the sediment basin can be graded into the surrounding landscape. Sediment basins can be designed as permanent structures if there is a permanent need for them.

The sediment basin should be located, designed, and constructed in such a way that serious damage to areas downstream would be avoided should the basin fail.

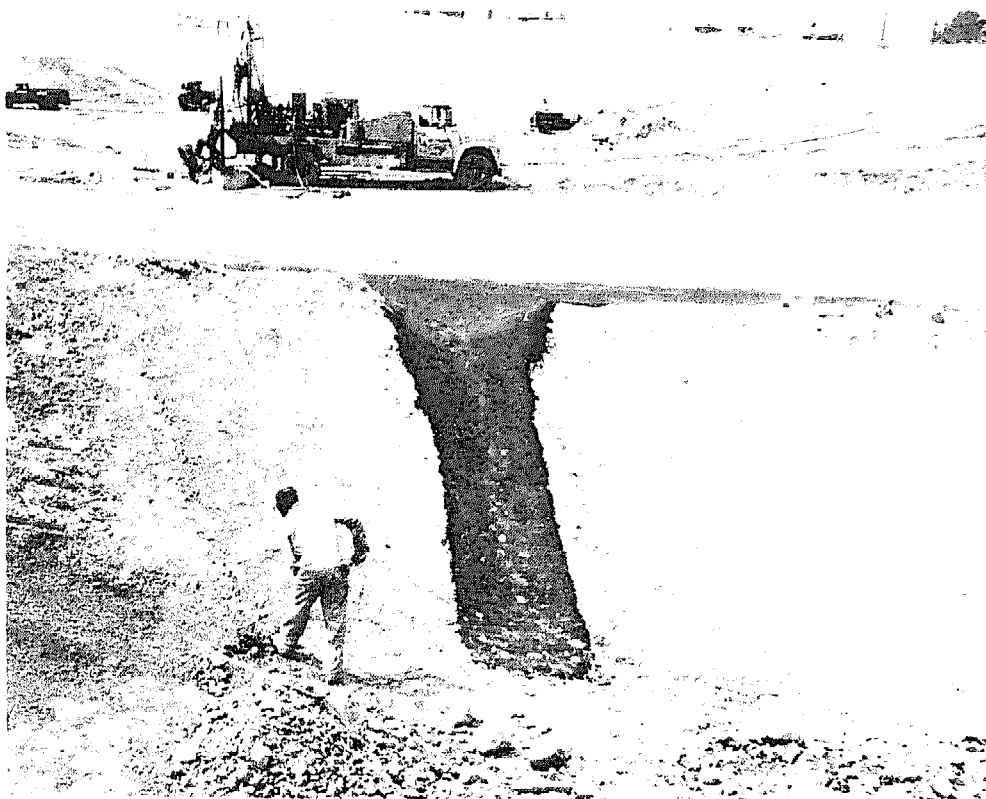

(Photo: U. S. Soil Conservation Service)

Fig. 13-8. This asphalt-paved apron and drop chute will carry runoff into the sediment basin.

Stream Channel and Bank Stabilization

Increased runoff from construction sites may make it necessary to stabilize the stream channel below. Stream channels can be stabilized by installing grade control structures or by paving. Undercutting of banks can be controlled by measures that withstand the flow, such as concrete structures or rock riprap built along the toe and lower facing of the bank. Jetties, pilings, and fencing can be built into or along the channel.

Stabilizing stream channels and streambanks is usually complex and costly. Control measures should be undertaken only on the basis of thorough engineering studies and plans.

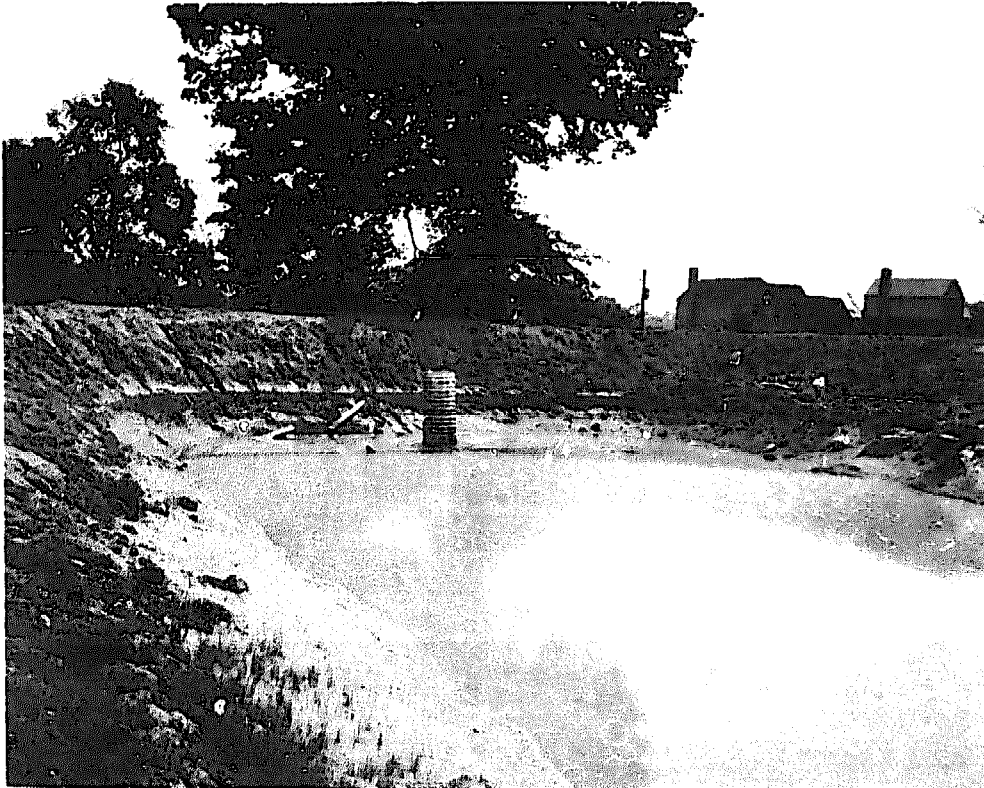

(Photo: U. S. Soil Conservation Service)

Fig. 13-9. This temporary sediment basin has a perforated riser to make easier the gradual drawdown of impounded runoff.

Vegetative Measures

Vegetative measures provide temporary cover to help control erosion during construction. Vegetation can provide permanent cover to stabilize the site after construction is complete. Vegetative measures include the use of mulches and temporary and permanent cover crops.

Erosion can be controlled with less difficulty on some sites than on others during construction, and permanent cover is easy to establish on some sites and difficult on others. Establishing and maintaining good plant cover is easy in areas of fertile soil and moderate slopes. Usually such areas can be stabilized by using

the plants and cultural methods that are common in the community.

Sites that are difficult to stabilize, because of exposed subsoil, steep slopes, a droughty exposure, and other unfavorable conditions, require special treatment. Such sites are called critical areas because they erode severely and are the source of much sediment if they are not well stabilized.

Mulch

Mulch can be used to protect constructed slopes and other areas that have been brought to final grade during a time that is unfavorable for seeding. When favorable seeding time does occur, seeding can be accomplished without removing the mulch. In fact, the mulch



(Photo: U. S. Soil Conservation Service)

Fig. 13-10. Paper netting helps secure straw mulch on a newly seeded waterway.



(Photo: U. S. Soil Conservation Service)

Fig. 13-11. Hydroseeder spraying a water solution containing seed and fertilizer on newly graded slope.

will make it easier to get a seeding established because the mulch holds moisture and protects the tiny seedlings from weeds, sun, and wind.

Mulch is essential in establishing good stands of grasses and legumes on steep cut-and-fill slopes and other areas where it is difficult to establish plants. Mulch allows more water to infiltrate the soil. It also reduces the loss of soil moisture by evaporation; it holds seed, lime, and fertilizer in place; and it reduces seedling damage from heaving of the soil caused by freezing and thawing.

The materials most widely used in mulching are small-grain straw, hay, and certain processed materials. Grain straw is easily applied and is usually less expensive and more readily available than hay. Straw and hay mulches are usually applied at the rate of $1\frac{1}{2}$ tons per acre.



(Photo: U. S. Soil Conservation Service)

Fig. 13-12. Mulching machine operating on new fill.



(Photo: U. S. Soil Conservation Service)

Fig. 13-13. Notched disk cutting notches into which mulch is anchored.

A number of processed mulches are available, and some show promise of greater use under specific conditions. Hydromulching, in which seed, fertilizer, and mulch are applied as a slurry, is a fast, all-in-one operation that requires little labor. Hydromulching may not be successful if done during a period of high-intensity storms.

Straw and hay mulches can be anchored to keep them from blowing or washing away. Anchoring methods include spraying the mulch with asphalt, tucking the mulch into the soil with a straight-blade disk, stapling netting over the mulch, and driving pegs into the mulched area at intervals of about 4 feet and interlacing them with twine.

Temporary Cover Crops

Temporary cover crops can be used where cover is needed for a few months or a year or two. If construction is delayed on a site that has been cleared and graded, temporary cover crops can be used to protect the site against erosion. And they can be planted at a time of year that is unfavorable for seeding and establishing permanent cover.

Rapidly growing plants, such as annual ryegrass, small grain, Sudan grass, and millet, are most often used for temporary cover.

Fibrous Materials

A number of fibrous materials have special uses in erosion control. Jute netting—a coarse, open-mesh, weblike material—can be applied directly on the soil to protect newly seeded channels until vegetation becomes established. It can also be used in repairing outlets and diversions where gullies have cut the channel. In some places it can be used to hold down straw mulch.

Cotton netting and paper netting are both light-



(Photo: U. S. Soil Conservation Service)

Fig. 13-14. Fibrous protective materials over a variety of plantings.

weight; they can hold straw mulch in place and prevent it from blowing or washing away.

Solid heavy-duty fiberglass matting can be used as a temporary channel liner where water velocity is too high for the use of vegetation or where vegetation is not wanted. Impregnating the mat with asphalt prolongs its life. Perforated fiberglass matting can be used in the same way as jute netting to protect newly seeded channels.

Stabilizing Critical Areas

Graded or cleared areas, such as cut-and-fill slopes, may be subjected to erosion for up to 12 months and need immediate treatment. The first requirement is to



(Photo: U. S. Soil Conservation Service)

Fig. 13-14. Fibrous protective materials over a variety of plantings.

weight; they can hold straw mulch in place and prevent it from blowing or washing away.

Solid heavy-duty fiberglas matting can be used as a temporary channel liner where water velocity is too high for the use of vegetation or where vegetation is not wanted. Impregnating the mat with asphalt prolongs its life. Perforated fiberglas matting can be used in the same way as jute netting to protect newly seeded channels.

Stabilizing Critical Areas

Graded or cleared areas, such as cut-and-fill slopes, may be subjected to erosion for up to 12 months and need immediate treatment. The first requirement is to

prevent runoff from flowing over the face of the slopes. Temporary diversions, berms, or shoulder dikes should be used to intercept and divert the runoff. Permanent structures such as brow ditches and valley gutters are needed where the areas contributing runoff are large—for example, in areas of highway construction.

Small benches or interceptor ditches can be used to protect long slopes from runoff originating on the slope itself.

Methods of establishing vegetation vary for different parts of the country, depending on the plants used and on soil and climate. In selecting plants and in get-

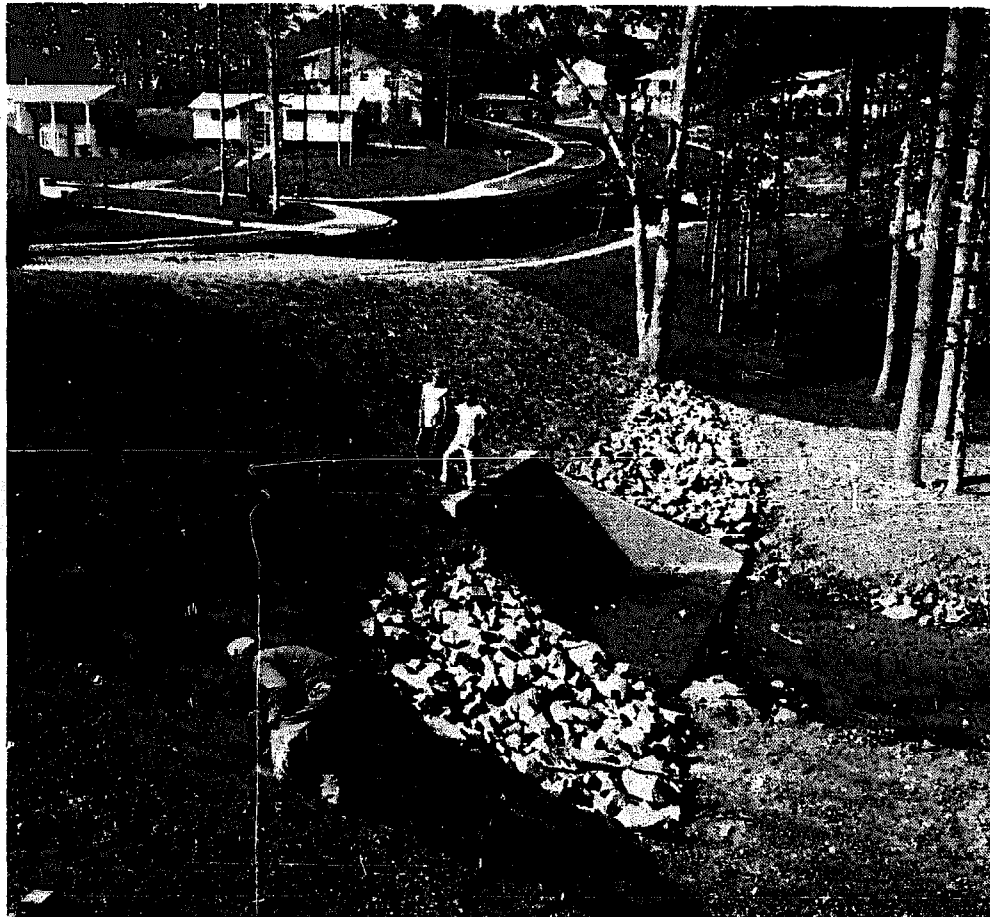

(Photo: U. S. Soil Conservation Service)

Fig. 13-15. Conservation measures have stabilized this critical area.

ting them established, it is best to be guided by the methods commonly used and recommended in the area.

After the grading is completed and the ditches, diversions, and other needed measures are installed, a seedbed should be prepared as thoroughly as the site conditions will permit. Lime and fertilizer should be applied, based on local standards or on soil tests. Generally from 500 to 800 pounds per acre or 11 to 18 pounds per 1,000 square feet of 10-10-10 or equivalent fertilizer should be used in addition to lime as needed according to test. The lime and fertilizer should be worked into the soil to a depth of 4 inches with a disk, springtooth harrow, or other suitable equipment. On sloping land the final harrowing or disking operation should be across the slope.

Usually a good stand of grass can be obtained by broadcasting, drilling, or hydroseeding. After seeding, apply the mulch materials. Apply the mulch evenly (if straw, 1½ tons per acre or 70 to 90 pounds per 1,000 square feet) so that approximately 75 per cent of the soil surface will be covered. The mulch should then be anchored.

There are several methods of anchoring mulch. The peg and twine method consists of driving 8- to 10-inch wooden pegs into the soil, leaving 2 or 3 inches exposed, every 4 feet in all directions. Stretch twine between pegs in a criss-cross within a square pattern. Mulch netting of lightweight paper, jute, cotton or plastic is available usually in rolls 4 feet wide and up to 300 feet long. Nettings are stapled down.

Another method, suitable for small areas, is to use a square pointed spade and cut the mulch into the soil in rows 18 inches apart. A tractor-drawn implement especially designed to punch and anchor mulch into the soil is available in some places. Its use is limited to slopes upon which a tractor can operate safely.

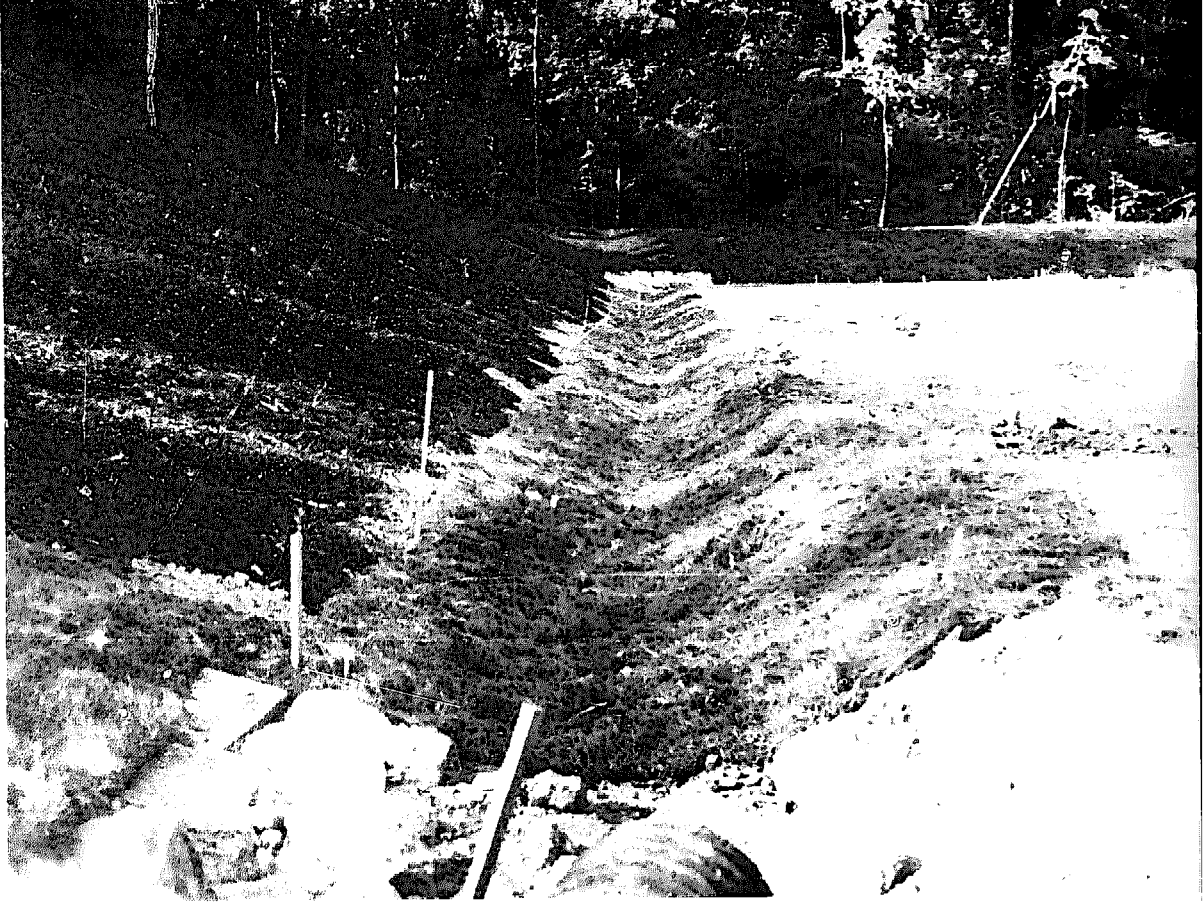

(Photo: U. S. Soil Conservation Service)

Fig. 13-16. This channel was sodded to give immediate protection. The slope has been planted to honeysuckle and mulched with tanbark.

Emulsified asphalt applied as mulch material is blown from the applicator and provides excellent mulch anchorage.

Sodding

Sodding is more costly than seeding, but it provides immediate protection. Sodding may be necessary in small, critical spots, and should be used where the runoff is concentrated and other methods will not be effective. Sod strips should be laid across the slope, anchored to the soil, and watered. Sod responds to a good seedbed and to lime and fertilizer.

Chapter

XIV

CONTROLLING SANDBLOWS

Sandy areas are a danger zone on many farms. Approved practices, correctly applied, will prevent much damage to such soil areas.

A Suggested List of Activities Involving Approved Practices

1. Stabilizing Sandblows
2. Planting Trees

1. Stabilizing Sandblows

Bare sand is not only unproductive—it may do great damage by covering cropland, pasture and forest or by filling drainage ditches and blocking roads. Sandblows can be stabilized by first planting beachgrass, or spreading brush and other mulching materials.

Plant Trees for Permanent Control

Trees are necessary for permanent control after primary stabilization and will usually produce an income from various forest products. Such areas, properly stabilized, also benefit wildlife by providing good cover and some food.

Trees planted in open sand have little chance of survival. (Fig. 14-1.) The movement of the sand by the wind either buries them, uncovers the roots, or sandblasts them until they have little resistance to insects and disease.

Start with Beachgrass

Planting beachgrass is the cheapest and most effective method of sandblow stabilization. The beachgrasses are tough, coarse, erect perennials with hard,

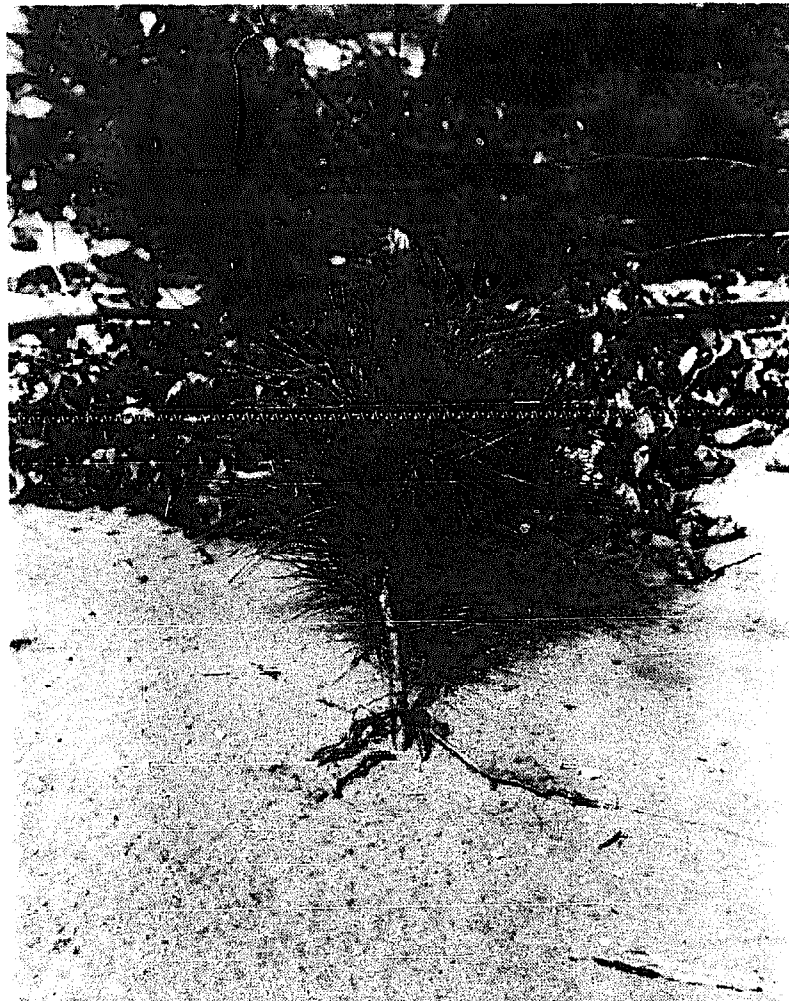

(Photo: U. S. Forest Service)

Fig. 14-1. Red pine 3 years old planted in blowout. Roots exposed by severe wind erosion.

scaly, creeping underground stems (rhizomes). They produce heavy growth on unstable beach sand of low fertility. The capacity of beachgrasses to provide initial stabilization on shifting dune areas and the rapid accumulation of organic matter from their leafy foliage are outstanding qualities.

The coarse stems which project above the surface provide a mechanical effect against sand movement and are tough enough to resist scouring. The grass grows rapidly—2 feet or more in a single season—through heavy deposits of sand. The stems multiply rapidly from underground buds so that large clumps soon are formed. The root system develops extensively and in some cases underground stems grow horizontally into unvegetated areas and produce new clumps.

Permanent grass or trees should be the ultimate goal, but the beachgrasses are unexcelled for the special purpose of initial sand stabilization.

Select Plants From Existing Stands

Since beachgrass does not produce seed readily, it must be planted by selecting plants from existing grass stands. Healthy plants 2 to 3 feet high should be dug and the roots protected from drying by heeling in or covering. In planting, use clumps of 2 or 3 plants and set them 6 inches deep. Firm the sand around the roots (Fig. 14-2).

Space Closely

By spacing the clumps closely immediate stabilization can be achieved. (Fig. 14-3.) Close spacing is used in very active sand or where buildings, roads, drainage ditches, or other crops or structures are threatened. For this type of protection, space the clumps 18 by 18



(Photo: U. S. Soil Conservation Service)

Fig. 14-2. Planting beachgrass for sand stabilization in Ottawa County, Michigan.

inches both ways starting from the windward side. About 15,000 clumps per acre will be needed.

On large sandblows, scattered or "skeleton" planting reduces the cost but requires more time for complete control. (Fig. 14-4.) On the average about 1,200 clumps per acre are needed. Patterns vary from wheel to lattice shape, depending on the shape of the sandblow. Plant first on the windward side, using a close spacing. On the rest of the area, bands of 2 or 3 rows each can be planted 20 to 40 feet apart. The grass clumps should be spaced 18 by 18 inches in the bands.

2. Planting Trees

Plant trees after the beachgrass has stopped sand movement but before the growth is too thick. (Fig.

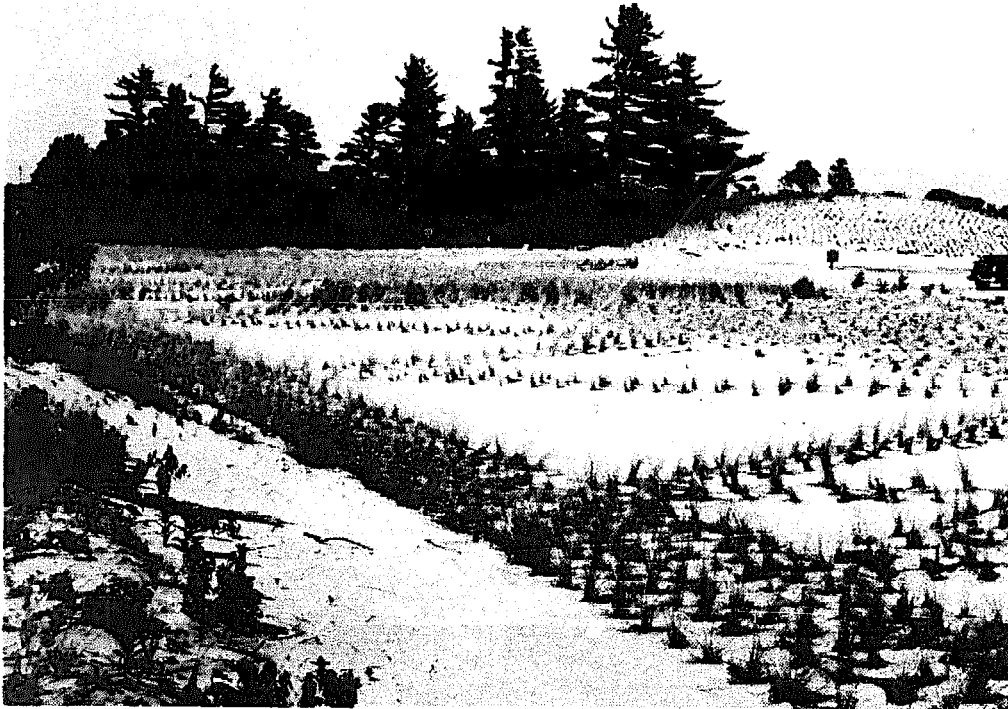

(Photo: U. S. Soil Conservation Service)

Fig. 14-3. Close spacing of the clumps provides immediate stabilization.



(Photo: U. S. Soil Conservation Service)

Fig. 14-4. Skeleton planting on large areas is less costly but takes longer for stabilization.



(Photo: U. S. Soil Conservation Service)

Fig. 14-5. Plant trees after the beachgrass has stopped sand movement but before the growth is too thick.

14-5.) This will usually be 2 or more years after the grass is set. Use hardy pines such as jack, Scotch or pitch and well-rooted seedlings or transplants in order to compete with the grass.

Another method of sandblow stabilization is by the use of brush (Fig. 14-6), placed on small sandblows or where beachgrass is unobtainable. This consists of covering the bare sand with any reasonably durable material, like cornstalks or brush. The butts should be laid toward the prevailing wind, the tops of each layer overlapping the butts of the preceding layer. Brush is effective for about 5 years. It adds humus to the sand and there is no root competition with newly planted trees.



(Photo: U. S. Soil Conservation Service)

Fig. 14-6. Use of brush on sandblows where beachgrass cannot be obtained.

Cornstalks, straw, gravel and other materials may also be used.

Rye, planted in late summer, will help stabilize small sandblows. A cheap method of stabilization adapted to small blow-outs is to mulch with straw and then roll well with a subsurface packer or a dull disk to give a stubble-mulch effect. The trees are planted immediately afterward in cleared spots in the mulch.

Chapter

XV

PLANTING SHELTERBELTS

A windbreak is generally accepted to mean one or more rows of trees planted to act as protection to a farmstead. Shelterbelts, on the other hand, are planted for the purpose of protecting fields from destructive wind damage. (Figs. 15-1 and 15-2.) They may often extend over an area larger than a single farm.

From these definitions it may be seen that windbreaks are not exactly soil conservation practices even though they add to the livability of the farm home. For example, a study by the Lake States Forest Experi-

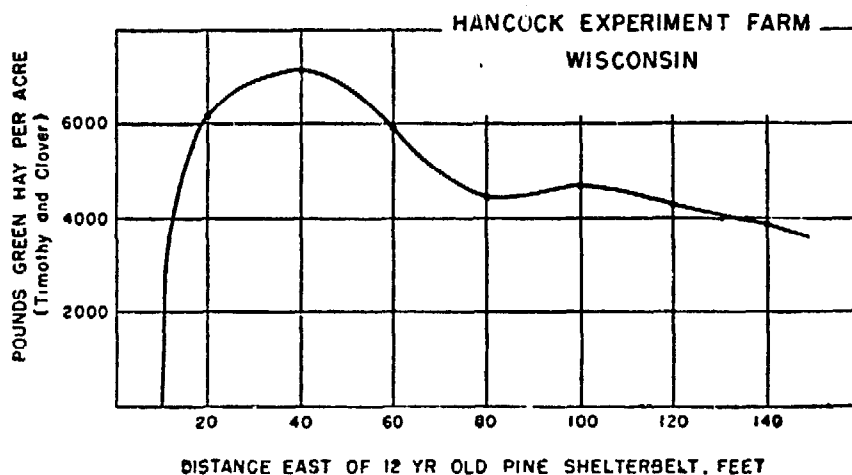
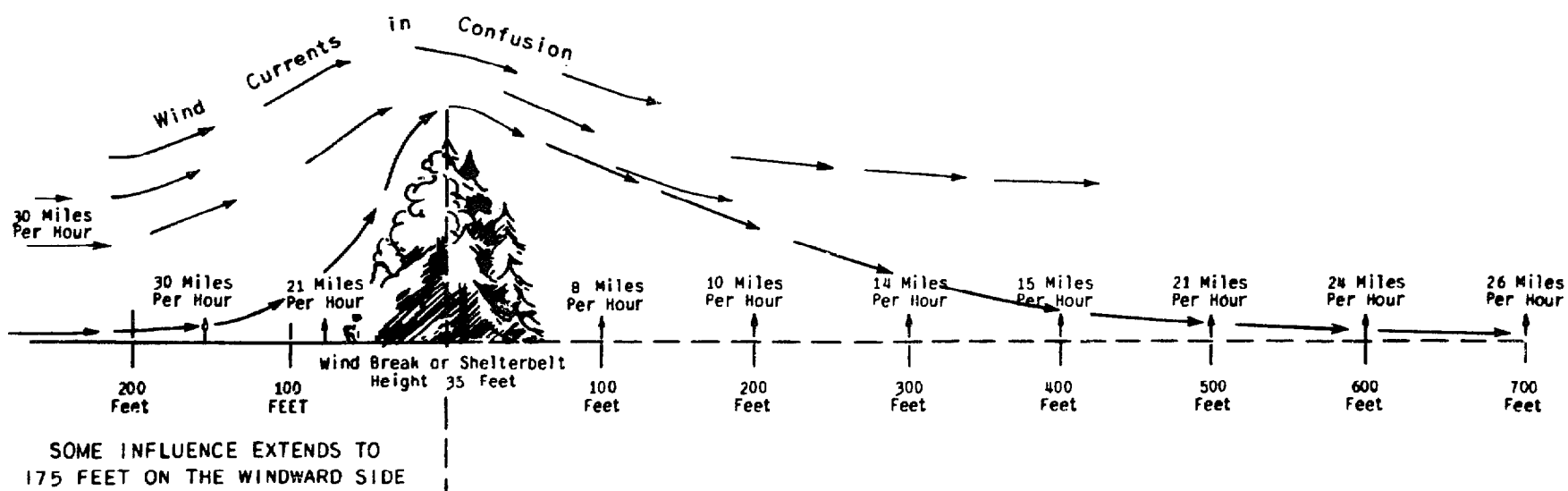

Fig. 15-1. Effect of shelterbelt on timothy and clover meadow in central Wisconsin.

EFFECT OF TREE PLANTINGS ON WIND VELOCITY



SOME PROTECTION WILL EXTEND TO 1500 FEET ON THE LEEWARD SIDE

BASED ON DATA FROM THE FOREST SERVICE

Fig. 15-2. Windbreaks break up the surface wind currents which otherwise would sweep the ground without obstruction. They provide some protection on the windward side but the greatest protection occurs on the leeward side. From Soil Conservation Service Technical Publication 115.

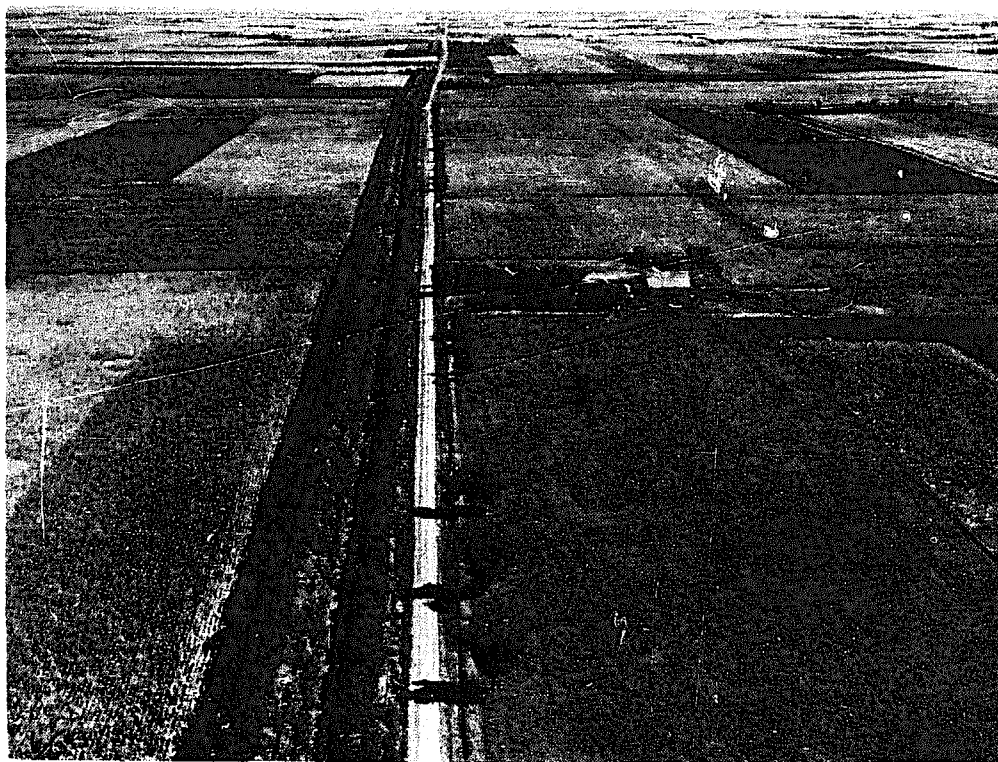

(Photo: U. S. Soil Conservation Service)

Fig. 15-3. Field shelterbelt planted to protect crops on north from hot summer winds, Seward County, Nebraska.

ment Station in North Dakota showed that a wind-break on the north side of a farm home reduced fuel requirements about 25 per cent.

Progressive farmers and orchardists plant shelterbelts for two primary purposes—to control soil blowing and to protect crops. Some southern Great Plains cotton planters find it necessary to replant two or three times on unprotected fields. Sugar-beet farmers on sandy, irrigated fields in the West frequently have a crop cut off by drifting sand. Small grain and corn farmers have had similar experiences. Orchards are subject to the same damages, but the greatest benefits are realized from protecting the trees during the pollination stage and preventing wind damage to the ripening fruit.

Planting Trees

The techniques involved in planting trees for wind-breaks and shelterbelts are not radically different than for other kinds of field planting: however, species, size of stock, ground preparation, and spacing are somewhat different. Except where there is danger from wind erosion, complete breaking of the ground in the fall before planting is recommended. Regular cultivation after the trees are established is essential for good survival and growth.

Inter-plant When Young

A good practice is to plant a couple of rows of corn or a row of sunflowers between the rows of newly planted trees. This provides for making efficient use of the land, cultivating the trees, and partially protecting the young trees from the hot sun and winds, which may be desirable for young conifers.

Plant Adapted Trees

Conifers, because they give year-round protection, are used more widely than hardwoods and in larger sizes than in field planting. However, many hardwood species are suitable and have been used widely in shelterbelts.

According to U.S.D.A. Yearbook of Agriculture TREES, the following species are recommended for different parts of the country:

In the Corn Belt region of North-Central United States, the trees that have proved adaptable are green ash, American elm, black locust, honey locust, hardy catalpa, black walnut, the Russian-olive, red-bud, honeysuckle, Norway spruce, white spruce, Black Hills spruce, red pine, and white pine. In areas



(Photo: U. S. Soil Conservation Service)

Fig. 15-4. Field shelterbelt in North Dakota six years after planting. Close-growing shrubs on both inside and outside rows protect the trees from filling with dead weeds blown by wind.

with considerable moisture, the golden willow, green willow, and native cottonwoods are recommended.

In southwestern United States, the citrus-growing sections of Arizona, New Mexico, and California, eucalyptus (sometimes known as bluegum) has been used most satisfactorily to protect citrus groves. In California, Monterey cypress has been used to some extent, while in Arizona and New Mexico, the Arizona cypress is planted occasionally with success.

In the New England States, New York, and Pennsylvania, the planting is usually confined to the farmstead windbreaks, and conifers are favored, including Norway and white spruce, white pine, and red pine.

In the southeastern part of the United States from Georgia westward to eastern Texas, there is occasionally an area of sandy soil that requires protection from wind erosion. Under such conditions the

native pine species, especially loblolly pine, makes a satisfactory quick-growing shelterbelt.

Main shelterbelts should be spaced 40 rods apart although local conditions vary enough that this spacing may vary. If needed, single rows of trees, or more, may be spaced between the main belts at intervals of 10 to 20 rods. This may be necessary where the wind has a wide sweep. These intermediate belts can be made up of any of the following:

- (a) Single rows of evergreens, 20 rods apart.
- (b) Spirea or bush honeysuckle, 3-foot spacing, rows 150 feet apart.
- (c) Willow cuttings, rows 200 feet apart.
- (d) Double rows of corn or sunflowers 80 feet apart.

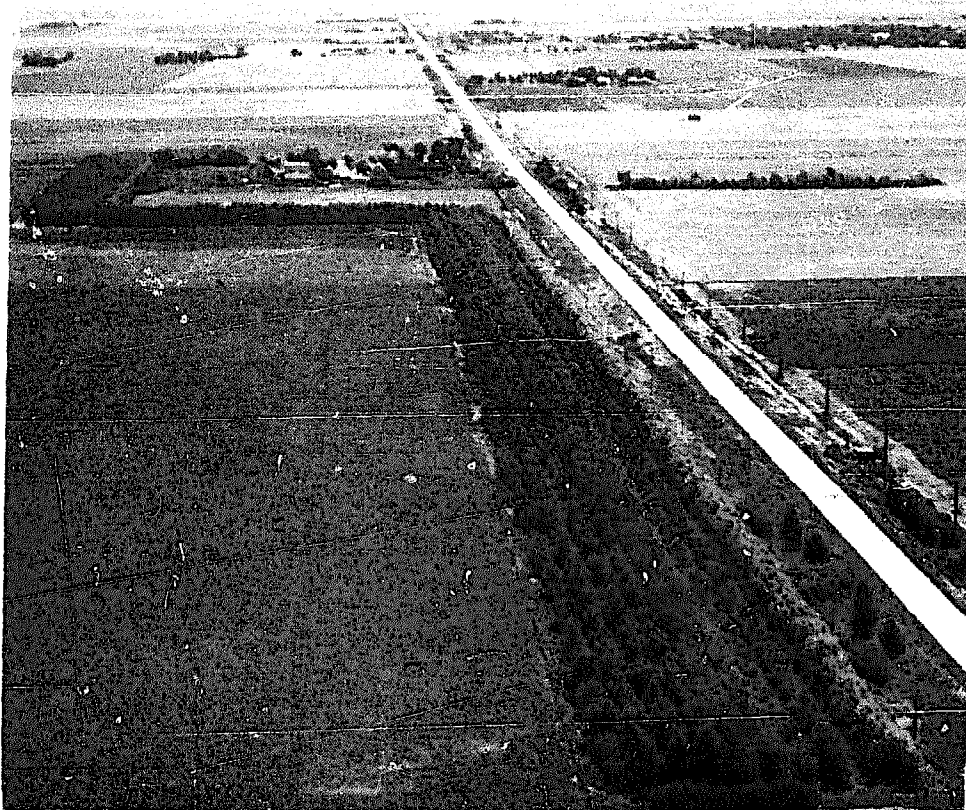

(Photo: U. S. Soil Conservation Service)

Fig. 15-5. A 10-row $\frac{5}{8}$ -mile-long shelterbelt planted to combine field and farmstead protection, Nebraska.

Rows in the main belts should be 8 to 10 feet apart with the trees 10 to 14 feet apart in the rows.

Combine with Shrub for Compact Barrier

In the drier parts of the United States one of the most important requirements is a tight row of shrubs on the windward side. Shrubs should be combined with conifers, low, medium and tall trees, to produce a compact barrier. Five rows represent the minimum that should be used when maximum protection is needed; seven rows are better. There are exceptions, of course. In the citrus-growing sections of California and the Southwest, one- or two-row plantings of eucalyptus or cedar give good results. In areas of better rainfall or where experience has shown that narrow belts will



(Photo: U. S. Soil Conservation Service)

Fig. 15-6. 10-row shelterbelt in Osborn County, Kansas. Consists of Russian-olive, red cedar, ponderosa pine, burr oak, hackberry, green ash, honey locust, Chinese elm and osage orange, planted 8 feet apart.

survive (for example on the muck soils of Indiana) single row plantings of willow are satisfactory. On the sandy soils of Central Wisconsin, three-row belts, preferably of red and jack pine, are recommended. Recommendations of State Forestry Extension specialists should be consulted for the number of rows and spacing recommended.

Guard Against Snowdrifts

Unwanted snowdrifts may result from windbreaks growing too close to farm buildings and roads. In any locality, trees should not be planted nearer than 2 rods windward of buildings or of the edge of a road right-of-way or lane.

It is important to keep hardwood trees and shrubs at least 50 feet from the tile lines on mineral soils.

survive (for example on the muck soils of Indiana) single row plantings of willow are satisfactory. On the sandy soils of Central Wisconsin, three-row belts, preferably of red and jack pine, are recommended. Recommendations of State Forestry Extension specialists should be consulted for the number of rows and spacing recommended.

Guard Against Snowdrifts

Unwanted snowdrifts may result from windbreaks growing too close to farm buildings and roads. In any locality, trees should not be planted nearer than 2 rods windward of buildings or of the edge of a road right-of-way or lane.

It is important to keep hardwood trees and shrubs at least 50 feet from the tile lines on mineral soils.

Chapter

XVI

MANAGING FARM WOODLANDS

Proper management of farm woodlands is good soil conservation since conservation implies the wise use and management of all the land. Not only will proper management of woodlands make them produce more—it will provide protection to the land on which they grow. If there is land on the farm that is best suited to the growing of trees, then good tree management must be applied if the highest income is to be derived from each part of the farm. Tree products are a crop and their production is of economic importance to the farmer.

A Suggested List of Activities Involving Approved Practices

1. Improving the Woods
2. Pruning Trees
3. Planting Trees
4. Handling Planting Stock
5. Setting the Trees
6. Protecting Trees
7. Measuring Standing Timber

1. Improving the Woods

The improvement of existing woodlands is an im-

portant part of woodland work. If woods areas, especially hardwoods, have been grazed, the first thing to do is to provide complete protection from livestock. This will do more toward improving the woods than any other single step. Also, little cutting of any kind should be done until an accumulation of leaf litter has restored something approaching natural forest soil conditions.

In woods that have been protected from grazing much improvement can be made by carefully selecting the trees to be cut so that the trees that are left can be expected to produce a good crop in the future. Figure 16-1 illustrates a common situation.

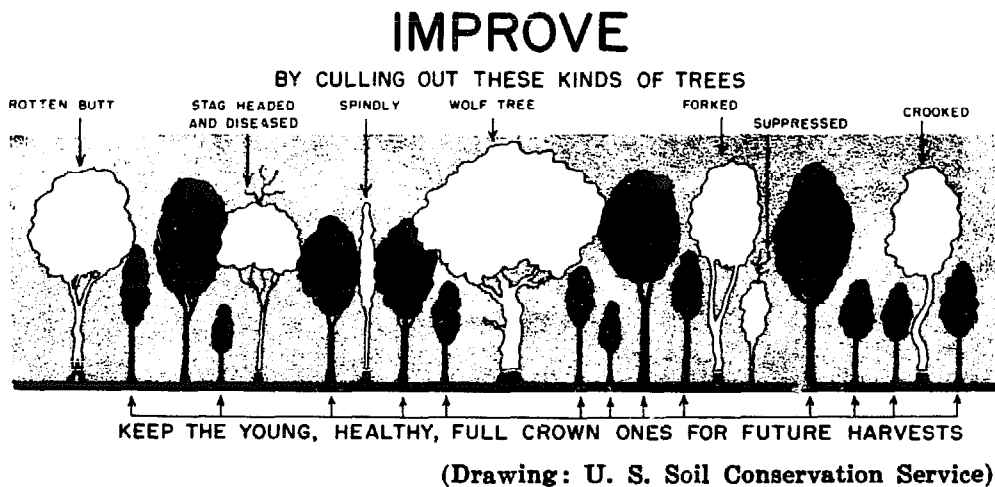

Fig. 16-1. Improve by culling out these kinds of trees.

Thin Close Stands

Contrary to the commonly held viewpoint, trees do not grow taller as a result of close spacing; in fact competition for water and sunlight may cause stunted growth. Similarly the elimination of crowding, in other words thinning, will not materially affect the rate of height growth, except in species that tolerate shade and that have been suppressed to a point where they no longer occupy a dominant place in the stand.

Use Guide for Spacing

In order that trees less than 10 inches in diameter will have sufficient growing space, the following guide will determine roughly the optimum spacing between trees: The average diameter in inches of the trees plus 4 should equal the desired spacing in feet. Thus, trees averaging 7 inches in diameter should be about 11 feet apart; if closer, thinning is needed. For trees 10 inches or more in diameter measured at breast height, the diameter plus 6 will give better spacing.

Consider Tree Height

Tree height also has been used as a guide to thinning, the rule being that for best growth the space between trees should have the following relation to height:

Tolerant trees

(can tolerate shade).....1/6 of total height

Intermediate trees1/5 of total height

Intolerant trees1/4 of total height

Applying this rule-of-thumb to a plantation of jack pine 40 feet in height would indicate a spacing of about 10 feet between trees. (Fig. 16-2.) Jack pine is intolerant of shade.

2. Pruning Trees

Pruning will also help to increase the future value of standing trees. The main purpose of pruning forest trees is to remove the side branches so that wood subsequently formed will be free of knots. (Fig. 16-3.) In the natural forest, most trees grow close enough together so that the lower limbs fall off, thus pruning themselves. Therefore pruning is not ordinarily necessary. Where trees have been planted by man natural pruning is slow and pruning may be necessary.

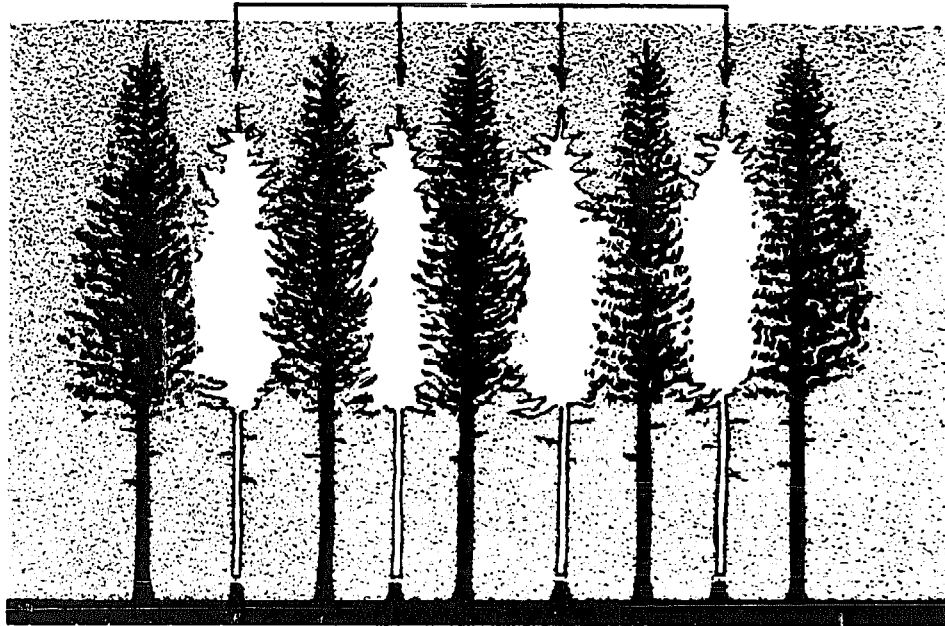
THIN, IF TOO CLOSE

(Drawing: U. S. Soil Conservation Service)

Fig. 16-2. Thin stands that are too close.

PRUNE OFF SIDE BRANCHES OF BEST ONES

(Drawing: U. S. Soil Conservation Service)

Fig. 16-3. Pruning helps improve value of standing timber.

The following general rules may be followed in pruning forest trees:

1. Prune only pines and possibly spruces which are being grown for the production of high grade lumber. It is doubtful if pruning jack, Scotch, pitch or Virginia pine or species grown for pulpwood or railroad ties is worth while. Pruning of hardwoods is also questionable because of the danger of heart rot. Even if such danger did not exist pruning may not be economical except to improve the form of an occasional select tree.
2. Pruning should be accomplished in two operations, the first when the trees are not less than 3 and not more than 5 inches in diameter, at which time all the lower branches are cut off to a height of about 6 or 7 feet; the second several years later when the trees reach a diameter of 7 or 8 inches, at which time the remaining side branches up to a height of 15 to 17 feet are removed. If the first pruning is delayed until the trees become too large, there will not be sufficient clear material laid on to pay for the increased labor of cutting the large branches.
3. Pruning should be done with a saw and the cut made as close as possible to the trunk. Do not use an ax or other tool which does not make a clean cut.
4. Do not remove more than the lower one-third of the live branches from any tree.
5. Do not prune more than 150 to 250 trees per acre. Select only those that show promise of developing into sound, healthy crop trees.

Removal of Vines

In addition to thinning and pruning, the removal of vines will also improve the farm woods. Wild grape,

poison ivy, Virginia creeper and trumpet vine are a serious menace to growing trees. Wild grape has a marked capacity to sprout, and the mere cutting of the vine does not insure its destruction. Where woods are thick, cutting in late June or early July will eliminate the plant because the sprouts will not develop in complete absence of sunlight. In most farm woods, however, there is enough light to let sprouts grow and several cuttings will be necessary for complete killing. Pulling the roots with team or tractor will help.

3. Planting Trees

The purpose of planting forest trees is to help Nature in reestablishing a complete cover of trees and shrubs. Good planting will, therefore, result in establishing in a few years a community of woody plants which might otherwise take 20, 30 or even perhaps 50 years.

Planting includes the answers to the following questions: Where to plant? What to plant? When to plant? and How to plant? The information on planting in the following paragraphs is taken largely from the Yearbook of Agriculture TREES in the chapter on care of the small forest:

Where to Plant

1. Plant trees on land that has little or no other use on the farm. Areas that are too small for growing crops are often used to grow a few trees that will be valuable for home use.
2. Understocked or sick forest areas that are not reseeding naturally can be planted.
3. Small forests that have been cut over and that are not reseeding satisfactorily should be planted.

4. If land has been cut up or ruined by erosion, the forest-tree seedlings will often hold it in place and produce a valuable crop in years to come.
5. If a small forest is filled with trees of no value, such as scrub oak or other worthless varieties, it can be torn up with land-clearing equipment and planted with trees that will have a future value.
6. Often the worn-out, rocky, or hilly land on a farm can be planted to trees, not only for the protection they afford the land, but to provide a home for wildlife, to beautify the farm, and to grow a few fence posts or timbers for home use. Land that has been abandoned or considered useless will often grow a crop of trees.

What to Plant

This question should be answered on a local basis. Look around to see what kind of trees are growing best and plant that kind on your land. It is good business to plant trees that grow and develop fast although a fast-growing tree that will not produce a saleable product should not be planted. Advice from local foresters and soil conservation technicians should be sought with this question.

Ordinarily hardwoods need better soils than conifers. They need plenty of water and if the soil absorbs water readily so the roots can get it without difficulty, hardwoods will do well. Hardwoods grow best in deep, loose, crumbly type of soil where the roots have plenty of room to develop and where the subsoil is of a type that permits good root development.

Conifers often will grow in soils that are unsuitable for the hardwoods and where the available water is less than that required by hardwood seedlings. Conifers need less care after planting. For these reasons conifers are often the best species for wornout, heavily gullied

fields, abandoned pastures, sandy areas, and areas where the soil is heavy or has a tendency to be cloddy or has a hardpan underneath.

Some general suggestions on the important species to plant if you live in the South:

1. White pine at most elevations in the mountains.
2. Loblolly pine on most soils at lower elevations.
3. Shortleaf pine in the same areas as loblolly pine, except on drier soils.
4. Slash pine on the sandy loam soils with plenty of moisture. Longleaf pine grows best on dry, sandy soil, on sandy ridges, and on sandy loam soils.
5. Walnut on good soils and on rich bottoms. Other hardwoods, such as the locusts, that are planted for fence posts grow best if planted on the better soils.
6. Yellow-poplar on good soils. In parts of Virginia, North Carolina and South Carolina, particularly the Piedmont area, Virginia pine is sometimes planted on the poorest soils. Loblolly pine, shortleaf pine and red cedar are also desirable species to plant on poor to moderate soils.

In the Southern Appalachian Mountain Region, these species can be planted:

1. Virginia pine, red cedar, shortleaf pine, and pitch pine on poor soils.
2. White pine on moderate soils.
3. White ash, yellow-poplar, and the black locust on still better soils.
4. Black locust on the best land.

If you live in the Central States a number of different species should be considered.

1. Jack pine on the poorest soils. Shortleaf and pitch pine can also be planted on some of the

worst locations. On medium soils, Norway spruce, red pine, white pine, red oak, cottonwood and white ash will grow.

2. Black walnut and yellow-poplar on the best land, and black locust on land not quite so good.

If you live in the Lake States or New England, the following species are often planted:

1. Jack pine or Scotch pine on the worst land.
2. White spruce, Norway spruce, and white pine on fairly good soils.
3. Yellow-poplar, white ash, red and white oak are suitable for the best soils.

When to Plant

Forest trees should be planted when the stock is dormant and early enough to insure root establishment before dry weather. In the northern states early spring is the most acceptable planting season. If planted in the fall, the alternate freezing and thawing of the soil causes small trees to be heaved out of the ground.

When the soil is subject to freezing, fall planting will be successful only with large stock on light, sandy soils which are continuously covered with snow throughout the winter months. Mulching around newly planted trees with straw or dead herbaceous material is used as a precaution against heaving. Oftentimes, however, this practice encourages mouse damage and, for that reason, is hazardous. Fall planting if done in the north should be completed before the first half of October, in order to permit root establishment before the ground freezes.

The approximate periods when tree planting is recommended is given on the map in Fig. 16-4. The dates, of course, are subject to yearly variations but will be found useful as a year-after-year average.

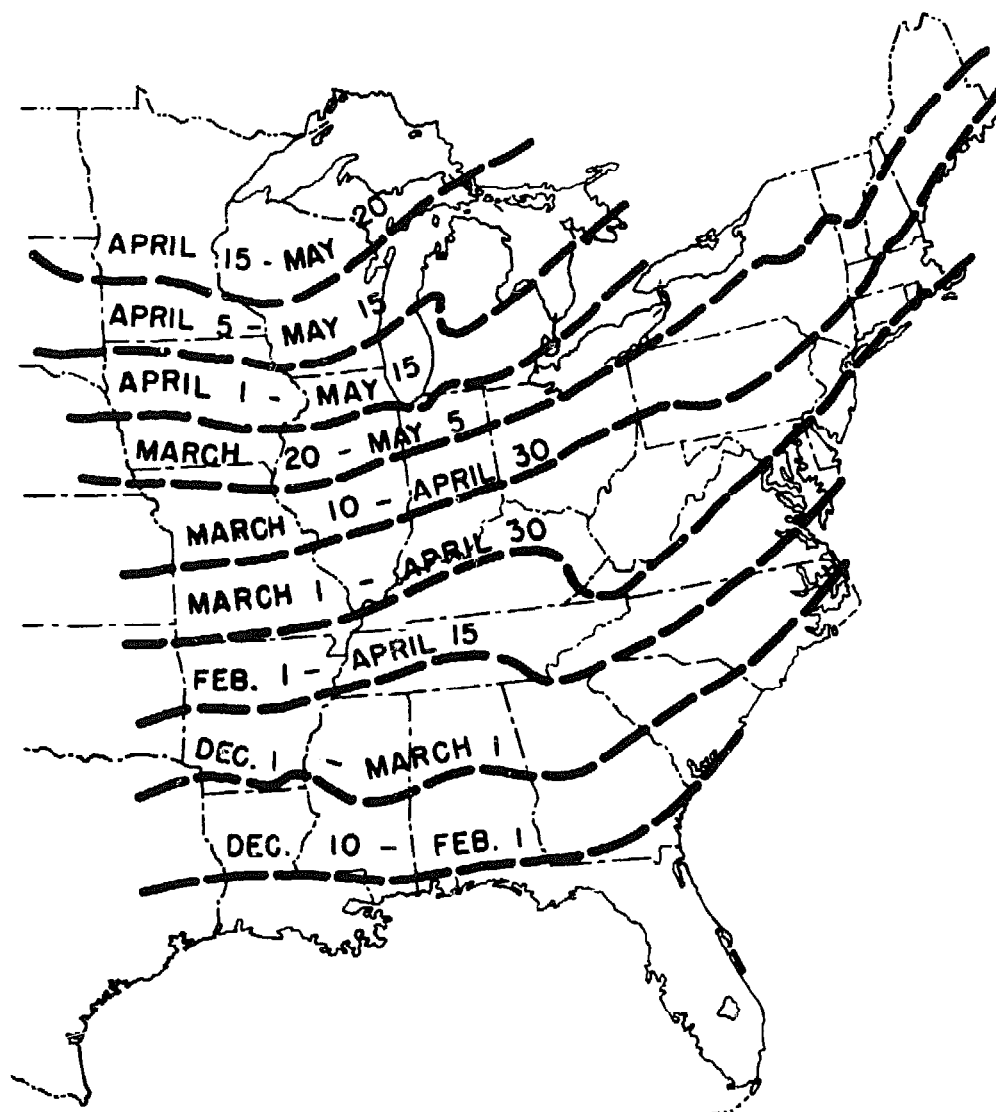

(Drawing: U. S. Soil Conservation Service)

Fig. 16-4. Approximate periods when trees may be planted in Eastern United States.

How to Plant

Probably more tree planting failures can be attributed to careless handling of stock and improper planting than any other cause. All of the steps listed below should be carefully followed if successful planting is to be assured:

4. Handling Planting Stock

1. Always keep roots moist. Drying of the fine root hairs of conifers results in hardening of the resin and consequent inability of the tree to grow.
2. Trucks hauling stock should be supplied with tarpaulins for covering the trees.
3. Avoid piling stock too deep, which will result in heating. Treetops, particularly of the evergreens, need aeration.
4. Do not permit the roots of nursery stock to freeze, either at digging time or in transit. Black locust, Osage-orange, black walnut, and some conifers are damaged to a point of worthlessness if exposed to temperatures below 25° F.
5. Boxed or baled stock must be removed from containers as soon as received, the bundles cut, and trees "heeled-in" in light, friable soil. (Fig. 16-5.) If the trees can be planted within a day or two after arrival, heeling-in may be unnecessary. Tightly packed stock that has roots sup-

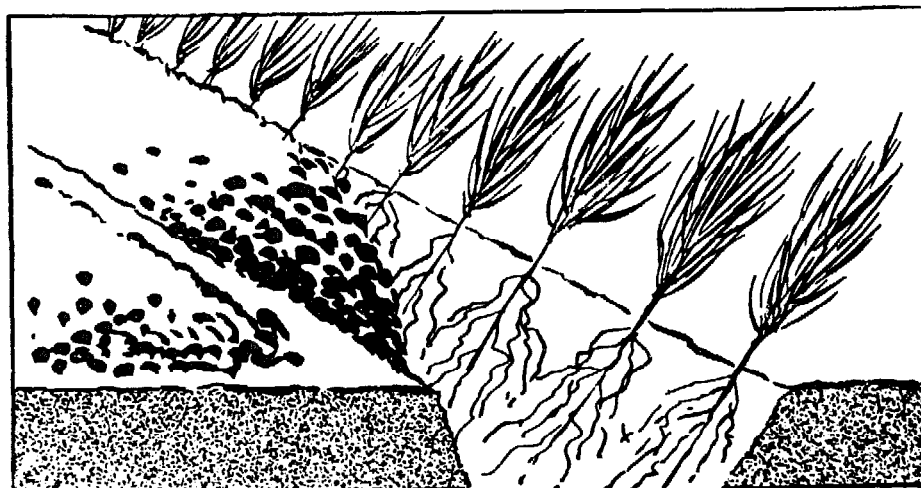

(Drawing: U. S. Soil Conservation Service)

Fig. 16-5. If trees cannot be set out within a day or two unpack them and cover their roots in a trench.

plied with plenty of moist packing material and tops exposed to the air will not deteriorate if stored in a cool place for periods up to 1 week. The essential prerequisites are good packing at the nursery and a cool storage place, such as an unheated basement or root cellar.

6. Establish heel-in beds in light or sandy soil in places protected from sun and wind, such as north slopes, under shade frames, north or east of windbreaks, woodlands, or buildings, and with the tops of the trees pointed toward the south.
7. After heeling-in, soak well with water.

Site Preparation and Spacing

1. Never plant in unprepared ground if there is appreciable ground cover. Competing vegetation is the cause of many failures.
2. Plow double furrows about 6 to 8 feet apart on the contour (Fig. 16-6), using a reversible plow, a two-bottom gang plow, or a single walking plow. The plowing should be done in the late

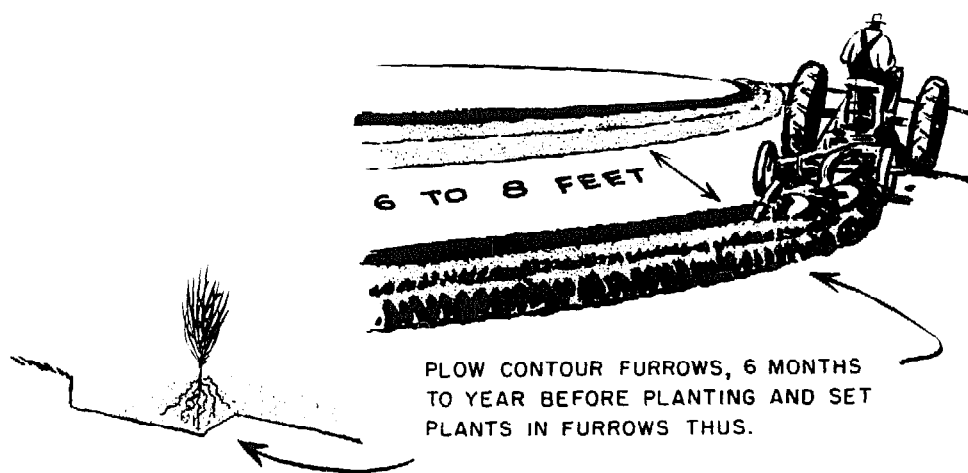

(Drawing: U. S. Soil Conservation Service)

Fig. 16-6. How to plant trees in contour furrows.

summer or early fall preceding the planting season.

3. If plowing is impractical, use a grub hoe to strip sod or ground cover from a spot 18 to 24 inches across. On difficult sites, work up the soil in the spot. (Fig. 16-7.)

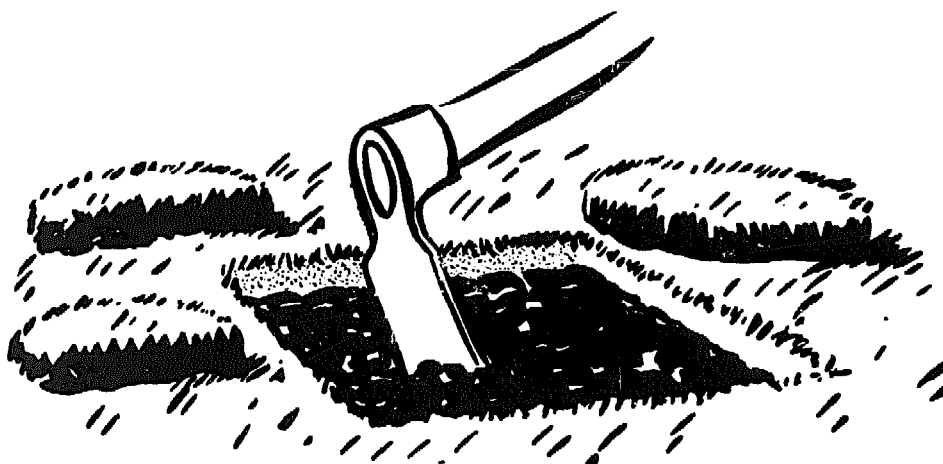

(Drawing: U. S. Soil Conservation Service)

Fig. 16-7. If plowing is impractical, strip sod off 12 to 18 inches square. In difficult sites, work up the soil within the square.

4. In field and gully planting space trees about 6 to 8 feet apart. With fast-growing species in the South and East, and where natural reproduction can be expected, trees may be spaced up to 10 feet apart. Christmas-tree plantings are spaced not less than 4x4 nor more than 6x6 feet.
5. To determine the number of trees required to plant an acre, divide 43,560 by the product of the spacing, thus: In planting 6x8 feet, 43,560 divided by 6x8, or 48, gives 907 trees per acre.
6. If the plantation is to be handled intensively, such as for Christmas trees, lanes between every sixth or seventh row of trees should be left unplanted. These lanes may be used as fire-breaks, as roadways for the movement of spray

equipment, and as places to remove products. The resulting plantation also is more productive of wildlife.

5. Setting the Trees

1. Carry trees in 12- to 14-quart pails half filled with water, or in boxes containing wet moss or shingle tow.
2. Using a grub hoe, a tile spade, a specially constructed dibble or planting bar, dig holes of ample size to receive all the roots without crowding or doubling back. (Figures 16-8 and 16-9.)

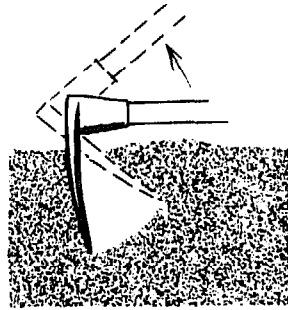

(A) DIG HOLE LARGE ENOUGH TO HOLD ROOTS.

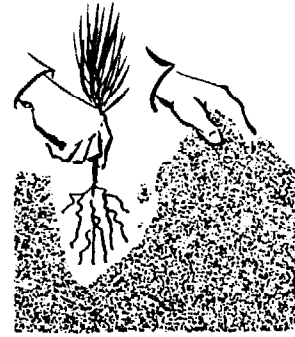

(B) SET IN HOLE AS DEEP AS TREES WERE IN THE NURSERY.

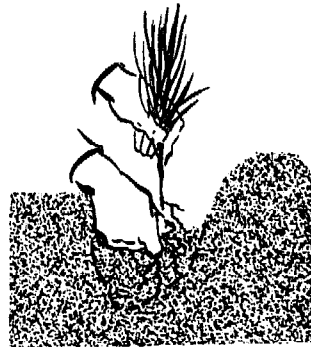

(C) PACK SOIL FIRMLY.

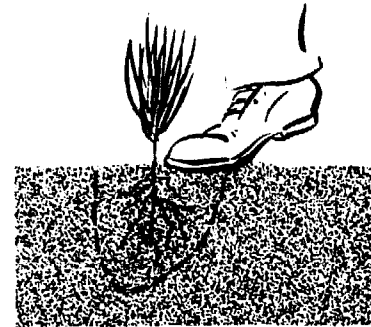

(D) PRESS AND LEVEL SOIL WITH FOOT.

(Drawing: U. S. Soil Conservation Service)

Fig. 16-8. Method of planting trees with grub hoe.

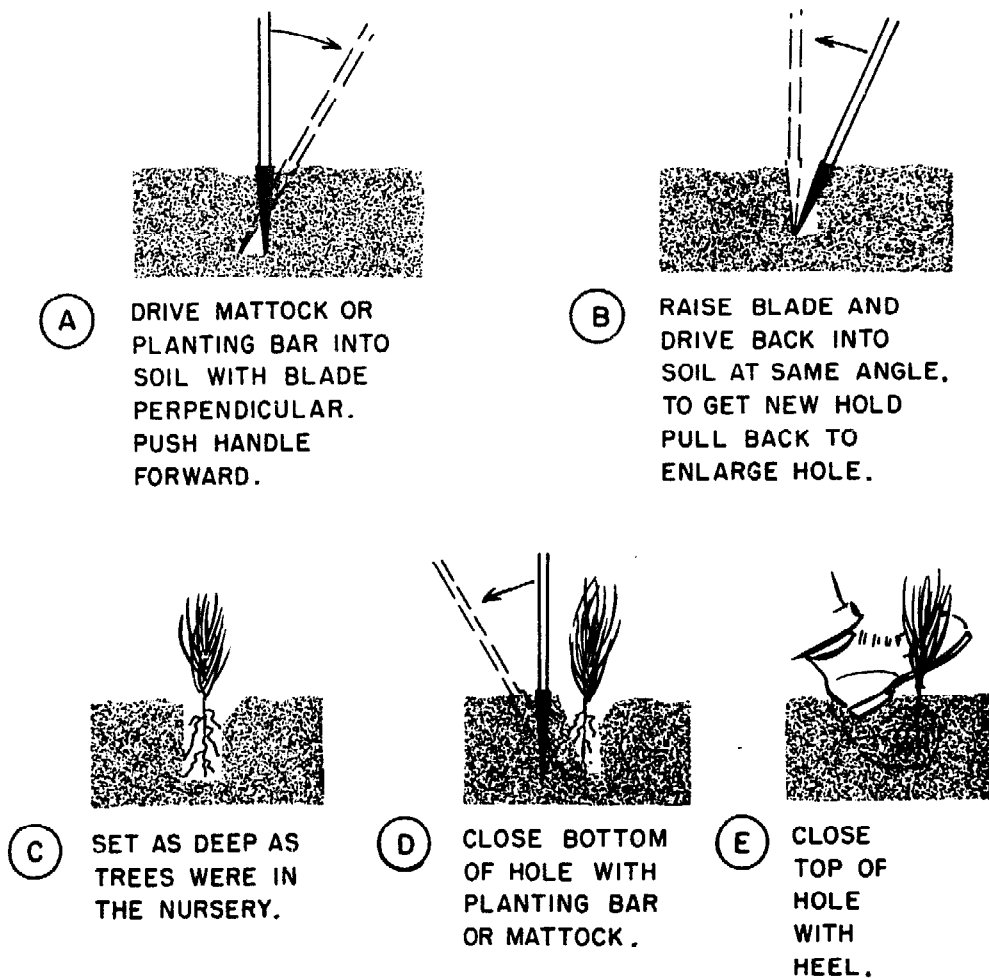

(Drawing: U. S. Soil Conservation Service)

Fig. 16-9. Planting trees with dibble.

3. Take out one tree at a time from the container and leave roots exposed no longer than necessary.
4. Set tree in hole no deeper than it grew in the nursery.
5. Thoroughly tamp loose soil around the roots; eliminate any air pockets.
6. Avoid having sod and undecomposed litter in contact with roots.

Care After Planting

1. Cultivation the first summer is necessary if

ground cover will overtop or seriously compete with trees. Do not delay until the trees are overtopped and are difficult to find. Sudden exposure of overtopped trees to the hot sun frequently is fatal.

2. In low ground where there is a rank growth of hemp, horseweeds, etc., cultivation the second summer following planting may be necessary. Merely cutting the weeds around the trees and permitting the dead tops to act as a mulch is often substituted for cultivation.
3. A good straw mulch spread in a 12- to 18-inch radius around the trees will often eliminate the necessity of cultivation, and will result in greatly increased growth. Mulch around fall-planted trees, however, often harbors rodents which will girdle and kill the trees.

6. Protecting Trees

Domestic Animals

Intensive grazing in woodland on livestock and dairy farms probably causes more damage to tree growth than any other destructive agent. Livestock browse on the leaves and shoots of the small trees, trample them underfoot, and break or deform them by rubbing or riding them down. The destruction of the young trees eliminates the possibility of any future tree crop to take the place of the older trees as they are cut or die.

Ungrazed and unburned woodland has long been recognized as the form of land use best suited to the conservation of soil and moisture on sloping land. (Figures 16-10 and 16-11.) This was demonstrated at the Soil Conservation Experiment Station at Zanesville, Ohio. The soil and water losses from three watersheds receiving an average annual precipitation of 37 inches



(Drawing: U. S. Soil Conservation Service)

Fig. 16-10. Keep livestock in good pastures, not in the woods.



(Drawing: U. S. Soil Conservation Service)

Fig. 16-11. Keep out fire.

were measured over a 9-year period. The soil and slope (14 per cent) were the same in all watersheds. Table 16-1 summarizes the results of this experiment.

Soil losses and the amount of water that runs off the

TABLE 16-1. Annual soil and water losses from land in different uses.

Land Use	Soil Loss per Acre	Water Loss of Rainfall
	Tons	Per cent
Cultivated in rotation of corn-grain-hay	17.18	20.6
Pasture, fertilized bluegrass	.10	13.8
Woodland, unburned, ungrazed second-growth	.01	3.2

(From U.S.D.A. Handbook No. 13)

land following rain were measured at the Soil Conservation Experiment Station at LaCrosse, Wisconsin, where comparisons were made in the amount of grazing. Table 16-2 gives the results of 6 years' measurements on three separate watersheds having the same soil type.

TABLE 16-2. Soil loss and runoff from watersheds with different covers.

Cover	Runoff		Soil Loss per Acre
	Inches	Per cent	Pounds
Watershed A (grazed woods)	2.31	1.17	2,126
Watershed B (protected woods)	.05	.02	19
Watershed C (open pasture)	.79	.40	866

(From U.S.D.A. Handbook No. 13)

In general the farmer uses woodland for pasture at a loss to himself. State agricultural experiment stations have repeatedly shown that forage grown in woodland is poorer both in quantity and in quality than that produced in open pasture. The Wisconsin Agricultural Experiment Station measured the total yield of dry matter from three types of pasture. The improved grass-and-legume pasture produced over 11 times, and

the unimproved open bluegrass 5 times, the forage grown in woodland. Over a five-year period the average annual yield of dry matter per acre for each type of pasture was as follows:

Renovated, grass and legume.....	3,210 lbs.
Open bluegrass, unimproved.....	1,453 lbs.
Woodland pasture	276 lbs.

It pays to fence and protect the woodland from domestic animals.

Wild Animals

Young trees, up to 10 years of age, are often damaged by wild animals of different kinds. The common field mouse is the worst offender. A small, heavily sodded area where the rodents from surrounding fields concentrate will be a danger spot. When the mouse population is heavy, which may occur every four years, and the snow is deep, every tree may be girdled. One way to prevent such losses is to turn livestock into the area for a few days before freezing weather in the fall. There will be some damage to the trees from trampling but it will be small compared with what the mice would do otherwise.

Pocket gophers may kill trees in young plantations by chewing off the roots under the surface of the ground. They can be controlled by baiting the burrows. See "Pocket Gopher Control," U.S.D.A. Farmers' Bulletin 1709.

Rabbits or snowshoe hares also will damage newly planted stands in the northern states. Trapping and hunting are the best controls.

In some areas deer and beaver may cause trouble. Local regulations should be consulted.

Birds are distinctly beneficial to trees with few exceptions.

Squirrels and porcupines may damage young stands

by eating the inner bark from the branches of living trees. Generally these losses are small. Hunting will help.

7. Measuring Standing Timber

It is helpful to be able to estimate the amount of lumber or other product a tree or area of timber will produce. There are many methods of doing this. A simple tool known as a cruiser stick, sometimes called a Biltmore stick, is very handy for measuring tree heights and diameters. Some State Extension foresters supply them through county agents. They can be purchased. Or they can be homemade by graduating any straight stick to read in diameters on one side and heights on the other. Making a cruiser stick would be a good farm shop project. The principles governing the use of this tree-measuring tool are illustrated in Figure 16-12.

If cruiser sticks are to be homemade, the maker should remember that the calibrations are dependent on the length of the arm or reach. Commercially manufactured sticks assume an arm's length as 25 inches. On the height side of the stick, the marking also will depend on the distance from the tree. See Table 16-3 for specifications for making the calibrations on a homemade cruiser stick.

After measuring the tree, the approximate number of board feet it contains can be found by the use of a table. For accurate work, the table should be applicable to the particular kind of trees being measured, and can be obtained from a local forester. However, Table 16-4 will give approximate values in board feet for trees of known diameter and merchantable lengths.

How much of the woods to measure is a question that must be decided in each situation. Unless the trees to be cut are of exceptionally high value, the timber in-

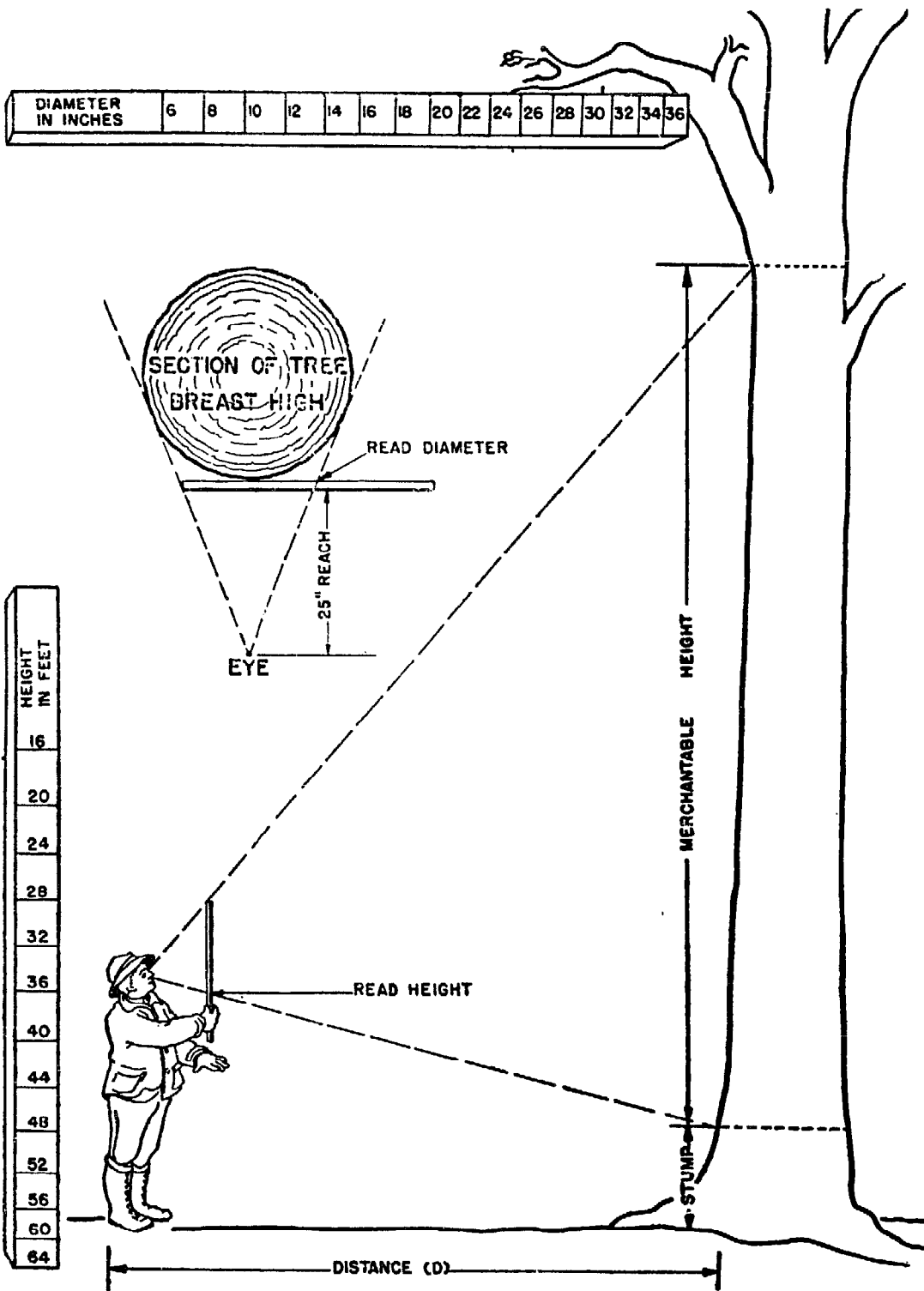

(Drawing: U. S. Soil Conservation Service)

Fig. 16-12. Illustrating the use of a cruiser stick to measure diameters and heights of standing timber.

TABLE 16-3. Markings for cruiser stick (25-inch reach).

Tree Diameter (inches)	Mark on Stick	Tree Height (feet)	Mark on Stick	
			For 60 Feet	For 66 Feet
	Inches		Inches	Inches
6	5 $\frac{3}{8}$	16	6 $\frac{5}{8}$	6 $\frac{1}{8}$
8	7	20	8 $\frac{1}{4}$	7 $\frac{1}{2}$
10	8 $\frac{1}{2}$	24	10	9 $\frac{1}{8}$
12	9 $\frac{7}{8}$	28	11 $\frac{5}{8}$	10 $\frac{3}{4}$
14	11 $\frac{1}{4}$	32	13 $\frac{3}{8}$	12 $\frac{1}{4}$
16	12 $\frac{1}{2}$	36	15	13 $\frac{3}{4}$
18	13 $\frac{3}{4}$	40	16 $\frac{3}{4}$	15 $\frac{1}{4}$
20	14 $\frac{7}{8}$	44	18 $\frac{3}{8}$	16 $\frac{7}{8}$
22	16	48	20	18 $\frac{1}{2}$
24	17 $\frac{1}{8}$	52	21 $\frac{5}{8}$	20
26	18 $\frac{1}{4}$	56	23 $\frac{1}{4}$	21 $\frac{1}{2}$
28	19 $\frac{1}{4}$	60	25	23 $\frac{1}{8}$
30	20 $\frac{1}{4}$			
32	21 $\frac{1}{8}$			
34	22 $\frac{1}{8}$			
36	23			
38	24			
40	24 $\frac{3}{4}$			

(From U.S.D.A. Handbook No. 13)

ventory most often is made by measuring and recording the trees on a number of plots selected mechanically. Then by applying the volume recorded on the sampled area to the total acreage of woodland, the gross volume can be obtained.

One man working alone can cruise a woodland if he has an outline map of the area, a compass to keep directions, a cruiser stick, pencil and paper on stiff-backed pad or holder, and can pace reasonably accurate distances. A tape to measure ground distance will be helpful in laying out each plot. However, a little practice in pacing will make this unnecessary. The scale of the map should be known, such as one inch equals 660 feet.

First determine the number of plots necessary to

TABLE 16-4. Number of board feet per tree.

Tree diameter (inches)	Merchantable height in feet										
	16	24	32	40	48	56	64	72	80	88	96
	Bd. ft.	Bd. ft.	Bd. ft.	Bd. ft.	Bd. ft.	Bd. ft.	Bd. ft.	Bd. ft.	Bd. ft.	Bd. ft.	Bd. ft.
10	36	48	59	66	73	--	--	--	--	--	--
11	46	61	76	86	96	--	--	--	--	--	--
12	56	74	92	106	120	128	137	--	--	--	--
13	67	90	112	130	147	158	168	--	--	--	--
14	78	105	132	153	174	187	200	--	--	--	--
15	92	124	156	182	208	225	242	--	--	--	--
16	106	143	180	210	241	263	285	--	--	--	--
17	121	164	206	242	278	304	330	--	--	--	--
18	136	184	233	274	314	344	374	--	--	--	--
19	154	209	264	311	358	392	427	--	--	--	--
20	171	234	296	348	401	440	480	511	542	--	--
21	191	262	332	391	450	496	542	579	616	--	--
22	211	290	368	434	500	552	603	647	691	--	--
23	231	318	404	478	552	608	663	714	766	--	--
24	251	346	441	523	605	664	723	782	840	--	--
25	275	380	484	574	665	732	800	865	930	--	--
26	299	414	528	626	725	801	877	949	1,021	--	--
27	323	448	572	680	788	870	952	1,032	1,111	--	--
28	347	482	616	733	850	938	1,027	1,114	1,201	1,280	1,358
29	375	521	667	794	920	1,016	1,112	1,210	1,308	1,398	1,488
30	403	560	718	854	991	1,094	1,198	1,306	1,415	1,517	1,619
31	432	602	772	921	1,070	1,184	1,299	1,412	1,526	1,640	1,754
32	462	644	826	988	1,149	1,274	1,400	1,518	1,637	1,762	1,888
33	492	686	880	1,053	1,226	1,360	1,495	1,622	1,750	1,888	2,026
34	521	728	934	1,119	1,304	1,447	1,590	1,727	1,864	2,014	2,163
35	555	776	998	1,196	1,394	1,548	1,702	1,851	2,000	2,156	2,312
36	589	826	1,063	1,274	1,485	1,650	1,814	1,974	2,135	2,298	2,461
37	622	873	1,124	1,351	1,578	1,752	1,926	2,099	2,272	2,444	2,616
38	656	921	1,186	1,428	1,670	1,854	2,038	2,224	2,410	2,590	2,771
39	694	976	1,258	1,514	1,769	1,968	2,166	2,359	2,552	2,744	2,937
40	731	1,030	1,329	1,598	1,868	2,081	2,294	2,494	2,693	2,898	3,103

give the desired accuracy. Decide on the size of plot and plot them on the map. The plots should be uniformly spaced and lined up so that a purely random sampling is made.

Locate a convenient starting point in the border of the woodland and with the compass determine the direction the first line of plots is to follow. Scale off the distance from the starting point to the center of the first plot on the map and by pacing or measuring along the line established mark the center of the first plot. Measure the diameter at breast height (4½ feet, known as d.b.h.) and the merchantable height of each tree growing within the radius of the plot. Keep the record in a form such as suggested in Figure 16-13.

d. b. h. inches	Species and merchantable heights																	
	Pine						White and red oak					Others						
	16	24	32	40	48	56	16	24	32	40	48	56	16	24	32	40	48	56
12																		
14																		
16																		
18																		
20																		
22																		
24																		
26																		
28																		
30																		

(From U.S.D.A. Handbook No. 13)

Fig. 16-13. One form for keeping tree measurements. Each tree is recorded by a dot or a dash in the square corresponding to its breast-high diameter (d.b.h), and its merchantable height.

Each tree is recorded by a dot or dash in the square corresponding to its breast-high diameter and its merchantable height.

After all the plots have been measured, the volumes of the trees are determined by means of a volume table. Having the volumes of the trees in the plots and the percentage of the total area the plots represent, the total volume of the woodland can be readily calculated.

Chapter

XVII

MANAGING LAND FOR WILDLIFE*

Wildlife is an essential part of the farm community. A complete soil and water conservation program on any farm will improve the living conditions for most forms of useful wildlife and the wildlife in return will benefit the conservation program.

A farm that has a favorable biological balance is one that supports useful wildlife and has a low number of harmful kinds. Examples of useful wildlife are the wild bees that pollinate the clover and alfalfa so that seed crops are produced. Other examples of useful wildlife are muskrats that live on swampy land, not fit for regular farm use, and make money for the owner who traps them. Birds that feed on insects are useful wildlife as are fish that you produce in the farm pond.

A Suggested List of Activities Involving Approved Practices

1. Discovering Wildlife Needs

*Largely from U.S.D.A. Farmers' Bulletin 2035 "Making Land Produce Useful Wildlife."

2. Managing Land to Meet Wildlife Requirements
3. Developing Drainage Ditch Banks
4. Fencing Roads and Hedges
5. Utilizing Marshes
6. Managing Waste Land
7. Managing Ponds
8. Providing Wildlife Borders
9. Protecting Streambanks

Careful studies have shown that farms under good conservation treatment have larger populations of helpful birds, beneficial insects that destroy harmful ones, beneficial small animals that are insect eaters and other helpful wildlife. Along with these kinds are the valuable game birds and animals—quail, pheasant, grouse, rabbits, squirrels, and others. So it should be kept in mind that soil conservation farming not only produces but depends on wildlife in many forms. It should also be kept in mind that wildlife furnishes recreation for the farm family. In its many forms, wildlife contributes to making the farm a more pleasant place to live.

1. Discovering Wildlife Needs

All wildlife needs food, cover and water. But it needs them in the right places. Food must be near cover that will protect the wild creatures from natural enemies and weather. Food must be there all year in some form. The critical season is winter when there are no insects or wild fruits and when the ground may be covered with ice and snow.

Plant Food Close to Cover

In the South, planting perennial food-producing plants close to good cover is the best way to be sure you have enough wildlife food throughout the year. In

the North, you can extend cover plantings close to natural food sources or leave unharvested a part of the grain crop close to good cover.

Good management of cover means about three essentials: unburned, ungrazed, unmowed grass for nesting; dense or thorny shrubs for protection from predators and for nesting; and in the North, clumps of evergreens for winter protection. All three kinds of cover should be close together and close to available food.

Wildlife gets water from three sources: surface water, food that contains a lot of water, and dew. In the East, upland wildlife can survive on sufficient foods and dew. Surface water is necessary for most wildlife in the arid West, as it is everywhere else for ducks, muskrats, mink, and other water-loving species.

In Fig. 17-1, the factors which hold down wildlife populations are shown as hurdles over which the birds must fly if they are to survive to the next spring.

Man does not control all of these factors but fortun-

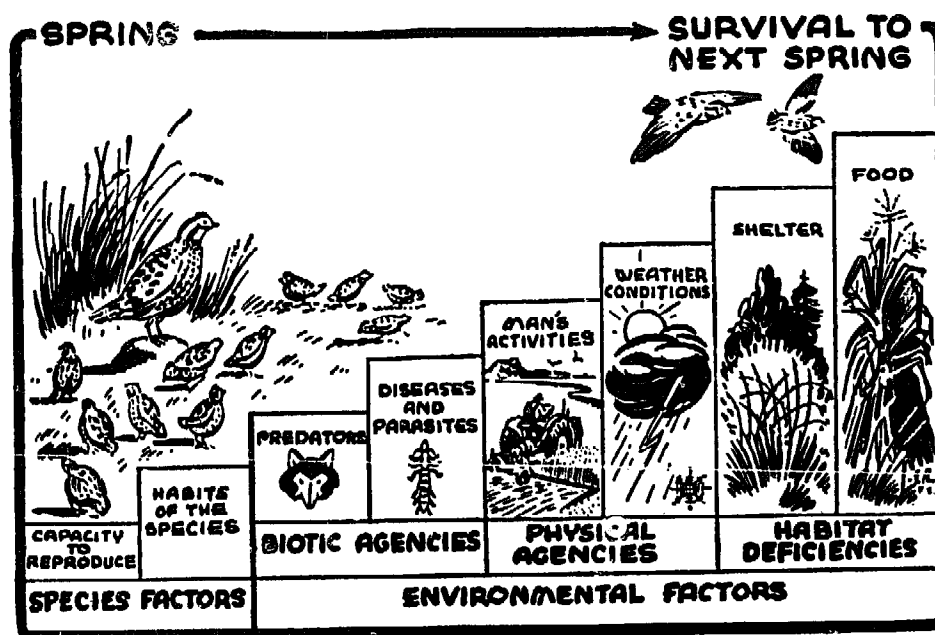

(Drawing: U. S. Soil Conservation Service)

Fig. 17-1. Factors that hold down wildlife populations.

ately he can do something about the most important ones. He can improve the amount, quality, and distribution of food, cover, and water.

2. Managing Land to Meet Wildlife Requirements

Land primarily suited for use as cropland, pasture, and woodland produces wildlife as a secondary crop. In addition, there is land on every farm that can and should be used to produce useful wildlife as a primary crop—it is wildlife land. Small areas of wildlife land well distributed over the farm, when coupled with proper use and management of other land, make the whole farm an efficient unit for the production of all crops, including wildlife.

Cropland management practices helpful to useful wildlife include:

1. Crop rotations that included grass-legume meadow.
2. Liming and fertilizing.
3. Strip cropping.
4. Use of cover crops.
5. Stubble-mulch tillage.
6. Delaying mowing of watercourses and headlands until after grain harvest.
7. Spring plowing.
8. Leaving $\frac{1}{8}$ to $\frac{1}{4}$ acre of grain standing next to good cover.
9. Spreading manure near cover in winter.

Practices harmful to wildlife include burning, clean fall plowing, early mowing of watercourses and headlands, and indiscriminate use of insecticides and weed killers.

Pasture land management practices helpful to useful wildlife:

1. Grazing within the carrying capacity of the pasture.

2. Liming and fertilizing.
3. Reseeding or renovating.

Practices harmful to wildlife include burning, grazing too heavily, and complete clean mowing early in the season.

Woodland management practices useful to wildlife include:

1. Protection from fire and grazing.
2. Selective cutting in small woodlands.
3. Leaving two den trees per acre when cutting timber.
4. Piling brush near the edge of the woods.
5. Leaving fallen hollow logs.
6. Clear-cutting of small areas in large woodlands.

Harmful practices are burning, grazing, clear-cutting of large areas, and cutting out all den trees.

Wildlife land consists of areas, usually small, that cannot be used economically to produce other crops but that are well adapted to the production of useful wildlife. Eight kinds of wildlife land are especially important. They are: Drainage-ditch banks, fence rows and hedges, marshes, "odd areas," ponds and pond areas, shelterbelts and windbreaks, streambanks, and wildlife borders. Their management is discussed on the following pages.

3. Developing Drainage Ditch Banks

Drainage ditches are good places for wildlife because they usually have water in them and food is often available on nearby cropland. By protecting the banks with a healthy growth of grass and legumes not only is the ditch maintained in better condition, but wildlife cover is provided.

The protection of the ditch bank helps keep the channel free from silt and prevents bank cutting. Grass and legumes, rather than trees, also make it easier to

clean out the ditch when that becomes necessary. Ditches full of willows may be good for wildlife but they are not good for carrying water.

Seed Banks

In seeding the banks of drainage ditches use grasses that will compete with trees. Locally adapted grasses and legumes should be used.

The ditch banks should be mowed once a year if the slopes are flat enough. Otherwise, graze them carefully or use weed killing sprays.

Mow After Nesting

Do your mowing, grazing, and weed killing only after ground-nesting birds have left the nest, usually about grain-harvest time. Don't overgraze because erosion of the banks may result.

Fig. 17-2 shows drainage ditches with poor and good treatment.

4. Fencing Rows and Hedges

The shrubby fence row offers one of the best places for wildlife and is probably the most overlooked. The wire fence, kept clean from weeds and shrubs, may look neater but is barren insofar as wildlife is concerned.

"Clean" fences have been considered necessary for controlling harmful insect pests or weeds, but this idea is losing support. Modern studies of wildlife relationships show that woody fence rows have many advantages for the farmer. (Fig. 17-3.)

Use Woody Fence Rows

Woody fence rows have been shown to harbor fewer harmful and more beneficial forms of wildlife than do



(Photos: U. S. Soil Conservation Service)

Fig. 17-2. These two pictures illustrate good and bad ditch bank management. Drainage ditches filled with trees and shrubs may be excellent for wildlife but they cannot provide good drainage for adjacent fields. Well-managed drainage ditches employ grasses and legumes to provide effective drainage for nearby fields and to produce useful wildlife.

grassy fence rows, on general farms. This may not be true on truck farms or farms producing small fruit because the fence row may harbor insects detrimental to these crops and may help to spread diseases. The danger is slight, however, if recommended spraying programs are carried out.

Woody fences fit best where a permanent boundary is used such as between cropland and pasture, along property lines and streams, or around large gullies, ponds, and odd areas. Hedges may be used as permanent contour guide lines between crop fields or on terraces and diversions.

Multiflora rose is the outstanding shrub for use in fence rows and hedges where it can be grown. It forms a living fence needing no wire and does not need trimming or pruning. It grows fast and is attractive and makes good wildlife cover as well as providing some emergency wildlife food. (See Chapter VII, Contour Fences.)

Where multiflora rose does not grow, one of the following shrubs will produce good hedge or fence row cover: Red cedar, gray dogwood, American hazelnut, bayberry, silky cornel, highbush cranberry, bush honeysuckle, autumn olive, Russian-olive, sand cherry, wild plum, trifoliolate orange, or squawbush. Local conservationists should be consulted on kinds to plant.

Farmers who do not want to grow shrubs can improve grassy fence rows with sericea lespedeza or sweetclover. Simply throw a furrow to the fence row in the fall. In late winter or early spring broadcast 30 pounds of sericea or 15 pounds of sweetclover per acre. Sericea lespedeza will grow as far north as southern Iowa, southern Michigan, and southern Pennsylvania.

5. Utilizing Marshes

Many wet marshy areas are best used to produce

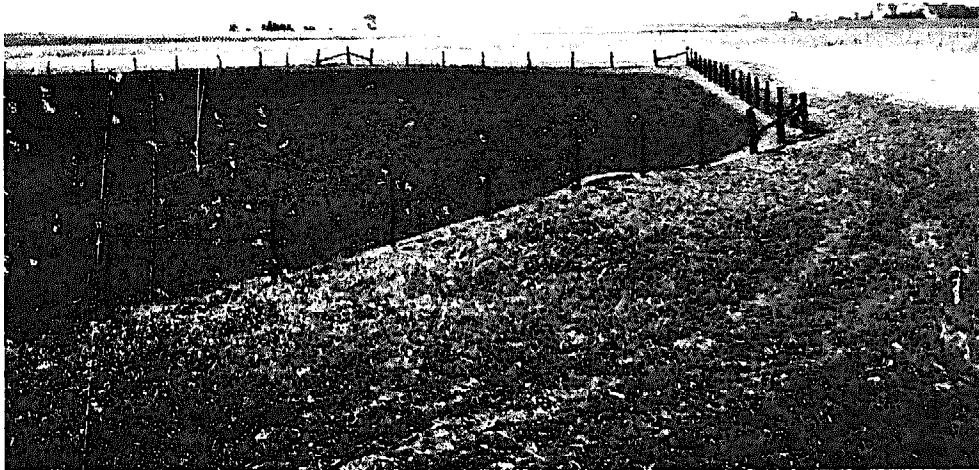

(Photos: U. S. Soil Conservation Service)

Fig. 17-3. These two photos illustrate clean fences as compared with woody fences. Wire fences offer no wildlife cover. Living fences furnish wildlife cover.

wildlife. Some of them, particularly small potholes from $\frac{1}{4}$ to 5 acres in size, located in the Northern States, are valuable producers of waterfowl. Others, when properly treated and managed, will produce an annual catch of 6 to 15 muskrats per acre. (Fig. 17-4.)



(Photo: U. S. Soil Conservation Service)

Fig. 17-4. Keeping livestock and uncontrolled fire out of marshes is good business.

Generally, marshes should be managed either for fur-bearing animals or for waterfowl. If managed for one they will be somewhat useful for the other, but it is impossible to have the best conditions for both on the same area. In either case two requirements must be met: (1) A dependable water supply and (2) the right kinds and amounts of vegetation for food and cover.

Do Not Graze

For small marshes, the simplest management is prevention of grazing and uncontrolled burning. Marsh plants make better food for muskrats and waterfowl than for livestock. Grazing destroys food and cover.

Control Water Level

Northern marshes need 6 inches or more of water for at least 3 months in spring and early summer. Where this condition does not exist, the marsh can be improved by blasting one or more holes about 30 feet in diameter and 2 to 3 feet deep.

Marshes larger than 5 acres, where the water supply is reliable, can be improved by controlling the water level. This may require a structure of some kind. An engineering survey will be necessary to find if a water-level control structure can be built at low cost.

For muskrats, control the level at about 6 inches in the summer and raise the level to about 2 feet in the winter to prevent freezing to the bottom.

To manage marsh for waterfowl by controlling the water levels, you have two choices. One is to draw the water down enough to keep the soil moist, but with no water on the surface, during the growing season. This will favor growth of smartweed, bur reed, wild millet, and other good waterfowl food plants.

Raise Water Level in Fall

The water level should be raised to about 18 inches in the fall to attract waterfowl. This method is best for the South, but it does not provide nesting for waterfowl or homes for muskrats.

The other method is to maintain the water level at depths of from 18 to 30 inches throughout the season, holding it at 18 inches in the fall. This will favor the growth of waterfowl food plants such as wild celery, pondweeds, arrowhead, duckweed and muskgrass. Some of these are also good for muskrats.

On fairly large marshes that do not have a reliable supply of surface water but that do have a water table that keeps water within a foot of the surface, you may be able to improve them with level ditches. Level

ditches should be 5 to 6 feet deep in the North, 4 to 5 feet deep in the central United States, and 3 to 4 feet deep in the South. They should be 12 to 20 feet wide and placed 100 to 400 feet apart. They must be level so that water will not flow. If they can't be made exactly level, they should be blocked at intervals.

Studies in Wisconsin have shown that ditching of peat marshes having water levels of $\frac{1}{2}$ foot in winter pays off in larger muskrat harvest.

Musk rats should be trapped heavily—you should take 60 to 70 per cent of the population each year.

6. Managing Waste Land

Small pieces of "waste" land that can be changed into wildlife land are called **odd areas**. They include small eroded areas in crop fields, bare knobs, sinkholes, small sand blowouts, large gullies (Fig. 17-5), abandoned roads and railroad rights-of-way, borrow pits, gravel pits, or even bits of good land that are cut off from the rest of the field by a stream, drainage ditch or gully. To be useful for wildlife odd areas should be at least $\frac{1}{4}$ acre in size. They may be as large as 20 acres in the West. In the East, areas of more than 3 acres could be used to produce timber crops, using only the edges for wildlife production.

Most odd areas need better ground cover and food. At least half of the area should be in good ground cover of grasses and legumes. It is a mistake to plant too many trees without leaving enough land in grasses and legumes. Good ground cover is needed for ground-nesting birds and cottontails.

In the North the center might consist of a solid clump of 25 to 50 conifer trees, spaced about 10 feet apart so that they will keep their lower limbs and keep good cover close to the ground as long as possible. The conifers should be surrounded with one to three rows

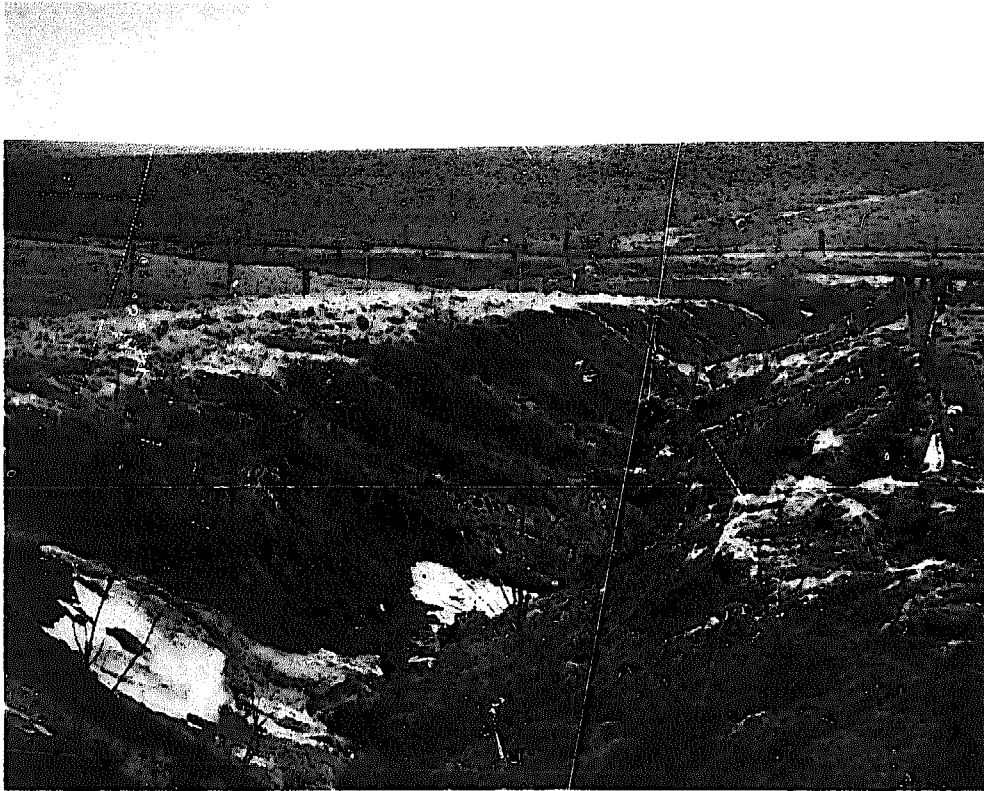

(Photos: U. S. Soil Conservation Service)

Fig. 17-5. Before and after pictures showing wildlife use resulting from fencing and planting raw gully.

of fruit-producing shrubs to provide some food and nesting cover for song birds. These could include multiflora rose, thornapple, and blackberry, all of which are thorny and would make good escape cover too. Multiflora rose would also provide emergency food for pheasants. Highbush cranberry, Russian-olive, autumn olive, gray and silky dogwoods, bush honeysuckle, bayberry, chokecherry, and wild plum are all fruit producers.

In bobwhite country an eighth of an acre of shrubby lespedeza should be used. Plant it in rows 3 feet apart with the plants 2 feet apart in the row.

The shrubs should be planted 3 to 4 feet apart to get a good thicket.

Out from the shrubs about half of the area should be left in grass for nesting cover. If the native grass is sparse tame grass mixed with either sericea lespedeza (where it is adapted) or sweet clover can be added. Don't try to get too heavy a stand—nesting birds like to be able to see what is coming their way.

The odd areas should be fenced to keep out livestock. Where multiflora rose will grow it is excellent for this purpose.

In pheasant country, pheasants can be encouraged by making the odd areas in the form of a windbreak. Plant two rows of such hardy shrubs as wild plum, sand cherry, Russian-olive, or bush honeysuckle on the west and north sides. Then sow a strip 100 feet wide to sweetclover and plant a block of at least 100 conifers or hardwood trees like green ash, soft maple, or box elder in the southwest corner. This type of planting should be at least an acre in size to provide the winter shelter and the nesting cover needed in that area.

7. Managing Ponds

The pond and the area immediately surrounding it,

make an excellent wildlife area if properly planted and managed. The water in the pond itself is important in the production of fish. It also provides water for other wildlife.

Control Erosion

Since the water supply for most ponds comes from running off land, it is important that this land be protected from erosion to keep the pond from filling with soil. The entire watershed should be in ungrazed woods or improved permanent pasture or range. Cropland in the watershed shortens the life of the pond by allowing silt to get into it. Such damage also makes the water unfit for fish.

Fence Ponds

The pond should be fenced to keep out livestock. This is important to help prevent the spread of livestock diseases; to protect the fill, spillway, and pond edges from trampling; and to provide a filter strip to remove silt from the water before it reaches the pond. Fencing also makes it possible to make useful plantings for up-land wildlife.

In areas where it can be grown, multiflora rose should be used to establish a living fence as shown in the drawing. (Fig. 17-6.) Also plant a few shrubs and conifers, using the same spacing as suggested in Chapter XVI.

Seed Raw Areas

All raw areas above water line should be seeded to adapted grasses and shallow-rooted legumes such as alsike clover, red clover, Korean or common lespedeza. Do not plant trees, shrubs, or deep-rooted legumes like alfalfa, sweetclover, or sericea lespedeza on the fill.

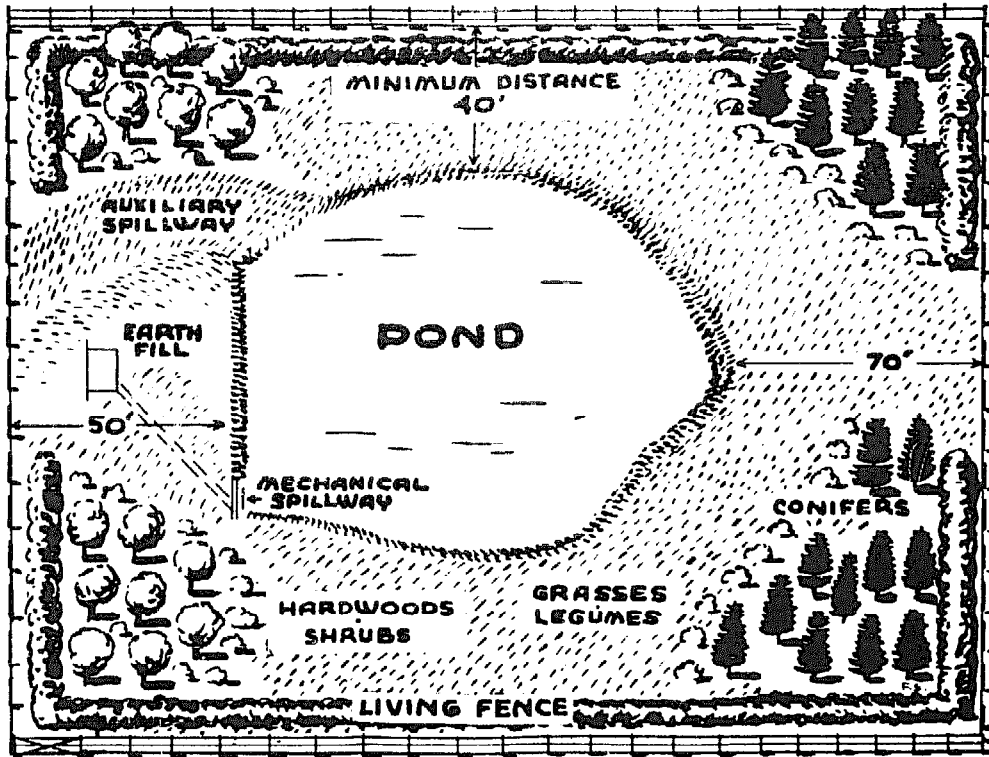

(Drawing: U. S. Soil Conservation Service,

Fig. 17-6. Planting scheme for pond area.

If the pond is to be managed for fish, nothing should be planted in the water. Keep woody plants back at least 15 feet from the water's edge to allow plenty of room for fishing.

If fish are not important, then a few cattails, arrowhead, bulrushes, and bur reeds will attract muskrats and waterfowl. These plants usually come in naturally and may become too thick in shallow water.

A pond a quarter of an acre in size will produce fish if it is fertilized systematically. Without fertilizing, it should be at least a half acre.

In the North ponds should average at least 10 feet deep, with $\frac{1}{4}$ of the pond 12 to 14 feet deep. In the Central States, ponds should average 6 feet in depth with $\frac{1}{4}$ of the area 8 to 10 feet deep. In the South, they should be at least 6 feet deep in the deepest part.

Ponds for fish production should be built so they are

3 feet deep within 10 feet of the shore line. This helps control water weeds and mosquitoes and permits bass to reduce the number of small fish effectively.

Stock with Bass and Bluegills

Farm ponds may be stocked with fish as soon as the water approaches the spillway level. For pan fish, large-mouth black bass and bluegills make the best combination. They must be stocked together because neither species is satisfactory alone. Bluegills, stocked alone, quickly overpopulate the pond with stunted fish. Bass, stocked alone, turn cannibalistic and produce a low yield. They must feed on other fish for maximum production.

In most states 50 bass fingerlings and 500 bluegill fingerlings per acre are stocked in unfertilized ponds. In fertilized ponds the stocking rate may be increased to 100 bass and 1,000 bluegill per surface acre.

Maintain Water Quality

Fish in warm water ponds grow best in water temperatures above 65° F. A pond that is intended for warm water fish can be improved by using a device on the riser to take overflow from the bottom of the pond rather than the top. This helps warm the pond early in the spring, may also save fertilizer, and may permit fertilizing in the spring when the flow is heaviest.

All animal life in the pond uses oxygen constantly. Oxygen is added to the water by surface absorption from the air and by the microscopic plants through photosynthesis. Serious oxygen deficiencies are most likely to occur when dead waterweeds or other organic materials are decomposing rapidly during hot weather or as a result of two or three successive days of windless cloudy weather. Oxygen deficiency may also occur

if summer storms with high winds cause the pond water to turn over. This mixes the oxygen-deficient water from the deep parts of the pond with surface water, thus depleting the oxygen supply.

If the oxygen level is dangerously low, fish come to the surface and gasp for air. Unless the water is treated, many may die.

Oxygen deficiency can be corrected by broadcasting 50 to 100 pounds of superphosphate per surface acre. The superphosphate stimulates the microscopic plants to give off more oxygen and reduces the effect of any carbon dioxide and ammonia that may be present. The bottom-water overflow outlet reduces the chances of die-off.

If the pond is built in areas where the soils are low in calcium, the water may be too acid for best fish growth and reproduction. Limestone at the rate of 2

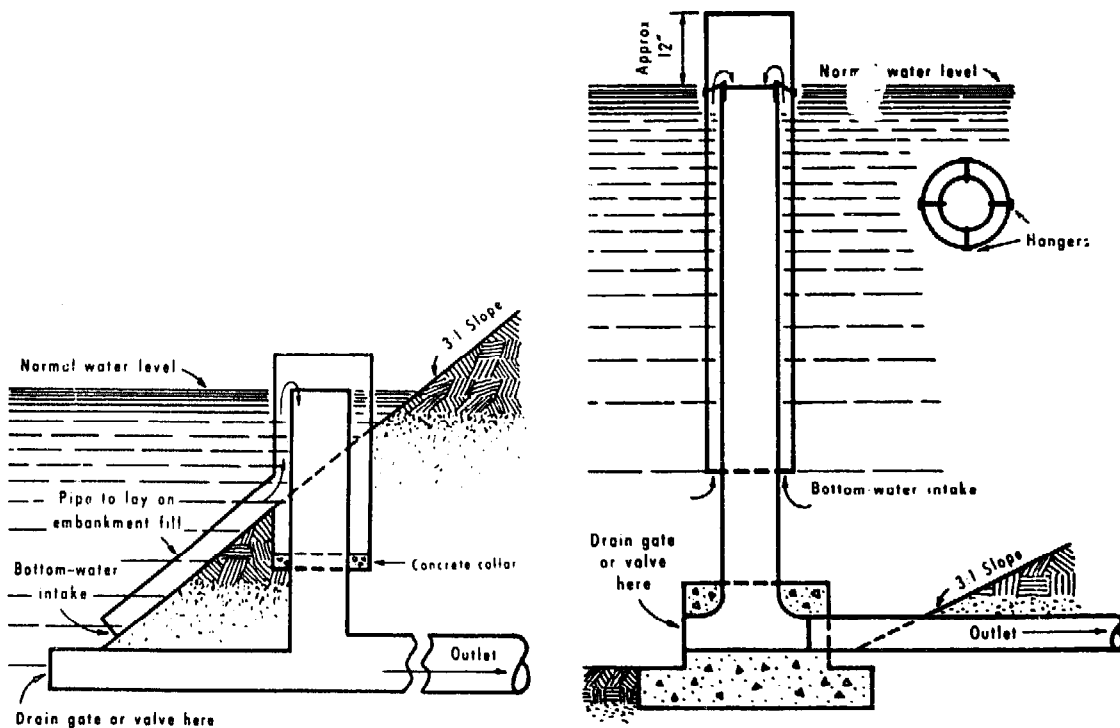

(Drawing: U.S.D.A. Farmers' Bulletin 2250)

Fig. 17-7. Designs for bottom-water overflow. Top of riser must be open.

tons per acre applied on the bottom of the pond before filling with water will prevent acidity. A 50-pound bag of hydrated lime per acre, added at the time of fertilizing the pond, will correct moderate acidity.

If the pond gets muddy after a storm, it can be corrected by broadcasting 50 pounds of superphosphate and 100 pounds of cottonseed meal per surface acre. Double these amounts if the pond is extra muddy. Of course erosion on the watershed should be controlled.

Gypsum also clears muddy water. Use 12 pounds of gypsum per 1,000 cubic feet of water (500 pounds per acre foot).

Another way to clear muddy water is to scatter hay in the water along the edges of the pond. Use 7 to 10 bales for each surface acre. Do not use hay in hot weather—its decay may cause loss of oxygen.

Fertilize Ponds

Fertilizing a pond will make it produce more fish. Fertilizer increases the growth of microscopic plants. Fish eat the worms, insect larvae, and other aquatic animals that feed on these tiny plants.

A fertile pond also hinders the growth of submersed waterweeds. The millions of microscopic plants that grow in fertile water color the water to a depth of 18 inches or more and prevent sunlight from reaching the bottom. Submersed waterweeds cannot grow without sunlight.

When to Fertilize

A new pond should be fertilized as soon as it fills with water. In old ponds it is necessary to build up the pond's fertility quickly and early in the spring. In Florida and in the southern sections of South Carolina, Georgia, and the Gulf States, fertilizing can continue the year around. Farther north, continue fertilizing



(From U.S.D.A. Farmers' Bulletin 2250)

Fig. 17-8. A testing stick tells you when to fertilize.

throughout the growing season and continue until cool weather in the fall.

One way to determine when to fertilize is to use a homemade device consisting of a white disk on the end of a stick. Submerge the disk in the water and if you can see the disk at a depth of 18 inches or more, it is time to fertilize.

Kind and Amount of Fertilizer

Each application of fertilizer should consist of 100 pounds of a complete fertilizer such as 8-8-2 per surface acre. Or use 50 pounds of 16-16-4 or 40 pounds of 20-20-5. Most ponds require about 12 applications each year.

In many ponds that have been fertilized with complete fertilizer for three to five years, the fertility level can be maintained by using phosphate alone. Use 40 pounds of superphosphate or 18 pounds of triple superphosphate per surface acre at each application. This should be done on a trial basis, and if the pond does not respond, go back to a complete fertilizer.

How to Fertilize

The easiest way to fertilize is from a platform. Place the platform about 12 inches below the pond surface near the pond edge. If the pond level fluctuates, suspend the platform beneath floats. Place sacks of fertilizer on the platform and slit them open. Add more as often as the disk test shows the need. Wave action and water currents will mix the fertilizer throughout the pond.

Fertilizer can be applied from a boat or broadcast by hand from the bank. It is not necessary to scatter fertilizer all over the pond. In fact, it is better to place it in water no deeper than 3 feet.

Control Waterweeds

Controlling weeds in ponds is necessary for good fish production. Deepening the edges of the pond and fertilizing the water are the most effective and least expensive ways to control most waterweeds.

Submersed weeds can be killed by applying fertilizer on the weed beds in winter. Fertilizing should begin in December in Florida, and in January or early February a little farther north. Apply 8-8-2 or similar fertilizer broadcast from a boat over the weed beds, using about 200 pounds per surface acre. Repeat every two weeks until there is a heavy growth of single-filament algae. The totally shaded weeds die in early summer. The whole mass floats to the top, remains a few days,



(From U.S.D.A. Farmers' Bulletin 2250)

Fig. 17-9. Placing fertilizer on a platform is an easy way to fertilize the pond.

then sinks to the bottom and quickly decomposes. This method takes four to five months but is safe and inexpensive.

8. Providing Wildlife Borders

Wildlife borders are used to control erosion around the edge of a field and to make use of these narrow strips of land on which satisfactory grain crops are hard to grow. (Figs. 17-11 and 17-12.)



(From U.S.D.A. Farmers' Bulletin 2250)

Fig. 17-10. Fertilizer can be applied from a boat.

In different parts of the United States, wildlife borders are established in one or more of the following situations: As turnrows along the edges of crop fields; in sapped areas such as those where cropland is next to woodland, tall shelterbelts, or windbreaks; along streams, ditches, waterways, gullies, farm roads; and for confinement strips to keep Burmuda grass from spreading into cropland fields.

Wildlife borders can be made up of either grasses and legumes or of shrubs and conifers.

Legume-grass borders make farming easier by providing a headland on which to turn machinery. Shrub or shrub-conifer borders protect woodlands from drying winds and prevent the loss of leaf mulch. This conserves moisture and helps trees grow faster.



(Photo: U. S. Soil Conservation Service)

Fig. 17-11. Wildlife border of sericea and shrubby lespedeza on Alabama farm.

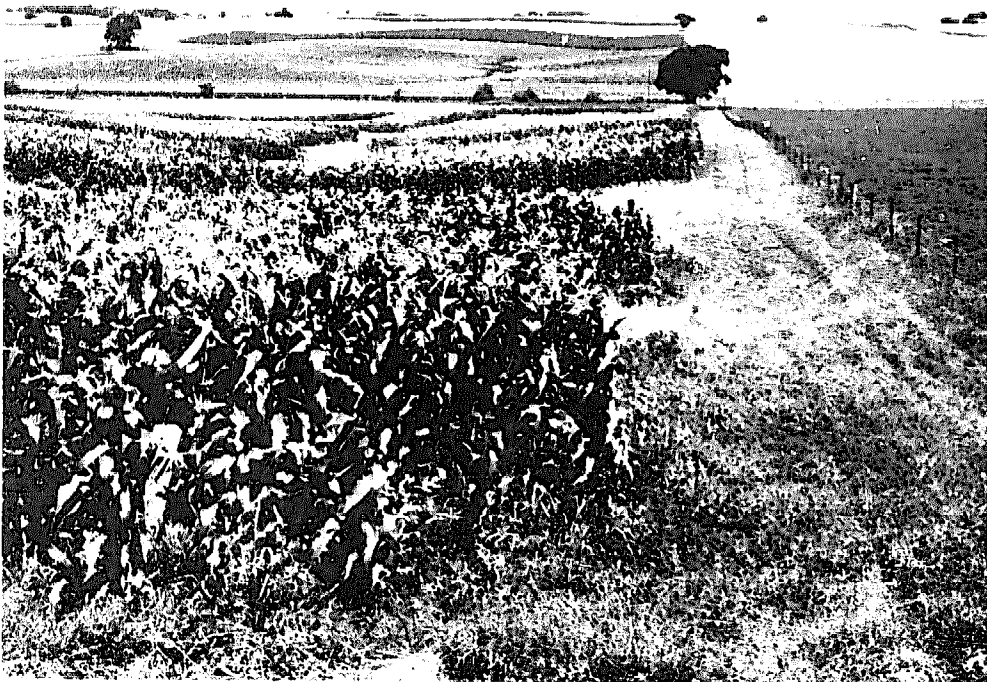

(Photo: U. S. Soil Conservation Service)

Fig. 17-12. Turn land at end of corn rows on Wisconsin farm provides wildlife cover and prevents erosion along field boundary.

Both types of wildlife borders benefit wildlife by providing either food or cover—sometimes both. The cover they furnish is next to cropland where food is sometimes available and the food they produce is often next to woodland where cover can be found.

Wildlife borders help produce more insect-eating songbirds, more game birds, and animals, and more pollinating insects.

Legume-grass borders can be established when the entire field is seeded. When the field is plowed, the borders can be left about a rod wide. They can be left indefinitely as long as a good sod remains.

These grass-legume borders should be left unmowed, since they do not take up much acreage and one of their main functions is to provide nestage cover for birds. If mowing is done for controlling weeds it should be delayed as long as possible to give the young birds time to get off the nest.

9. Protecting Streambanks

A stream with the banks protected by vegetation improves conditions for land-based wildlife because it provides food, cover, and water close together. It is also better for fish.

The most common causes of streambank erosion are: Overgrazing; fallen trees that deflect water from its normal direction of flow; trees or brush growing on the **inside** of a curve that deflect water against the cutting bank. Water from a smaller stream entering the channel may deposit sediment that pushes the water against the eroding side.

The first, and often the most difficult thing to do in treating a streambank is to protect the stream from grazing. In other words, fence it to keep out livestock.

Next, correct the causes for meandering. Remove fallen trees and trees and brush on inside curves.

Eliminate the sediment carried by small streams through conservation practices on their watersheds.

For small streams up to 6 feet wide with low banks 3 to 4 feet high and watersheds of not more than 2 square miles, protection from grazing is often all that is needed.

For medium-sized streams 6 to 12 feet wide with banks not more than 10 feet high and with watersheds of less than 10 square miles, some kind of mechanical protection is usually needed. Willow poles can be driven in on the cutting side at or just above the water line in a double row. The poles should be 2 to 4 feet apart and staggered between rows. They should be 6 to 8 feet long and 2 to 4 inches in diameter and cut from brush-type willows. Purple-osier willow is one of the best.

About two-thirds of the pole should be driven below the ground line. The poles should be supplemented by planting willow cuttings at a spacing of 2 by 2 feet, using shrub-type willow.

Another method that can be used on medium-sized streams is illustrated in Figure 17-13. On eroding curves, slope the bank to the point where there is 1-foot drop in 1-foot horizontal distance. Shingle the bank with bundles of brush-type willows, placing the butt ends below the water line. Drive willow stakes into the bank and lay willow poles across the bundles of brush. Fasten the poles to the stakes with No. 9 wire.

For larger streams a more intensive method must be used. These jobs will require the assistance of an engineer with experience in such work.

On all types of streambank improvement, much of the value for wildlife comes from the planting of shrubs and trees that can tolerate moist conditions.

Shrubs that can be used include red-osier dogwood, gray dogwood, silky cornel, Russian-olive, nannyberry, and highbush cranberry. Multiflora rose living fences

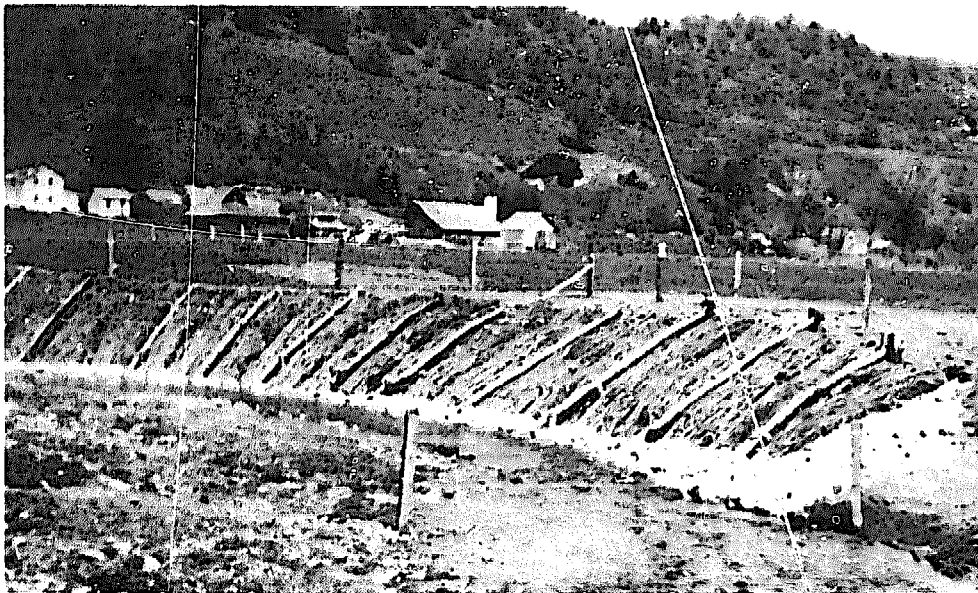
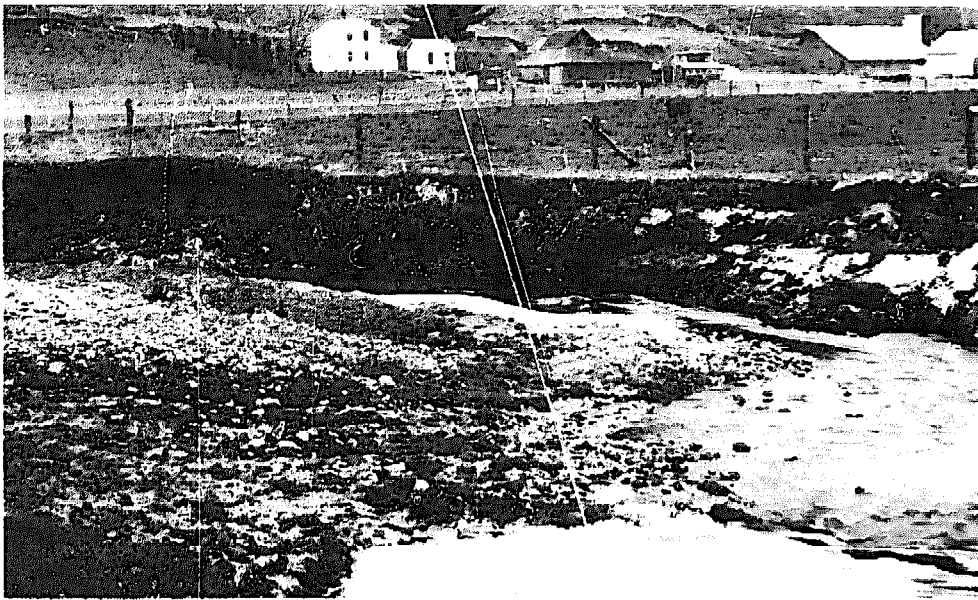

(Photos: U. S. Soil Conservation Service)

Fig. 17-13. These three photos show progressive steps in treating streambank with willows and riprapping with rock.

may be planted as a permanent fence along the top of the streambank.

White pine, yellow pine, Northern white cedar, Rocky Mountain juniper, and Norway spruce are conifers suitable for winter cover.

Chapter

XVIII

IMPROVING AND MANAGING PASTURES AND RANGES

Most experts agree that pastures and ranges have been greatly mismanaged in the past. Added income is the result of good pasture management.

A Suggested List of Activities Involving Approved Practices

1. Improving Pastures
2. Testing and Treating the Soil
3. Pasturing the New Seeding
4. Controlling Weeds by Clipping
5. Planning Range Conservation

1. Improving Pastures

Good pastures help make a conservation program work. A good well-managed pasture soaks up more water than a cultivated field with the same slope or a similar pasture that is overgrazed. The water saved means more forage and greater livestock gains. The soil loss from a good pasture is only a small fraction of that from a similar cultivated field.

Good pastures can help the woodland program on the farm by making it unnecessary to graze the woods. Pastures save barn feeding in the summer time. And good pastures prevent overgrazing of new seedings by furnishing plenty of forage, thus making it unnecessary to graze new seedings.

As pointed out in Chapter I, some land is better suited to grass than to any other use. To make this grassland more productive will improve the entire farm program. (Figs. 18-1 and 18-2.)

Permanent Pastures

Renovation of permanent pastures requires several specific operations. Illinois Circular 703 lists five steps:

1. Testing and treating the soil
2. Tearing up the old sod



(Photo: U. S. Soil Conservation Service)

Fig. 18-1. An improved pasture on rolling land in Wisconsin.



(Photo: U. S. Soil Conservation Service)

Fig. 18-2. Improved pasture on a 10 per cent slope in Louisiana.

3. Seeding the right kind of legumes and grasses
4. Controlling the grazing
5. Controlling weeds by clipping

2. Testing and Treating the Soil

For really good results, a pasture must produce a mixture of legumes and grasses—at least one deep-rooted legume is desirable. Legumes are palatable and nutritious, and if inoculated, they supply a large amount of nitrogen to the companion grasses which makes them more productive, palatable, and nutritious. But to grow these legumes the soil must be sweet and well supplied with minerals. Most poor pastures are poor because the soil on which they are growing is low in one or more of the essential plantfoods. A soil test

will show which minerals a soil needs and how much of each is needed to correct the deficiency.

So the first step is to test the soil for acidity, phosphorus and potassium. If the soil needs lime, put it on if possible at least six months ahead of the time of seeding legumes. Apply phosphate and potash when the seedbed is being prepared.

Tear Up the Old Sod Thoroughly

The minerals applied as a result of the soil test will not be fully effective until they are mixed with the surface soil. Spreading them on top of the old pasture is not enough. The pasture should be torn up. In most localities, thorough killing of the old grass is needed. Tearing up the pasture does three things:

It destroys or weakens the old sod and keeps it from competing too quickly with the new seeding.

It mixes the needed fertilizers with the topsoil.

It helps prepare the seedbed for the new legumes and grasses.

The job must be done thoroughly. Shallow breaking is usually best and can be done with a variety of farm tillage tools. (Fig 18-3.) How best to do the job depends on the amount of vegetation on the surface and the nature and contour of the land. On level to moderately sloping land, where erosion is not a serious problem, plowing makes a good seedbed. This is especially true if the sod is heavy or there is considerable growth of weeds or grass on the surface. If the sod is thin and there is little top growth, the disk or field cultivator will do a satisfactory job. Whether the plow or disk is used, it is important to work sloping land on the contour.

On steep hillsides where erosion is a problem, plowing is not recommended. Use a disk, field cultivator, or similar tool. (Figs. 18-4 and 18-5.) Work the ground shallow at first, making each operation progressively



(Photo: J. I. Case Company)

Fig. 18-3. Breaking old sod with a moldboard plow, operating on the contour.

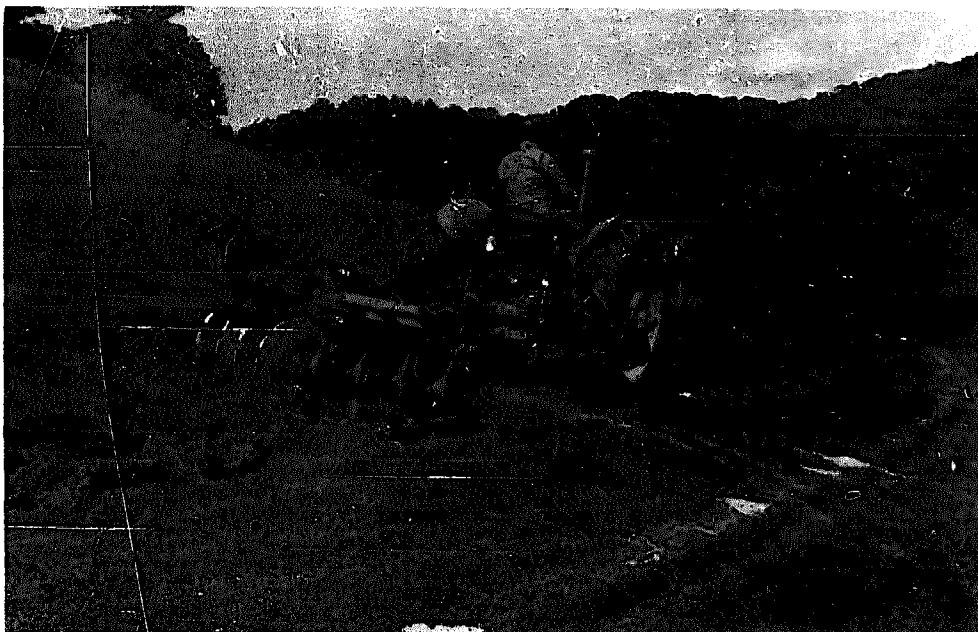

(Photo: J. I. Case Company)

Fig. 18-4. The pasture renovation disk works well on rough land not tillable with other implements.



(Photo: U. S. Soil Conservation Service)

Fig. 18-5. Pasture renovation with the spring tooth harrow.

deeper. A criss-cross procedure with the spring tooth harrow divides the sod into thin squares. First work up and down the slope at shallow depth, then across the slope on the contour at the deeper depths. The final operations should be on the contour to help prevent erosion.

If a disk or tool other than a plow is used, spread the limestone and other fertilizer materials on the surface and let the cultivations work them into the soil. If you plow, spread the materials on top of the plowed ground and work them into the soil with a disk or harrow as the seedbed is prepared.

For most areas it is suggested that the seedbed preparation be started in late summer or early fall when the vitality of the grass is low. It may be necessary to make additional trips over the field with a disk or cultivator to keep the sod loose and to prevent growth of grass and weeds, and leave the ground open

to receive rain and snowfall. A spring tooth tiller can be used to work the ground up to freezing time in the North or until seeding time in any location.

A firm, carefully prepared seedbed pays off by insuring a better stand, mellow but firm, smooth with no large clods, and preferably rolled to firm the soil just ahead of seeding. (Fig. 18-6.)

Seed Desirable Legumes and Grasses

After applying the needed soil treatment and pre-



(Photo: J. I. Case Company)

Fig. 18-6. The cultipacker is a useful tool to firm the seedbed. It is sometimes used following seeding to press the seed into the soil.

paring a good seedbed, the next step is to seed legumes and grasses that do well in your area. Try to establish a mixture of both types of plants. Legumes fix nitrogen and supply high-quality forage; the deep-rooted ones are drought resistant. The grasses aid in erosion control and help protect the legumes against heaving and other winter injury. A good percentage—about half—of grass in the mixture helps prevent bloat.

The kind and amount of legume and grass seed to use in the pasture mixture will depend on the locality, the type of soil, the climate, the moisture conditions, and many other factors.

Because of the many different seeding mixtures that are necessary to fit the various soil and climatic conditions throughout the country, no attempt will be made to list them here. Check with your vocational agriculture teacher, your county agent, your local soil conservationist and the recommendations of your college of agriculture for the pasture seeding mixture you should use.

Make Firm Seedbed

Illinois Circular 703 suggests scattering the legume and grass seed on a firm rolled surface and then pressing the seed into the surface with a corrugated roller (Fig. 18-6). Very little soil is needed to cover legume and grass seeds. Disking these seeds into the soil, as is done with oats, buries and kills many of the small seeds of legumes and grasses.

Use a Companion Crop

Ohio Bulletin 261 points out the advantages of using companion crops. First, they permit a return from the land in the seeding year; second, a more harmful companion crop of weeds may take their place; third, on

sloping land, they produce an erosion-resisting growth more rapidly than small-seeded forages; and fourth, winter cereals may reduce freezing injury to seedlings or early-sown legumes.

In Ohio, oats are preferable to wheat as a crop in which to sow alfalfa, while wheat is often definitely superior to oats as a crop in which to sow red and ladino clovers. Early varieties of oats are preferable to late varieties as a companion crop for any forage. Spring barley is even more favorable than oats as a companion crop for alfalfa. Winter barley and rye make so heavy an early growth that they are less favorable than wheat, even for red clover.

Most drills have a special hopper for the legume seed which is drilled through tubes to the surface of the ground. A large hopper holds the grass seed or the grass seed mixed with grain seed for a companion crop. Another hopper holds the concentrated starter fertilizer placed well below the surface of the soil by the furrow openers.

Another method is to pull a grain drill for drilling the companion crop and the starter fertilizer into the ground with disk furrow openers. Legume seed from a small hopper is carried through tubes and deposited on the surface behind the openers. A lime sower is trailed behind the drill to broadcast bromegrass seed. (Fig. 18-7.)

Ohio has been using another method known as band seeding which consists of placing the seed directly above, but not in contact with, drill rows of fertilizer. This method requires special attachments to the grain drill consisting of lengths of garden hose to carry the legume and grass seed behind and above the fertilizer. Band seedings require less seed, result in more vigorous plant growth and less weeds than seedings made by broadcast methods, according to Ohio Bulletin 261.

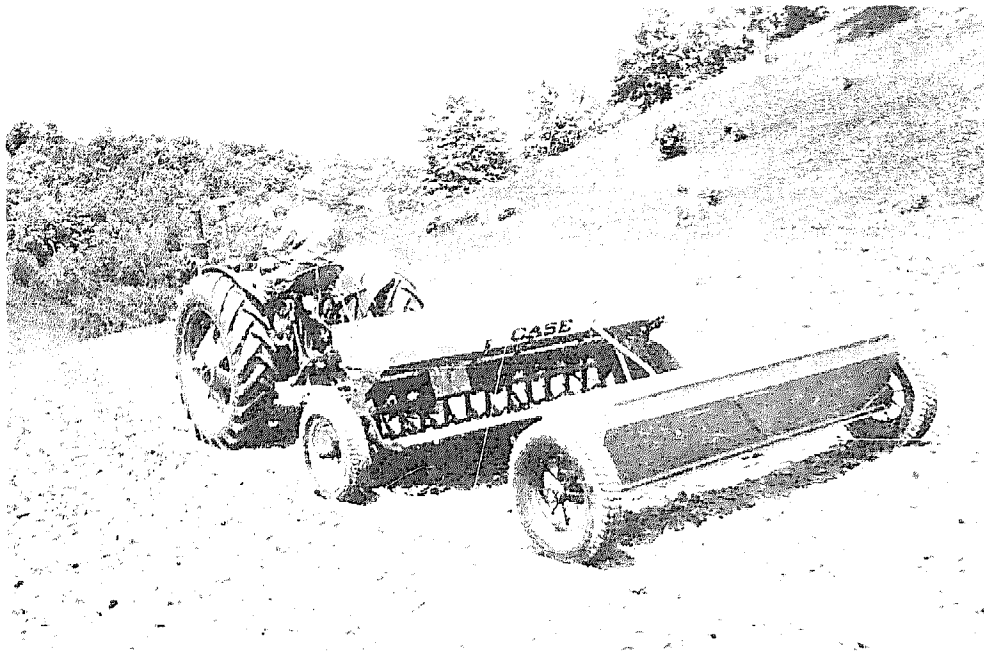

(Photo: J. I. Case Company)

Fig. 18-7. This man is using a grain drill in front to drill the companion crop and starter fertilizer into the ground with disk furrow openers. Legume seed from a small hopper is carried through tubes and deposited on the surface behind the openers. The lime sower trailed at the rear is used to broadcast bromegrass seed.

Control Grazing

It is important to use good judgment in grazing pastures because overgrazing can easily result in losses that will cancel gains from soil treatment, renovation and reseeding. The first year is especially important.

3. Pasturing the New Seeding

Nurse crops can be pastured off during the early part of the season. But do not graze the pasture seeding too close. After the animals have grazed off the nurse crop, take them off and let the seeding recover before allowing further light grazing during the rest of the year. If no nurse crop is used, the time for turning in the stock will depend on the amount of growth. Grazing then should be moderate. Legumes should not be

grazed late in the fall because during the fall they build up food reserves in the roots that will be used for growth the following year. Summer or fall seedings should not be grazed the year they are seeded.

Rotation Grazing — Graze Quickly

According to the Yearbook of Agriculture GRASS, farm animals never eat pasture herbage down to a uniform height unless compelled by being confined to an area so small that it is pastured out completely within a few days. Without this restriction, the animals graze in spots and the grass first refused is eaten only after livestock have failed to obtain a fill from vegetation shortened by previous grazing. This results in both overgrazing and undergrazing.

By fencing the pasture into two or more separate enclosures of equal size to be grazed alternately, the forage can be grazed down quickly to the desired level as soon as it has grown to a height suitable for grazing. Between these brief periods of intensive grazing, it is protected from defoliation and trampling.

Each grazing period lasts from 1 to 2 weeks for an individual herd or flock; and the intervening rest periods will last from 2 to 4 weeks, depending on the number of enclosures, the kind of pasture, and the weather.

Even when rotation grazing is practiced, tall grass will accumulate near droppings. If each field is mowed a day or two before the animals are to be removed, most of this previously avoided grass will be eaten after having been moved by the mower a short distance from the excrement around which it grew.

Rotation grazing has been advocated in some states while in others the increase in production has not appeared to justify the extra cost of fencing and providing water.



(Photo: U. S. Soil Conservation Service)

Fig. 18-8. Sudan grass makes an excellent supplementary pasture to use when permanent pastures need a rest and to take up the slack when forage is needed.

Avoid Overgrazing

Overgrazing can be avoided by using permanent pasture in combination with an ample acreage of rotation pasture of alfalfa or other meadow crops. Small grains, such as rye, barley or winter wheat and Sudan grass may be used as supplementary pasture if needed (Fig. 18-8). Other supplementary pasture crops may be used, depending on the locality (Fig. 18-9).

A pasture calendar (Fig. 18-10) is very useful in

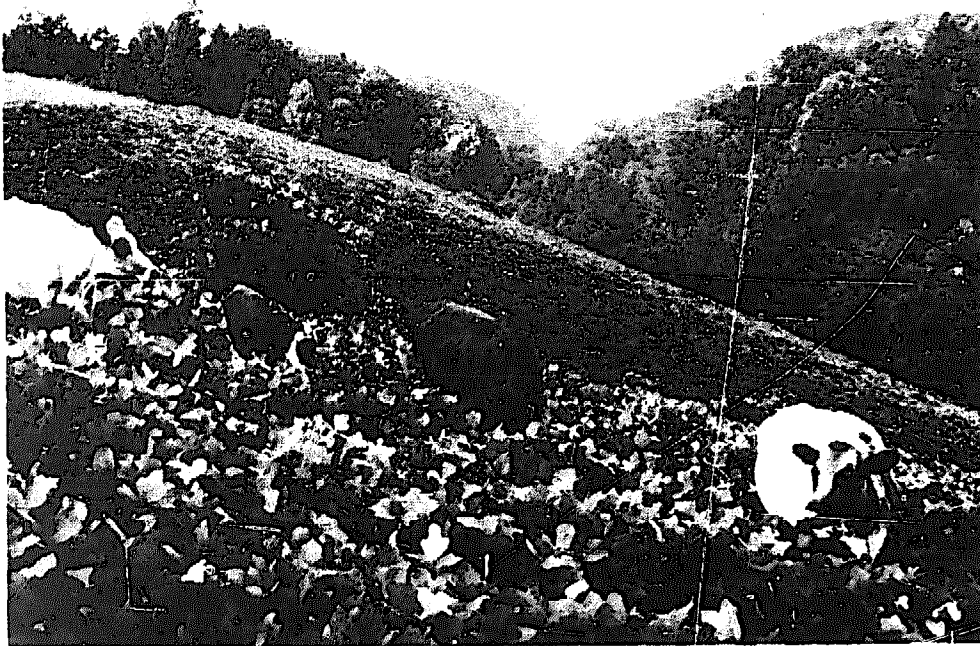

(Photo: U. S. Soil Conservation Service)

Fig. 18-9. Kudzu furnishes supplementary pasture in the southern states.

POSSIBILITIES FOR SEASONAL PASTURE PLANNING

AGRONOMY DEPARTMENT, UNIVERSITY OF WISCONSIN & SOIL CONSERVATION SERVICE

PASTURE	MAY	JUNE	JULY	AUG.	SEPT.	OCT.	EXPECTED CARRYING CAPACITY PER ACRE BY COW PASTURE DAYS
RYE	■						30
BLUE GRASS		■	■			■	90
BLUE GRASS RENOVATED		■	■	■		■	140
BLUE GRASS NITROGEN FERTILIZED		■	■	■		■	130
ALFALFA OLD GRASSY		■	■	■		■	120
SWEET CLOVER WITH TIM O RED CL (2ND YR)	■	■	■	■		■	135
SUDAN GRASS			■	■	■		90
NURSE CROP		■					30
ALFALFA & BROME OLD STANDS		■	■	■		■	150
ALFALFA & BROME YOUNG STANDS SECOND CROP				■		■	50
CANARY GRASS		■	■	■	■		125
MEADOW AFTERMATH				■			40

(From Wisconsin College of Agriculture)

Fig. 18-10. A typical pasture calendar for Wisconsin. Look up the pasture calendar for your locality.

planning for grazing, balanced all during the season. One for your state should be available to you for study.

4. Controlling Weeds by Clipping

Most old pastures have a lot of weed seeds in the soil ready to take full advantage of the improvement practices (Fig. 18-11). Weeds can endanger the new seedlings by robbing them of needed sunlight and moisture as well as plant food. The good growth of legumes and grasses resulting from the soil treatment helps to keep down the weeds, but some additional control is usually needed.

Clip Twice a Year

Clipping the weeds at least twice a year usually pays

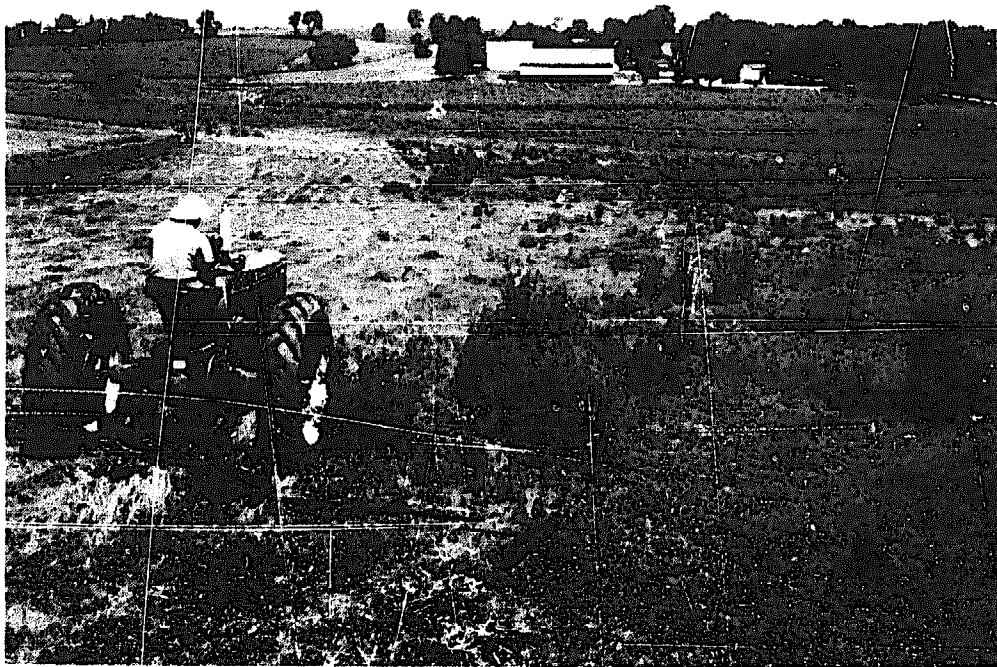

(Photo: U. S. Soil Conservation Service)

Fig. 18-11. Illinois farmer mowing bull thistles in a 40-acre pasture on 15 per cent slope.

good dividends. Clipping in late May or early June for the early weeds and again in August for the later ones will usually do the job. Be sure to clip before the weeds go to seed. Weeds, especially the perennials, are injured most by clipping when they start to bloom. Weeds should be cut 3 to 4 inches above the ground, just low enough to set back the weeds with a minimum of damage to the new seedings.

5. Planning Range Conservation

Successful ranchers have learned from experience that they must follow four principles in order to keep the range productive and to protect the soil:

1. Adjust promptly the numbers of livestock to the available forage supply.
2. Adjust by seasons the grazing use of each unit or pasture to meet the growth requirements of the main forage plants.
3. Locate fences, stock-water facilities, and salt to insure even grazing of each pasture or unit.
4. Keep the kind of stock that will graze most economically the kind of forage found on the ranch.

The ranchers give several reasons why this is true:

1. The profits of planned conservation show up in increased and sustained forage yields, better calf and lamb crops, higher weights of market animals, and enhanced security against drought and other seasonal variations.
2. Grasses and other forage plants, effective protectors of the soil, are easily damaged by too close grazing, spotted grazing, and grazing too early in the spring. Even under normal or favorable conditions, grazing plans should be flexible enough to allow adjustments in time.
3. Grassland on the ranch must be used in relation

he has a basis for determining what he needs to do to restore poor grassland conditions and the degree and rate of improvement he can expect.

The condition of natural grasslands is determined by the relative amounts of the climax vegetation for that site that it is still supporting. (Climax vegetation is the highest type of vegetation that a given site will support under natural conditions. It means, actually, the vegetation that grew there before man began using the range for cattle and sheep. This climax vegetation will vary with climate and soil conditions.) Ranges are considered to be in "excellent" condition when three-fourths or more of the vegetation is made up of these climax plants. Land supporting less than this percentage is placed in lower classes. Where plants that are climax for the site make up from one-half to three-fourths of the cover, the range is considered in "good" condition; from one-fourth to one-half, "fair" condition; and less than one-fourth, "poor" condition. Forage yields follow much this same relationship but may vary considerably depending on soil, topographic, climatic, or other characteristics of each site. However, some grassland sites in "poor" condition can be improved to the point where they will produce eight or ten times their present yields of forage.

The inventory also gives information on how much forage is available for use in terms of the number of livestock and the season when it may be grazed for greatest returns without injury to the best forage plants. Other information affecting forage production and the use of the range is recorded: Periods of plant growth, which has a lot to do with the time when plants can be grazed without injury; the possibilities for subdividing the grazing area into units that are easier to manage; and the possibilities for improved deferred-rotational grazing. The location of water supplies and

whether there is enough water, the possibilities of developing additional water supplies, and the areas that need reseeding are especially important facts to record in making the inventory.

Map Area

The map can show the boundaries of each condition, class, or site. It can show the location of land suitable for cultivation and land that should be kept in grass or trees. This separation of land use is based on the kind of soil, slope, erosion, fertility and other factors. (See Chapter I). The cropping history of each field is useful as a guide in future planning.

It is important to know whether enough forage and feed can safely be grown on the ranch to feed the planned numbers of livestock. When such supplies are inadequate, the plan outlines the steps necessary to develop additional forage and feed resources, or to change the grazing use by adjusting livestock numbers in order to balance the forage supply and livestock feed requirements.

The amount of green forage and other feeds needed annually and seasonally is influenced by the type of livestock operation and the number of animals that must be raised to furnish a satisfactory income. The type of livestock, in turn, bears on the time the animals are kept before marketing. For example, the sale of cattle as yearlings rather than two-year-olds markedly reduces the annual feed needs.

Determine Number Animal Units

To determine how much forage and feed will be needed, make a simple list of the number of each kind and class of livestock kept on the ranch and the feeds customarily grown or purchased. Then estimate the

grazing capacity of each pasture in terms of animal-units that can be supported safely each season.

Similarly, analyze the current field-by-field production of cultivated forage crops and supplemental pastures and the season in which such crops and pasture become available.

Calculate both the available and required feeds in terms of animal-unit-months (that is, the amount required to feed one cow or 5 ewes one month). Use commonly recognized feed equivalents to convert tons of hay, bushels of grain, et cetera, to animal-unit-months of feeding value.

Though the number of livestock is governed chiefly by the total forage and feed resources available, the stocking of any individual pasture may depend entirely on how much forage is available during a particular season. Climate, elevation, condition of the range, kind of forage, and availability of water are some of the factors to be considered. Growth requirements of the plants themselves are important: Some forage plants require more sustained top growth for full production than do other plants; some will stand close grazing near the end of the growing season without injury. For example, other things being equal, stoloniferous grasses can be grazed more closely in the fall than the bunch grasses.

Compare Yields with Animal Units

When the seasons of use of grazing units and the seasonal availability of feeds from croplands have been settled, make a tentative distribution of the grazing and feeding yields for all lands of the ranch. Make a sketch map of the ranch to show the approximate location, size, and yield in animal-unit-months of the various fields and pastures. Compare the estimated seasonal yields of the grazing lands and cropland with

the seasonal feed requirements of the livestock. Such a comparison provides information that will help determine adjustments of land use, livestock numbers, and grazing practices needed to obtain full use of grazing land and cropland without overuse, and to avoid the hazardous seasonal depletion of feed and forage supplies.

Decide upon the conservation practices and remedial measures that will be used to restore and maintain the plant cover and outline them in the plan, unit by unit. Give particular attention to overgrazed and eroded areas and to areas where plant vigor is low. Plan to reseed depleted grassland areas and abandoned croplands with adapted grasses to overcome seasonal forage shortages. You may have to plant additional hay, silage, or grain crops, and supplemental pastures for a balanced year-long livestock operation.

The plan should outline a suitable system of grazing designed to improve the yield of depleted lands and to obtain sustained optimum production for each site now in good or excellent condition. It should show where fences will be built to make deferred rotational and seasonal grazing possible. Improperly placed fences hindering proper distribution of livestock on the grazing area should be marked for removal. The plan should specify the water developments required to avoid destructive daily trailing and traveling of stock to and from water. It should indicate the amount, location, and period of supply of salt necessary to encourage stock to graze under-utilized areas, and to avoid stock concentrations around salt and water, where they are located close together, so destructive to grazing lands. It should outline the action to be taken to control noxious and poisonous plants, install contour furrows and water-spreading systems, and protect the grasslands from fires, injurious rodents, and insect enemies.

Make Seasonal Adjustments

Because the growth of grass is seasonal and fluctuates from one season to the next, it is important that the conservation plan contain provision for evaluating the measures specified in it and suggest possible adjustments. You will need to observe seasonally and annually how grazing is affecting the volume of available forage and how grazing is affecting the reserves of ungrazed forage you will need for the remainder of the planned grazing period; also, what effect current grazing is having on the productivity of the grasslands.

Planning is progressive. Measures and practices may be established as the resources of the operator permit, but their establishment should always be in keeping with the comprehensive plan for the ranch as a whole, and should contribute to the conservation objective for the ranch as a unit. Generally, the more rapidly a comprehensive plan can be instituted, the quicker will the grassland respond to improved methods of management and supplemental treatment, and the earlier will economic benefits be forthcoming.

Chapter

XIX

LAYING OUT AND CONSTRUCTING FARM DRAINAGE

According to Farmers' Bulletin 2046, U.S.D.A., draining fertile, wet cropland is one of the important practices of conservation farming. Draining wet land is one way of giving land the treatment it needs to grow the kind of crops it is best fitted to grow. This is good farm management.

A Suggested List of Activities Involving Approved Practices

1. Draining Wet Land
2. Deciding How to Drain
3. Planning the Drainage System
4. Planning the Outlet
5. Planning Surface Drainage
6. Constructing Outlets and Outlet Ditches
7. Constructing Field Ditches
8. Staking Out Ditches
9. Maintaining Open Drains
10. Mowing and Pasturing Ditches
11. Smoothing Land
12. Using Underground Drainage

13. Determining Size of Tile
14. Spacing Tile
15. Selecting Tile
16. Staking Out Tile Drains
17. Trenching with Machinery
18. Trenching by Hand
19. Establishing Grade
20. Digging Trenches
21. Laying Tile
22. Blinding Tile
23. Backfilling Trenches
24. Using Location Map

1. Draining Wet Land

On many farms, the bottom lands have the most fertile soil. But because they are wet part of the year, they produce only part of the yield they could produce. Once drained they will produce bumper crops. And by draining this flat land the steeper land on the farm can be protected against erosion by being kept in grass, meadow, or trees.

How Drainage Helps

A wet soil is a cold soil. This is because it takes much more heat to warm water than to warm soil. When soil is drained, air replaces the water that is drained away (Fig. 19-1). It takes relatively little heat to warm this air. Plants grow better in warm soil and where there is air in the root zone. Beneficial bacteria work better in such conditions.

A wet soil is likely to be tight—or compact or dense. Plant roots cannot spread easily through such soil. Legumes do not grow and it is not easy to build up the soil or to follow a good rotation.

After a wet soil is drained it can be worked earlier in

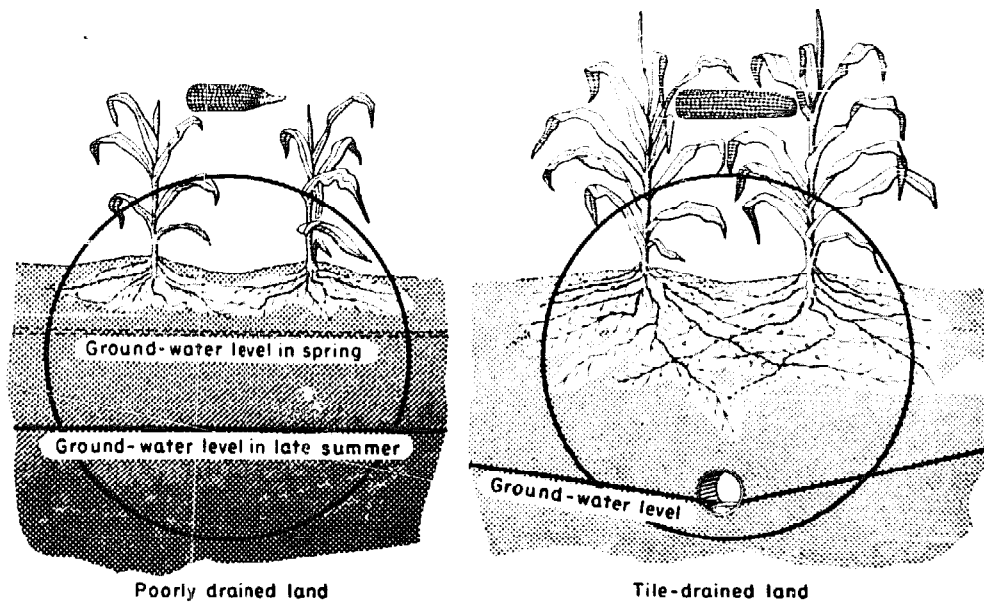

(Drawing: U.S.D.A. Farmers' Bulletin 2046)

Fig. 19-1. Why land needs drainage. Plant roots cannot spread in a soil that is wet nearly to the surface. If the water table falls because of summer drought, the crop "burns out."

the spring. Seeds germinate faster and a better stand results. Cultivation can start sooner after rains. Crops can be harvested easier.

A properly drained field will not have wet spots, so you can farm more efficiently. The whole field can be farmed at a time. Yields will be bigger and will be uniform over the whole field. And less labor will be needed because it will not be necessary to farm around the wet spots.

Crops planted on land that needs drainage often "burn out." In a soil that is saturated nearly to the surface in spring and early summer, the plant roots spread out near the surface. Later, when summer droughts come, the water table falls below this root zone and the crop gets little moisture. In well-drained land, the roots go down deeper. Thus they can draw on deeper moisture, and the plants are better able to withstand summer droughts.

2. Deciding How to Drain

Excess water can be drained from land either by open ditches or by underdrains, usually tile. Each has its place and there are advantages and disadvantages to both.

Open ditches occupy land. They may be hard to cross with farm machinery. They choke up with weeds and silt and have to be cleaned. Unless they are deep, they drain only the surface, not the soil. But their first cost is less than tile drainage. And for tight soils in humid areas, surface drainage is usually necessary. Open ditches are also used for outlets for both open and tile drains.

Tile drains, on the other hand, waste no land and do not interfere with farm operations. They need little care once they are installed. Since they drain the pores of the soil, roots of crops can spread. But usually tile drains require more cash outlay in the beginning. And they are not effective in some soils.

3. Planning the Drainage System

The conditions in each area determine the kind of drainage needed. What is good in one place may not be good in another. The kind of soil, the ground slope, the crops to be grown, and the value of the land must all be considered. Neighboring farms must also be considered. A good drainage system often involves a number of farms.

Use Detailed Map

The first thing needed is a detailed map of the land. This map must show the kind of soil—how productive it will be if drained, how tight it is, how deep to an unfavorable layer such as sand, gravel, rock, or high

water table. This kind of information will help determine if the land should be drained at all.

The next thing needed is to decide on an outlet; that is, how the water will be carried away and where it will be discharged.

Plans for successful farm drainage must include plans for controlling erosion on the land, on ditches and spoil banks, and at outlets. They must include plans for farming the drained land in crop rotations that will bring about good soil structure. And they must also include plans for keeping the drains working.

Some simple drains can be located by inspection. But most drainage jobs require the use of engineering instruments and careful techniques. Getting water to move properly off land that is nearly level cannot be done by guessing.

A map is needed that shows the following:

Boundaries and slopes of the areas needing drainage.

Existing drains.

Location and elevation of all swales and water-courses, knolls and ridges.

Location and elevation of possible outlets.

Area that will drain into each part of the system.

The drainage system can be laid out readily on this map; grade and sizes of drains can be determined; and costs estimated.

Stake Location

After the drains have been laid out on the map, they can be staked in the field. Any minor changes needed can be made then. The next step is to run levels along the lines of each proposed drain. This is necessary to determine accurately the grade or fall available for each. Then establish the grade to which the ditches or trenches must be dug. The most practical way to do this is to plot a profile of each drain and then deter-

mine the most economical adjustment that will give good drainage.

Determine Kind of Soil

It is also a good idea to make borings to find out what kind of material you must dig through.

It is apparent that this kind of work requires the help of an engineer. But it is necessary that students of agriculture understand what is needed so that good drainage will be provided for.

4. Planning the Outlet

The outlet is the key to the whole drainage system. Without a good outlet other good features of the system will be of little value.

Make Large Outlets

The outlet must be large enough. It must carry away the water brought to it promptly enough to drain the field intended for drainage and without damaging other land. The size of the outlet depends on a combination of many factors—the rainfall, the area of the watershed, the slope, the soil, the vegetation. See local drainage engineers for help in planning the size of your outlet.

The outlet must be deep enough to let water flow into it from tributary drains. Where the land is to be tile drained, the outlet should be at least 5 feet, preferably 6, below ground surface. The water, except for short periods after storms, should be at least 4 feet below ground surface.

An outlet into which tile drains empty should carry the water reaching it without submerging the tile for long after a heavy rain. The ideal outlet permits free flow from the tile at all times.

The ownership of the land where the outlet is located is an important consideration. It is not always possible to find an outlet on your own land.

5. Planning Surface Drainage

It should be kept in mind with any type of drainage that the main object is to remove the water as fast as possible. With surface drainage this is done through open ditches. These ditches empty into larger and larger ditches until they reach some natural or artificial watercourse that carries the water away without damage to the land. Different methods of laying out field ditches are discussed briefly here.

Random Ditch System

Where the land is somewhat rolling or uneven, it may be possible to get surface drainage by shallow field ditches that follow the depressions. This is sometimes known as the random ditch method, meaning that the ditches are placed at random and no particular pattern is followed. (Fig. 19-2.) The location for the ditches can be found by observing where water stands after heavy rains. Some smoothing of these fields may be necessary to improve the drainage. See activity number 11, "Smoothing Land." By smoothing, the minor depressions can be removed and the land drained to the large depressions and to the random ditches. After the low places in a field are drained with the random ditch method, they can be gradually brought into cultivation. In a few years the value of the entire field will be increased.

It should be kept in mind, however, that shallow ditches remove only surface water. If the land needs soil drainage, ditches must be more numerous and deeper, or tile must be laid.

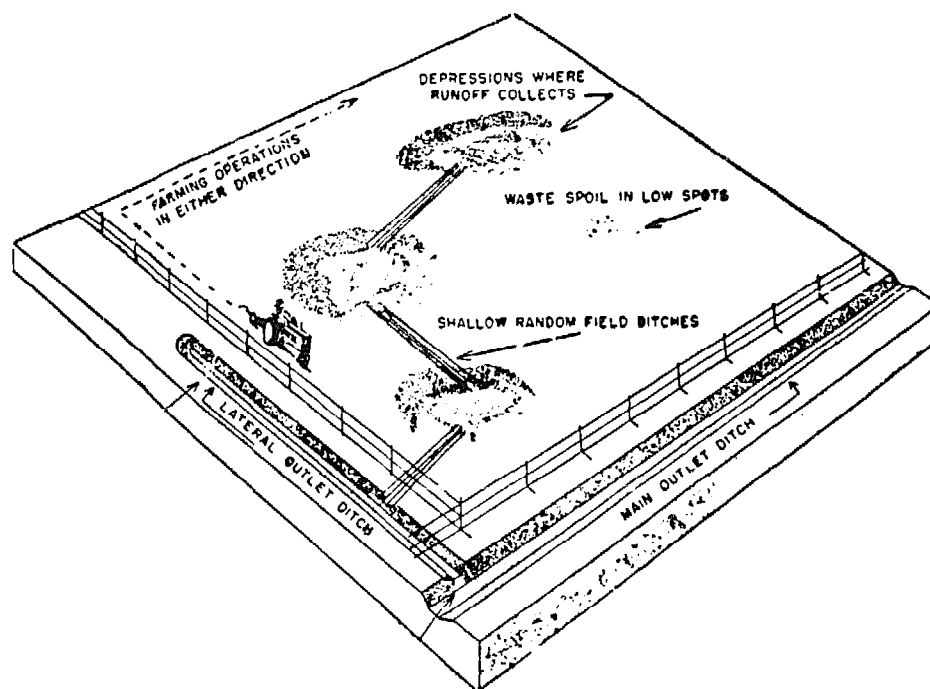

(Drawing: U. S. Soil Conservation Service)

Fig. 19-2. Random ditch system of surface drainage. The lateral outlet ditch should be a half foot to a foot deeper than the random field ditches.

Such a system means that the ditches may be crooked, which is a disadvantage in farming. It may be necessary to cut through a low ridge or knoll to avoid a sharp bend. Changes in direction should be made by easy curves in order to prevent erosion of the ditch banks. You can lay these curves out by "eye."

Cross Slope Ditch System

This method of surface drainage is adapted to sloping, wet fields of 4 per cent slope or less, where internal drainage is poor from the plow sole downward and where many shallow depressions hold water after rains (Fig. 19-3).

The cross-slope ditches should be constructed across the slope as straight and as nearly parallel as the topography permits. The spacing should be about 100

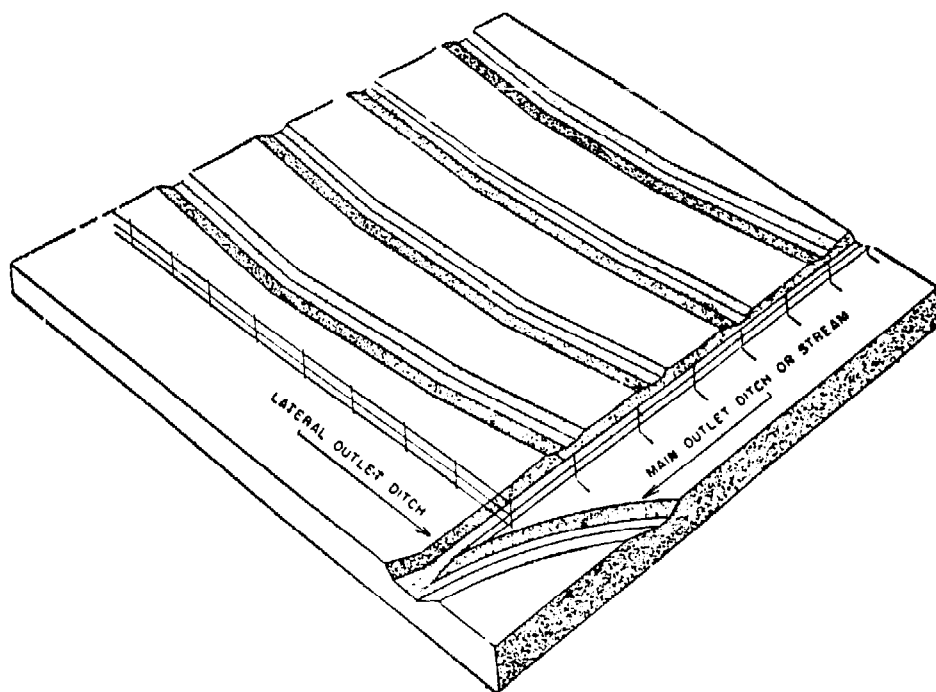

(Drawing: U. S. Soil Conservation Service)

Fig. 19-3. Cross slope ditch system of surface drainage. Cross slope ditches should be constructed across the slope as straight and as parallel as the topography will permit.

feet on a 4 per cent slope, increasing to 150 feet as the slope decreases to 0.5 per cent.

These ditches differ from regular terraces in that little or no ridge is permitted on the down-slope side of the ditch. This makes it easy to cross them and reduces damage caused from overflow. The excavated material should be placed in the depressional areas between the ditches. Any material not so used should be spread out on the downhill side of the ditch so that the ridge is not over 3 inches above the natural ground surface.

The key to the success of this system is the elimination of the depressions between the ditches so that no runoff will be permitted to collect and stand on the surface. With ditches spaced at regular intervals down the slope, runoff can be collected and carried from the field. Farming operations should be parallel to the

ditches. Side slopes should be very gentle to make farming over them easy.

Parallel Ditch System

The parallel ditch system, as illustrated in Fig. 19-4, is adapted to flat, poorly drained soils in which there are numerous small shallow depressions. Sometimes bedding (Fig. 19-6) has been used for this type of problem. However, if the land is smoothed or graded to eliminate the minor depressions, uninterrupted crop row drainage to the parallel ditches is possible. It may cost more to install this system than the bedding system but it permits easier farming operations, particularly with large machinery.

Crops can be planted from one end of the field to the other over the ditches, thus permitting maximum length of rows.

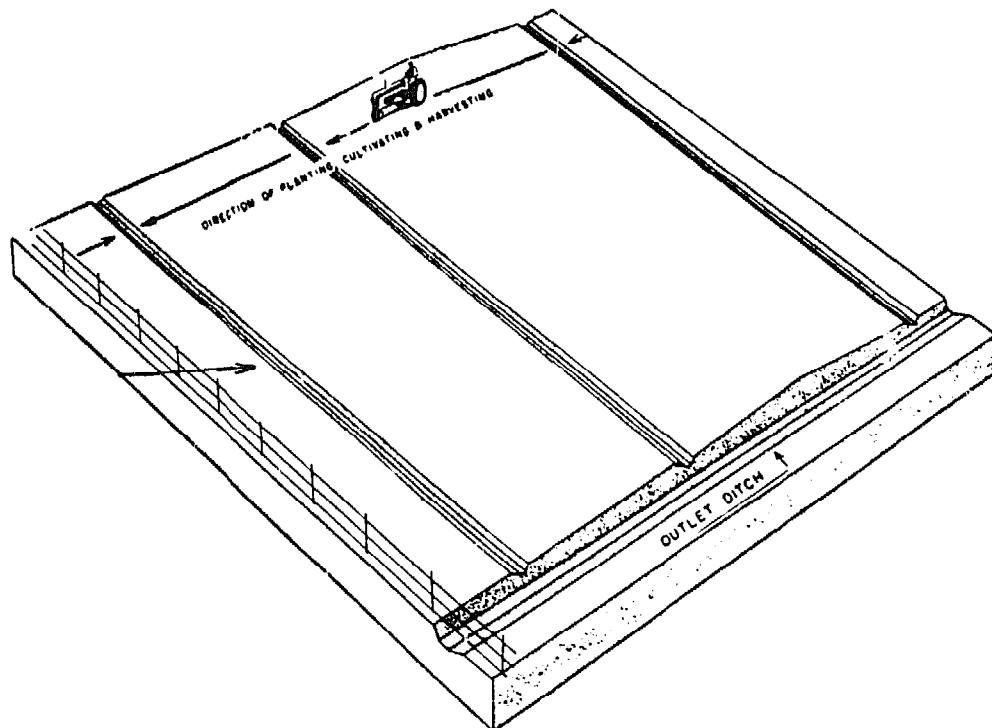

(Drawing: U. S. Soil Conservation Service)

Fig. 19-4. Parallel ditch system of surface drainage.

The field ditches should be parallel but not necessarily equal distances apart. The success of this system depends on smoothing the land so that each row drains to a ditch through its entire length. The ditches will have to be spaced so that this can be done and so that each row can carry the runoff without much overflow or erosion damage in the row.

Field experience has shown that the maximum length of grade draining to a given ditch should be about 600 feet. This maximum length should be reduced on slowly permeable, highly erosive soils to about 300 feet.

Field Ditch System

This system is used where it is necessary to lower the water table. It is used where the high water table is the limiting factor in crop production but where tile cannot be used.

The field ditches are laid out in a regular parallel pattern across the field, but are deeper than the ditches used in the other systems. These deeper ditches provide for lowering high water tables enough for crop production as well as for removal of surface water (Fig. 19-5).

Because the ditches are made so deep in this system of drainage, it is usually not advisable to try to make them crossable with farm machinery. Shallow ditches should be made between the deep ditches to intercept crop rows, dead furrows and plow furrows, and to direct the flow into the deep ditches through protected overfalls.

Farming operations should be parallel to the deep ditches.

Bedding

Bedding is another system of farming wet land. It

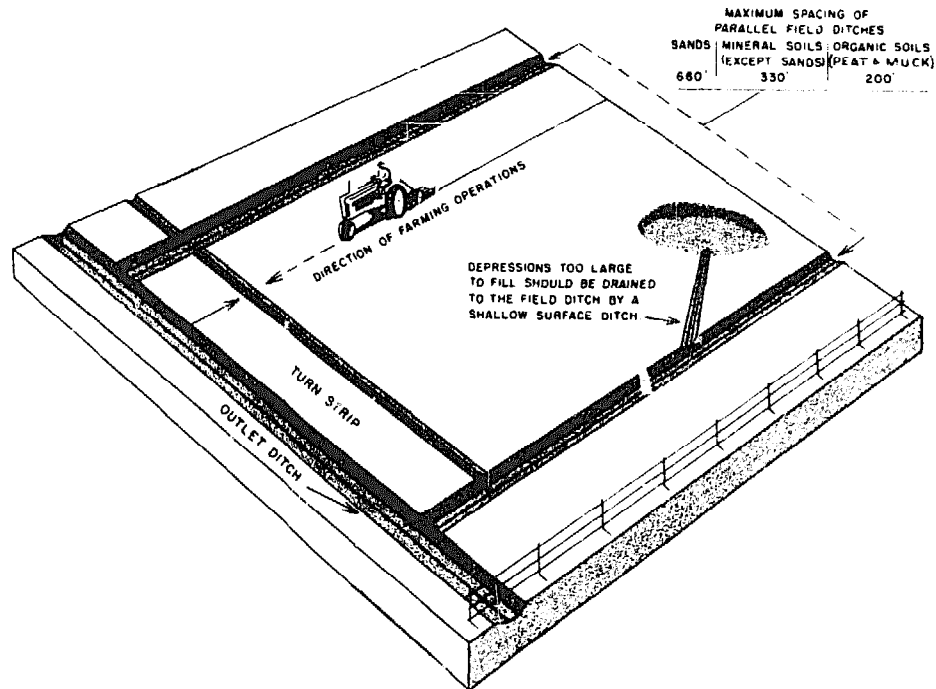

(Drawing: U. S. Soil Conservation Service)

Fig. 19-5. Field ditch system for water table control and surface water removal. Field ditches are made deep enough to lower the water table. Shallow ditches intercept furrows and crop rows to carry the runoff to the field ditches.

consists of alternate dead furrows and back furrows spaced according to the kind of soil. The beds are intercepted at the ends of the field by collection ditches.

The beds are constructed and maintained by plowing (Fig. 19-6). Simply plow a backfurrow down the middle, leaving a dead furrow to serve as a shallow ditch. If one plowing does not give the desired height, replot

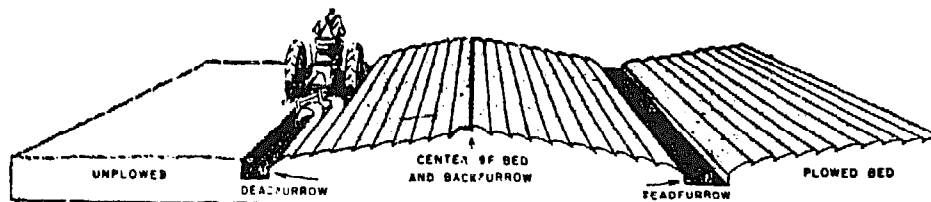

(Drawing: U. S. Soil Conservation Service)

Fig. 19-6. Cross section of beds showing construction method with plow.

as before. The width of beds depends on the kind of soil and the crops to be grown. (See Table 19-1.)

After plowing, farming operations can be in either direction.

Usually a turn strip is left between the collection ditch and the edge of the field. This strip can be plowed as another bed.

TABLE 19-1. Width of beds for different kinds of soil, crops, and number of rounds to plow with two 14-inch plows.

DEGREE OF INTERNAL DRAINAGE OF THE SOIL	WIDTH OF BED IN FEET CENTER TO CENTER OF DEAD FURROWS	NO. OF 3½' CORN ROWS WITH 2' ALLOWED PER DEAD FURROW	NO OF ROUNDS USING 2 - 14" PLOWS
VERY SLOW	23	6	5
	30	8	6½
	37	10	8
SLOW	44	12	9½
	51	14	11
FAIR	58	16	12½
	65	18	14
	72	20	15½
	79	22	17
	86	24	18½
	93	26	20

6. Constructing Outlets and Outlet Ditches

Outlet ditches must be deep enough to drain all land draining to them—5 feet or deeper for tile and 4 feet or deeper for surface drainage. These deep ditches are usually constructed with a drag line.

Side Slopes

Large ditches, constructed with side slopes not steeper than 4 to 1, can be crossed with machinery although they may not be farmed (Fig. 19-7). But the banks can be planted to grass and mowed for hay. Side

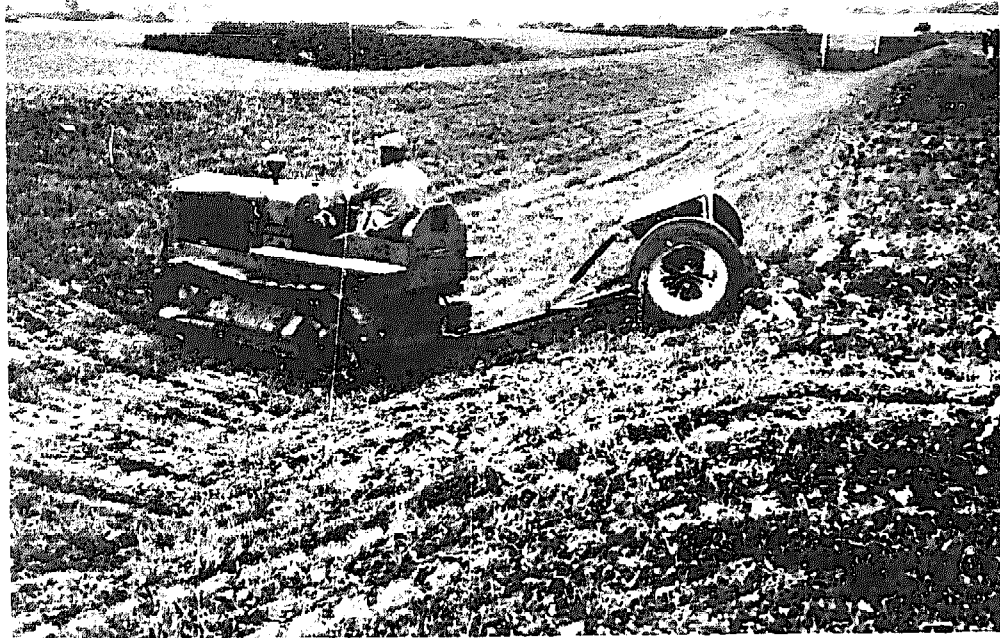

(Photo: U. S. Soil Conservation Service)

Fig. 19-7. Tractor applying fertilizer to ditch in Illinois. Side slopes are gentle enough to permit working over with machinery.

slopes may be as steep as $1\frac{1}{2}$ to 1 where weeds are controlled with chemicals.

Berms

The berm is the strip of ground between the edge of the ditch and the nearer edge of the waste or spoil bank. One of its purposes is to avoid adding the weight of excavated earth at the edge of the ditch. Too much weight would be likely to cause caving of the bank. Another is to give room for man and machinery to work when clearing the channel of sediment, debris, or growing plants.

Berms should be at least 10 feet wide where spoil

banks are not leveled. On large outlet ditches they should be wider, usually 15 to 20 feet.

Spoil Banks

Place the "spoil" excavated in making the ditch back of the berm stakes. The banks should not be so steep that rains will wash the material back on the berm. And there should be openings through the spoil banks to let surface water into the ditch. In some places it may be suitable to handle this water through a pipe outlet (Fig. 19-8).

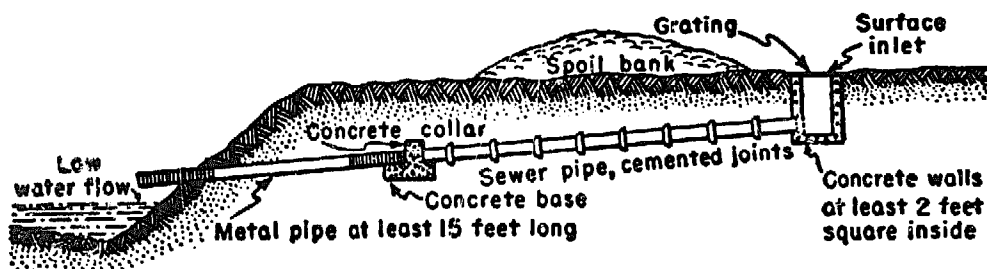

(Drawing: U.S.D.A. Farmers' Bulletin 2046)

Fig. 19-8. Pipe outlet under spoil bank to carry surface flow from low ground to drainage ditch. The water enters through a concrete inlet back of the spoil bank.

Structures Used with Open Ditches

Some means should be provided to let water down from a field ditch into the outlet ditch to avoid erosion back into the field. One way is to prepare a short grassed waterway or sod flume (Fig. 19-9). It is a broad channel lined with grass, sloping gently from the field to the ditch bottom. Slope in the flume should not be steeper than 6 to 1 and 10 to 1 is better.

Concrete or masonry structures can be used if sod will not do the job (Fig. 19-10).

Watergates

A watergate is needed where fences must cross an

open ditch. The gate must keep livestock from passing under the fence and at the same time not catch any floating plants or trash that would choke the ditch. A swinging gate, hung in sections from a cable or beam, answers the need (Fig. 19-11).

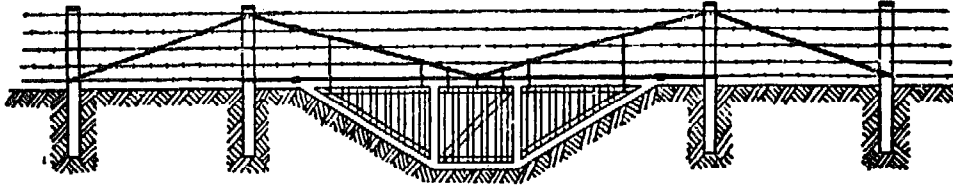

(Drawing: U.S.D.A. Farmers' Bulletin 2046)

Fig. 19-11. A three-section watergate, swinging from a cable that can be tightened if it sags. The gate is designed to confine livestock but pass floating debris.

7. Constructing Field Ditches

For surface drainage, ditches should be shallow and easy to cross. They should have side slopes that are no steeper than 8 to 1 and flatter if possible. Shallow ditches can be cultivated with the rest of the field.

There are two types of field ditches commonly used. They are the "single ditch," and the "double ditch" sometimes called "W" ditch or "twin ditches."

The single ditch is used where the excavated material is needed to fill depressions near the ditch or where the placement of the spoil on one side of the ditch will not interfere with the flow of surface water into the ditch (Figs. 19-12 and 19-13).

The "double" or "W" ditch (Fig. 19-14) is actually two parallel ditches spaced a short distance apart with the excavated material placed between the ditches. This permits surface water to enter the ditch from each side unobstructed. This type of ditch is particularly adapted (1) where the land drains toward the ditch from both sides, (2) where the land is very flat

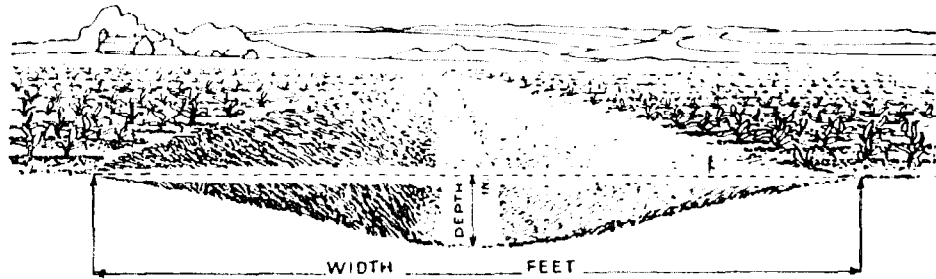

Fig. 19-12. The single field ditch is used where the excavated material can be used to fill depressions nearby. It has side slopes 8 to 1 or flatter to permit easy farming.

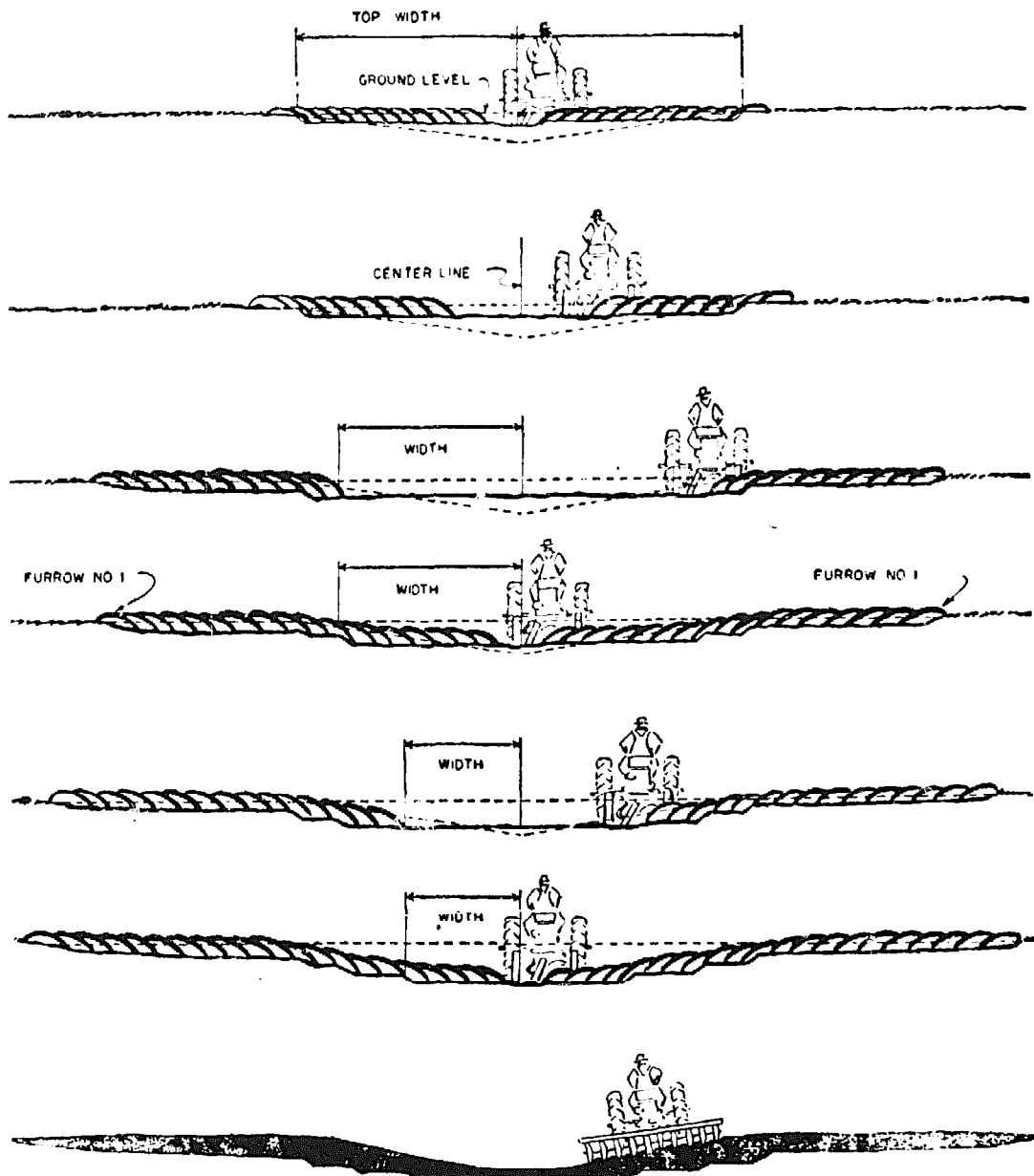
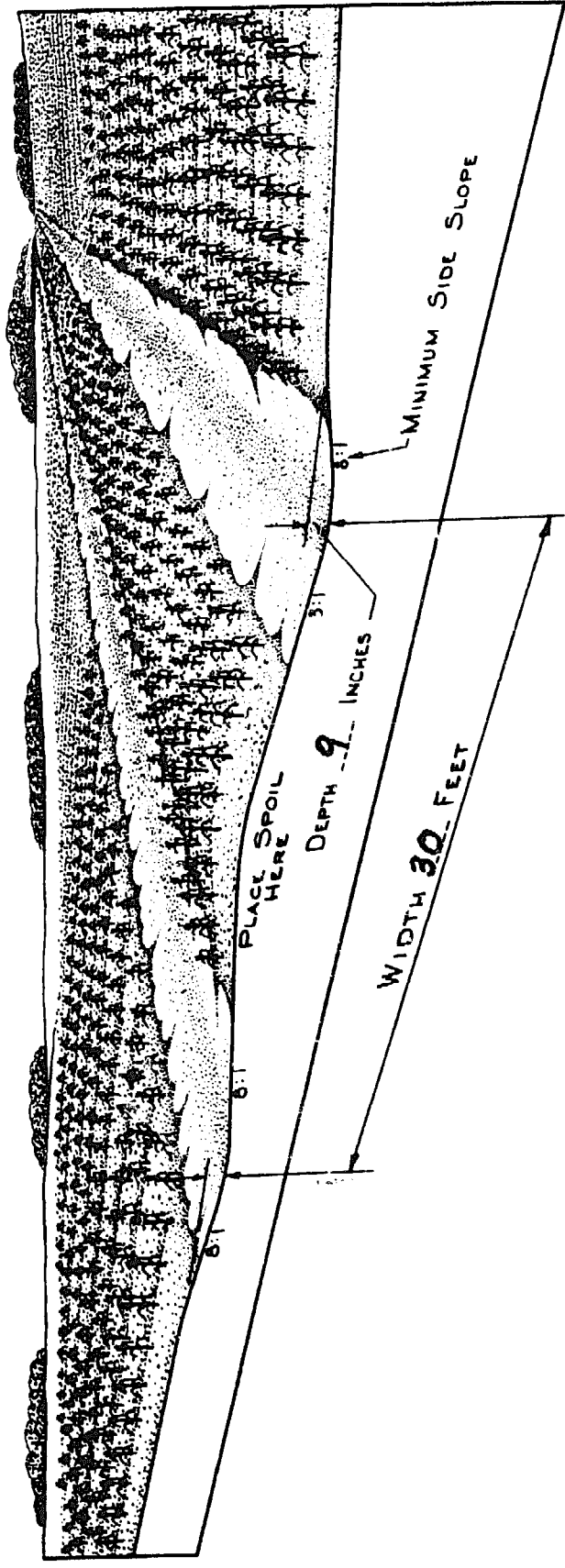
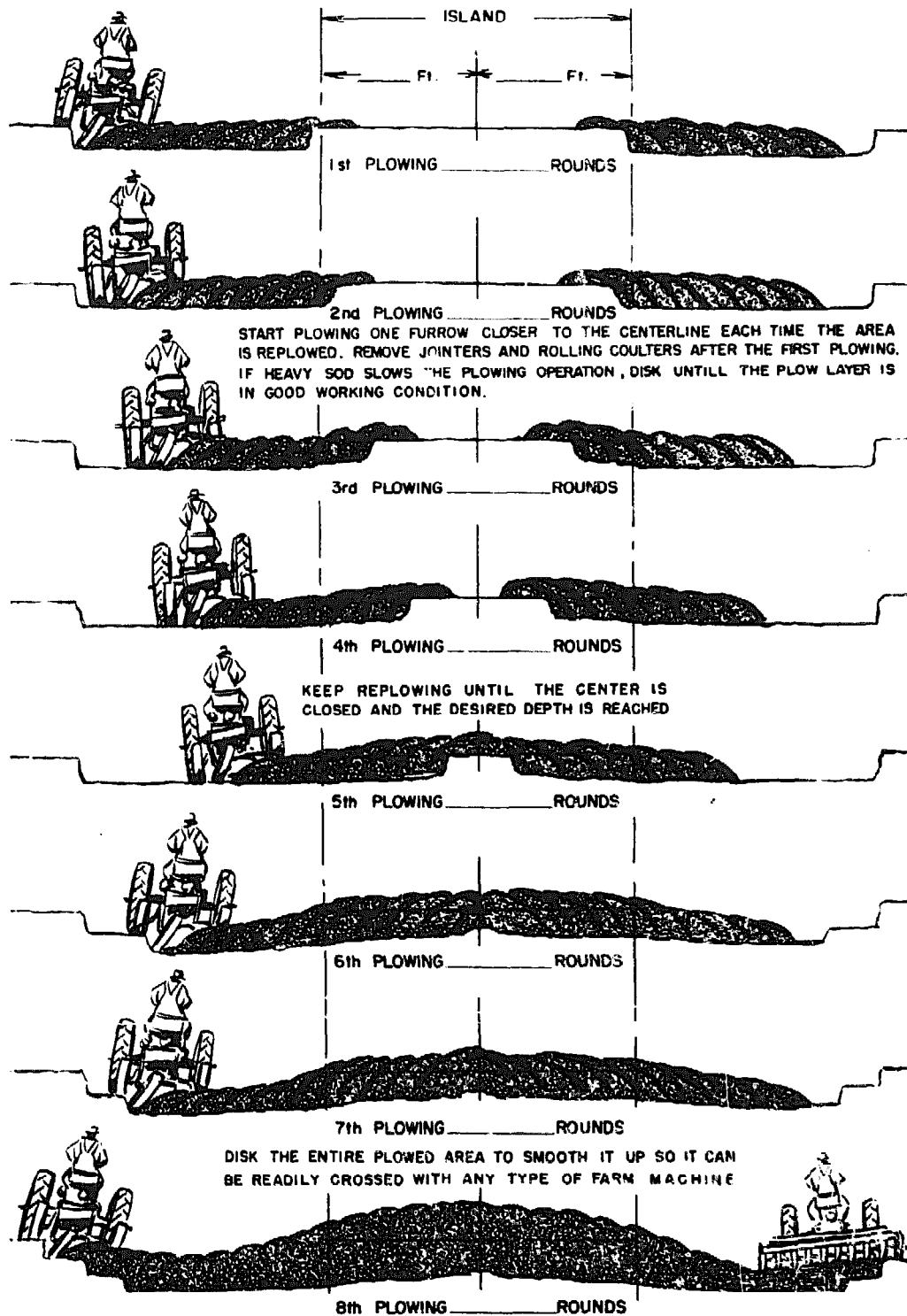

Fig. 19-13. Building the single field ditch with a plow.



(Drawing: U. S. Soil Conservation Service)

Fig. 19-14. The double channel "W" ditch or twin waterway.



(Drawing: U. S. Soil Conservation Service)

Fig. 19-15. Constructing the "W" ditch with the two bottom plow. The number of rounds depends on the distance between the ditches and the depth of the ditches.

and row drainage enters from both sides and (3) where excavated material will not be needed for filling depressions.

It is easy to build with a plow (Fig. 19-15). It can be farmed across or the area between the ditches planted to some other field crop or maintained as a hay strip. The crown between the ditches can also be used as a field road.

For the upper Mississippi Valley region the channels of the two ditches should be about 30 feet apart as a minimum for a channel about 9 inches deep. As the depth of the channel increases, the width between the ditches should be increased so that a side slope of about 8 to 1 or flatter can be maintained.

8. Staking Out Ditches

Staking is the first step in constructing open ditches. To do a good job and get the most effective drainage, you need several stakes for different purposes. Some stakes are used to establish the grade; others to mark the center of the ditch. "Slope stakes" mark the top width of the ditch. "Berm stakes" mark the toe of the spoil bank. All of these stakes are included under the term "construction stakes." These stakes, their uses, and the names they are commonly called are shown in Figure 19-16.

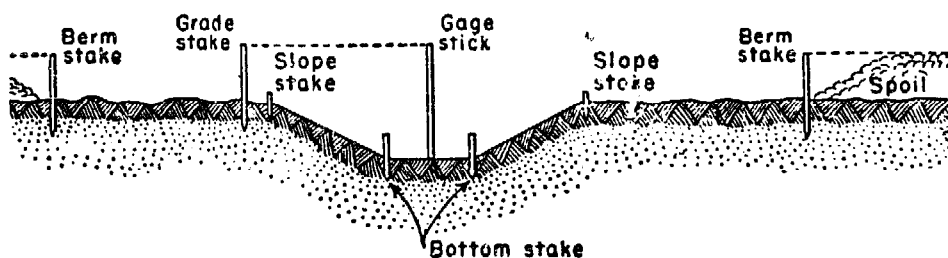

(Drawing: U.S.D.A. Farmers' Bulletin 2046)

Fig. 19-16. Cross section of ditch showing the location of the different kinds of construction stakes.

First set stakes along the center line every 100 feet where the ditch is straight and every 50 to 25 feet on curves. Then set grade stakes to one side of the ditch at 100-foot or shorter intervals with their tops at a uniform height, usually 5 feet, above the grade of the ditch bottom. Check these grade stakes by sighting to be sure that their tops line up properly.

To be sure the ditch is excavated to grade as construction work progresses, the depth of the ditch can be checked by sighting over the top of a gage stick held in the bottom of the ditch. The gage stick should have a length equal to the distance the tops of the grade stakes are set above the established grade of the ditch. When the ditch is excavated to grade, the top of the gage stick will be in line with the tops of the grade sticks.

Deep ditches—outlets and outlet ditches—are usually constructed with a drag line. Shallow single field ditches are built with plows, graders, or levelers. Twin ditches are usually built with graders or plows.

9. Maintaining Open Drains

To keep surface drainage systems working efficiently, ditches and outlets must be kept open so that water will move freely. Also, erosion must be controlled in the system itself and on the tributary area.

Control Bank Erosion

To control bank erosion, vegetation should be established on ditchbanks as soon as possible after they are dug. A good stand of grass properly managed will keep out shrubs and trees which can choke a ditch in a few years.

Silting of the ditches can be reduced by soil conservation practices on the land where the silt originates.

Use local grasses for ditch bank seedings.

Ditch banks make good wildlife habitat since cover, food, and water are available within a small area. The management of the ditch banks should take into consideration the habits of the beneficial wildlife so that they are not harmed.

10. Mowing and Pasturing Ditches

Where practical, mowing is a good way to maintain field ditches (Fig. 19-17). But a ditch must be designed for mowing. The side slopes should be flat and smooth enough for tractor operations. Slopes of $3\frac{1}{2}$ to 1 or flatter are necessary for safe operation of machinery.

Controlled pasturing with cattle and horses will keep drainage ditches free of brush and trees for a long time. Where it can be used, pasturing is one of the most effective and economical means of maintaining ditches (Fig. 19-18).

There are some places where grazing cannot be used.

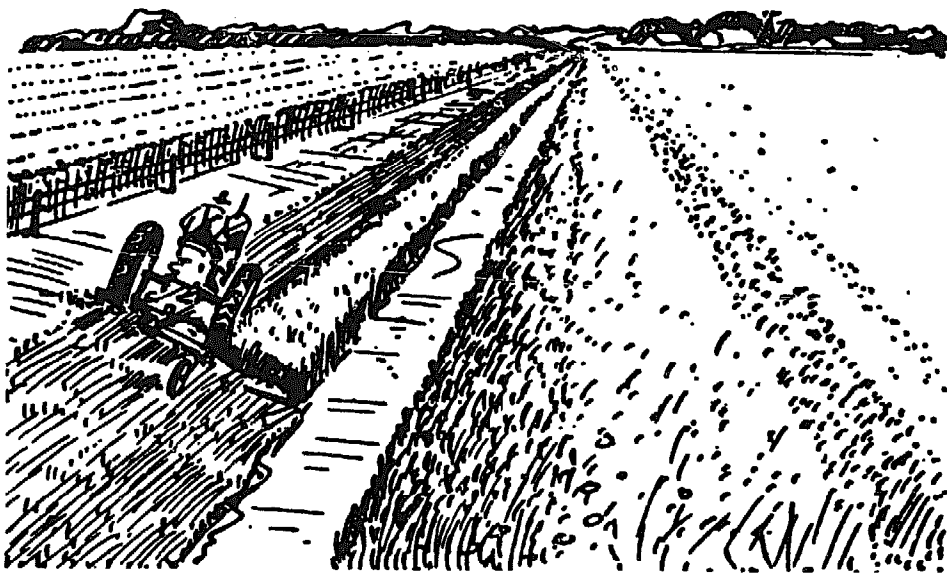

(Drawing: U. S. Soil Conservation Service)

Fig. 19-17. Mowing is an effective way to maintain good sod on ditch banks.

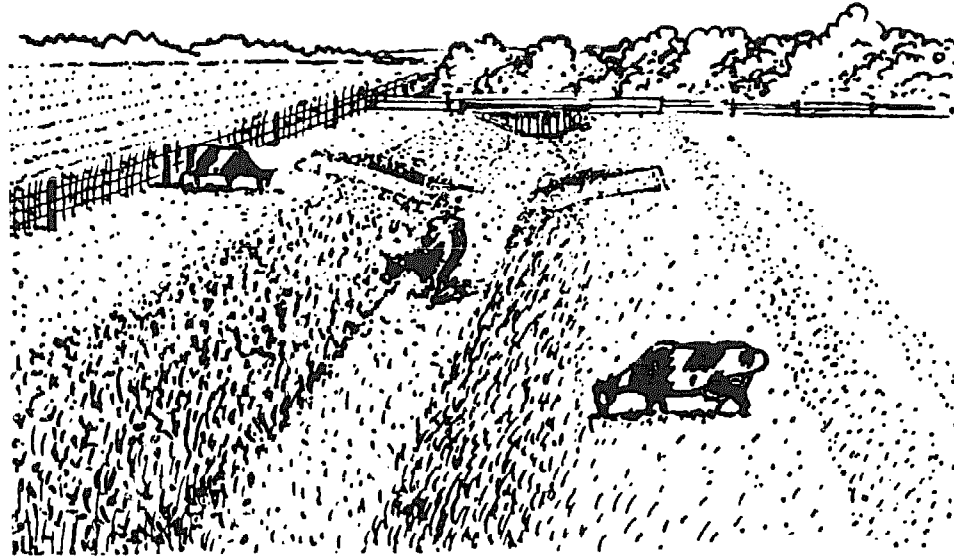

(Drawing: U. S. Soil Conservation Service)

Fig. 19-18. Pasturing of ditches is effective only when properly controlled.

Sandy soils, for example, do not produce good grass. Such ditches should not be grazed because the animals will cause more silting.

Stock should not be allowed to overgraze ditches. They should be kept out whenever the soil is saturated and during freezing and thawing weather. Keep hogs out of deep ditches at all times. They root the vegetation on the banks and cause erosion.

Vegetation in ditches may be controlled by spraying and burning if done properly. Spraying is particularly adapted to ditches with bank slopes too steep to mow (Fig. 19-19). Spraying should not be done on windy days because the drifting spray may damage adjoining crops. Wildlife should be considered when spraying ditches. For more detailed information on spraying see U.S.D.A. Farmers' Bulletin 2047, "Maintaining Drainage Systems."

11. Smoothing Land

Most surface drainage systems will be improved by

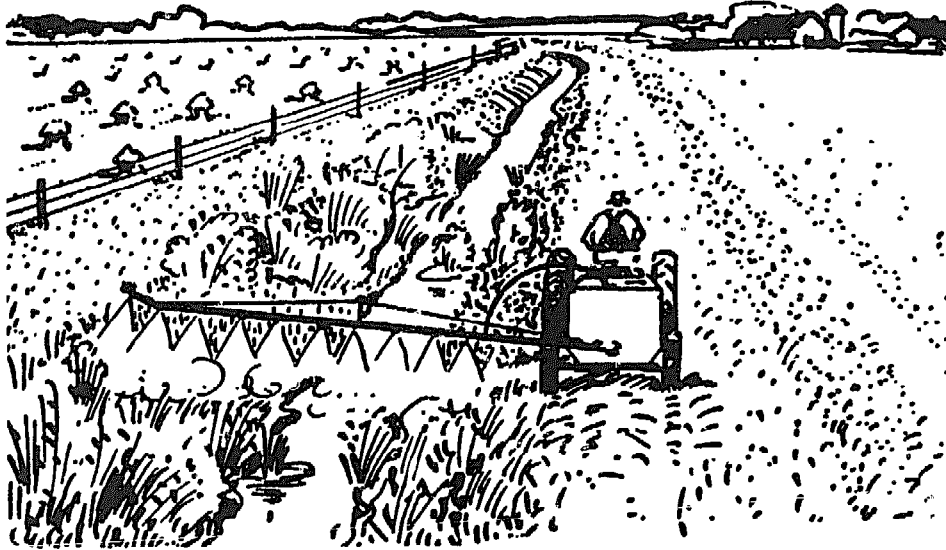

(Drawing: U. S. Soil Conservation Service)

Fig. 19-19. Spraying of ditch banks will control weeds, brush, and seedling trees when applied at the proper time with the correct chemical mixture and amount.

smoothing the land. Most of our tight and poorly drained soils are covered with depressions varying in size from small to large and in depth from almost nothing to a foot or more. In order to keep surface water moving it becomes necessary to ditch out these areas or fill them. Obviously it is impossible or impracticable to ditch out all the depressions. The larger ones, both as to size and depth, should be ditched out. This usually leaves many one- and two-inch pockets which will collect and hold water for long periods after rains, slowing up farming operations on the entire field and reducing or eliminating crop stands and yields in these low areas. The logical solution seems to be the ditching out of the larger depressions and filling the minor ones by land smoothing.

First the collection ditches should be laid out and constructed, using the spoil material from them to fill any low places within convenient moving distance. Then rough grade the area by eye, filling the larger

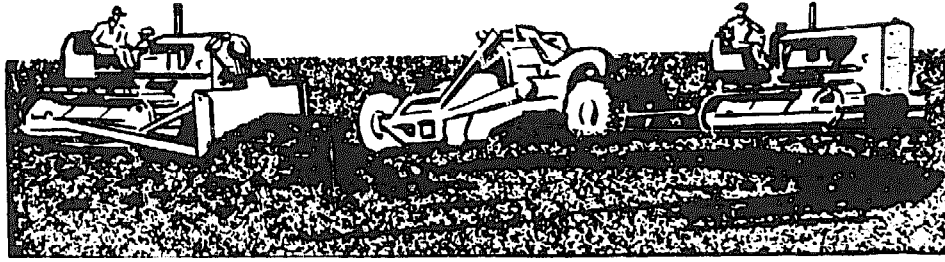

(Drawing: U. S. Soil Conservation Service)

Fig. 19-20. Use bulldozer or scraper to fill the larger depressions and pockets.

depressions with a bulldozer or scraper (Fig. 19-20). The next step is to operate a land leveler or land plane (Fig. 19-21) over the entire area, which will fill many of the minor depressions and remove the small high points. The leveler should be run over the areas from 2 to 3 times depending on the roughness of the land. Experience has shown that it pays to operate the leveler over the field diagonally in two directions the first two times over and the third time in the direction of the greatest slope. Additional trips may be made depending on the need.

Unless the field has been plowed recently, covering all crop residue, the ground should be worked with a disk harrow, bush or bog disk, field cultivator, or similar tool immediately before using the leveler or plane.

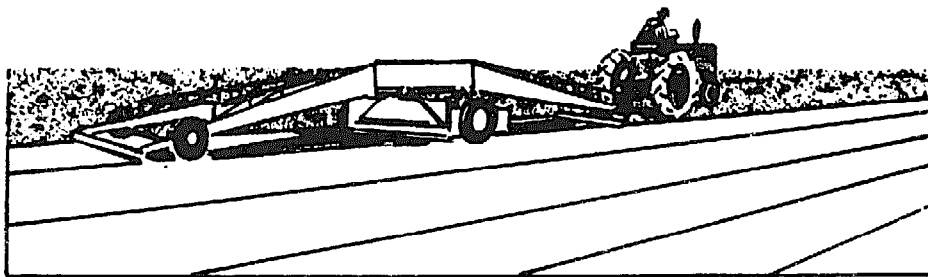

(Drawing: U. S. Soil Conservation Service)

Fig. 19-21. A land leveler or plane for filling small pockets and smoothing the ground.

This facilitates the movement of dirt by the leveler and mixes crop residue into the soil which prevents vegetation from collecting and hanging on the leveler blade. If the area is in a stiff sod it should be plowed 3 to 6 months ahead of the smoothing operation or farmed in a cultivated crop one year before smoothing.

After smoothing, a plan of surface ditches should be prepared and the field ditches laid out and constructed.

Observe Closely First Year

Watch the area closely during the first year of cropping to determine the places that need further attention. The second year additional filling and leveling may be needed.

Keep in mind that it is not necessary that grading work be carried to the point of obtaining a uniform slope over long distances. The primary purpose is to grade the field so that it will drain, filling in the depressions and removing the humps. The slope can change when it will reduce the amount of earth to be moved.

Land smoothing will add to the cost of a surface drainage system but experience has shown that increased crop yields will pay for the cost in a relatively short time.

12. Using Underground Drainage

Underdrains drain the soil rather than the surface. They take out only excess water, not water that plants can use. The excess water flows by gravity into the drains and is carried through them to an outlet. Underdrains have definite advantages over surface drains. They occupy no land surface. And they do not harbor weeds or interfere with farming operations. Underdrains do not carry off surface water rapidly unless

surface inlets are provided and such inlets should be used with caution.

Use Tile Drains

Tile is the common material used for underdrainage. When properly selected and installed, it becomes a permanent improvement which needs only slight care afterward.

Water moves into tile drains by gravity. It enters through the joints between the tiles, not through the walls as many people suppose.

Planning, laying out and installing a tile system is a precise job. Grades must be exact or the water will not flow through the tile. And once installed, errors cannot be corrected as might be done with surface ditches.

Make a Complete Survey

A complete survey of the field to be tiled must be made in order to plan the most efficient layout of laterals and mains. Accurate grade of the main must be determined because the size of the main depends on its grade and the number of acres to be drained through it.

If the land is rolling, tile lines may be laid in the low places in a random system with extra branch lines as needed in wide wet areas.

Where the land is uniformly too wet for cultivation, it is better to construct a complete tile system. The main drains follow generally the natural watercourses of surface flow; the laterals are laid in parallel lines or groups of parallel lines under the whole area. The laterals should be straight and run in the general direction of greatest slope. They should be laid at such intervals and at such depths as the soil requires.

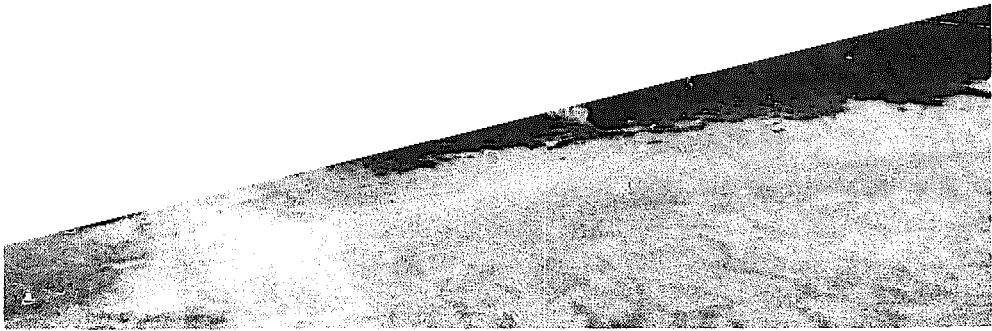

(Photo: U. S. Soil Conservation Service)

Fig. 19-22. Corrugated metal pipe that will empty into the drainage ditch without eroding the ditch bank.

Use Short Mains

A system of short mains with long laterals is most economical. As with surface drainage, the outlet is the key to the success of the whole system. For upper Mississippi Valley conditions the outlet must be low enough to permit the placing of tile 3 to 4 feet below the surface on the low areas of the field. Where the outlet tile empties into the ditch, the ditch should be low enough so that there is at least a foot between the bottom of the tile and the low water flow in the ditch.

The outlet must be protected against washing or eroding of the ditchbank. One method is to extend a section of metal pipe out beyond a support so that the water falls into the ditch far enough from the ditchbank to be safe (Fig. 19-22).



(Photo: U. S. Soil Conservation Service)

Fig. 19-22. Corrugated metal pipe that will empty into the drainage ditch without eroding the ditch bank.

Protect Outlet

The end of the outlet should be protected to keep out small animals. A hanging screen or metal gate should be used, especially where there are surface inlets in the line, because one fixed rigidly will catch trash washed down the drain and obstruct the outflow (Fig. 19-23).

13. Determining Size of Tile

The proper size of tile for mains and for laterals depends on several factors. In the first place, where surface channels carry off a large part of the water during a rain, tile drains have to provide for only that part that seeps into the soil.

If surface water is admitted to the tile system through open inlets, the tile must be made large enough to handle it.

The flatter the grade the larger must be the tile. And finally, the needed size depends on the size of the area drained. See local drainage specialists for determining size of tile main.

Five-inch tile is recommended for laterals especially in sandy soils or on flat grades of less than 0.1 per cent, or for that portion of the line over 1300 feet. Six-inch tile is recommended for muck.

14. Spacing Tile

Tile drains should be spaced so as to lower the ground water enough for good plant growth within 24 hours after a rain. They lower the ground-water surface in a curve that is lowest at the drains and ordinarily highest midway between them (Fig. 19-24).

The rapidity with which drains lower the water depends on how easily water moves through the soil.

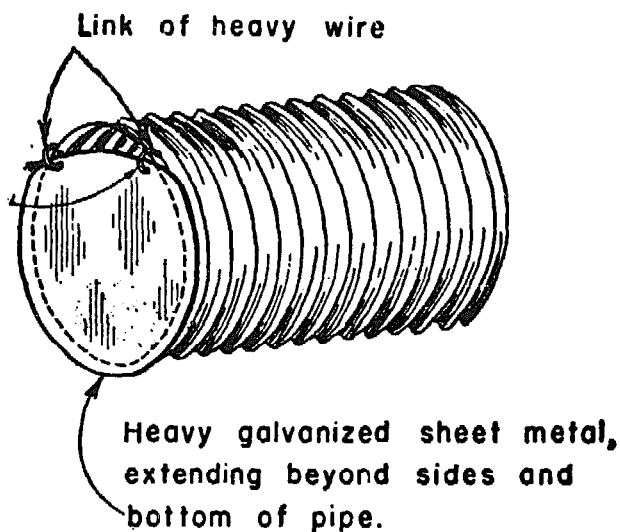
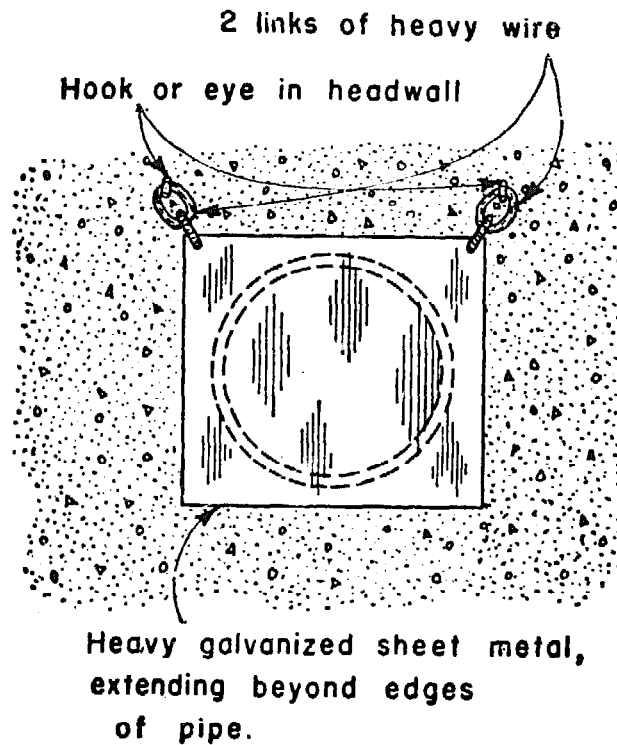

(Drawing: U.S.D.A. Farmers' Bulletin 2046)

Fig. 19-23. Simple sheet-metal gate to keep small animals out of tile drains. Top, attached to a headwall outlet; bottom, attached to a corrugated pipe outlet.

The soil's texture and structure affect this rate. In sandy land the drains can be placed farther apart and deeper than in clay soils. In tight clay soil the movement of water is very slow, and tiles must be placed at

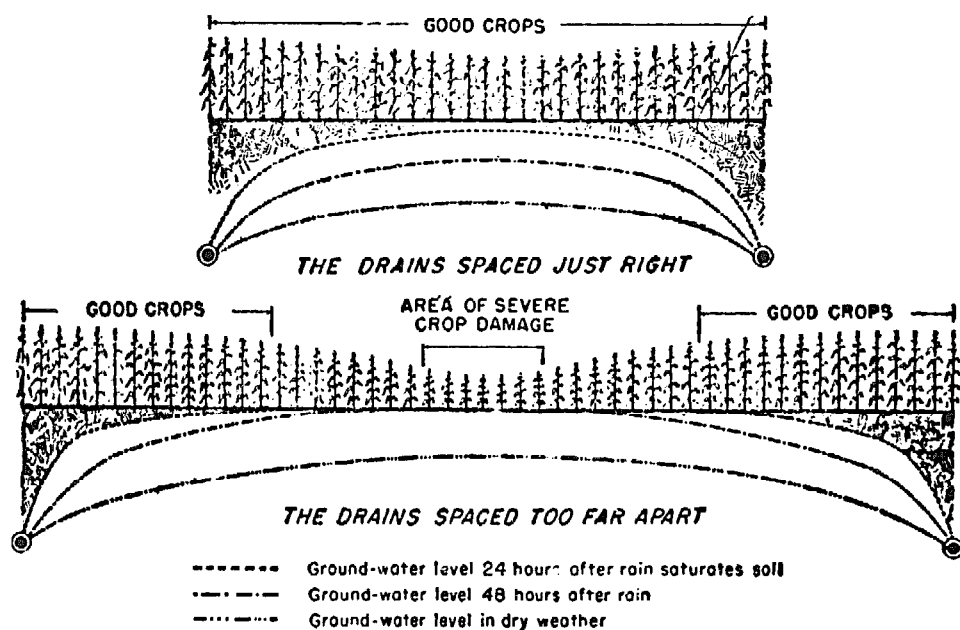

(Drawing: U.S.D.A. Farmers' Bulletin 2046)

Fig. 19-24. How spacing of tile drains affects ground-water level and crop damage.

less depth and closer together than in soil with more open texture.

In the humid region of the U. S. in clay and clay loam soils, distance between tile lines may have to be as close as 40 to 70 feet and 2½ to 3 feet deep. No tile should be laid less than 2½ feet deep; that is, the bottom of the trench should be at least 2½ feet below the ground surface. Large tile should be laid deeper. Cover the tile with at least 24 inches of earth to prevent breakage by heavy machinery.

In silt loams the lines can be 60 to 100 feet apart and 3 to 4 feet deep.

In sandy loams, tile spaced 100 to 300 feet apart and 3½ to 4½ feet deep may give good results. A spacing closer than 50 feet usually makes drainage too costly unless the land is to be used for truck or other high-value crops. For irrigated lands, in arid regions, tile is laid much deeper.

All tile should be laid deep enough to be free from frost damage.

15. Selecting Tile

Tile used in underdrains must be strong enough to withstand the pressure that will be put on it. Locating and replacing broken tile in a drain is difficult and costly.

Buy Tile that Meets Specifications

The American Society for Testing Materials has prepared specifications for drain tile. In buying tile, it is a good idea to make clear in the contract that the tile furnished must meet those specifications. Both clay tile and concrete tile are included.

Concrete tile is used widely in the West. Where properly made, it is satisfactory in soils free from acids and alkali salts.

Check the individual tiles and reject those with deep cracks, large checks, lime spots, pebbles, and honey-combed walls, as well as those out-of-round or warped.

16. Staking Out Tile Drains

U.S.D.A. Farmers' Bulletin No. 2046, "Farm Drainage," gives the following method for staking out a tile line:

Stake out the drains by setting stakes at 50-foot intervals. At each 50-foot station should be two stakes—a hub or grade stake with its top about at ground level and a guard stake standing a foot or more above ground (Fig. 19-25).

The grade hub is a marker from the top of which all measurements are made. The grade hub, therefore,

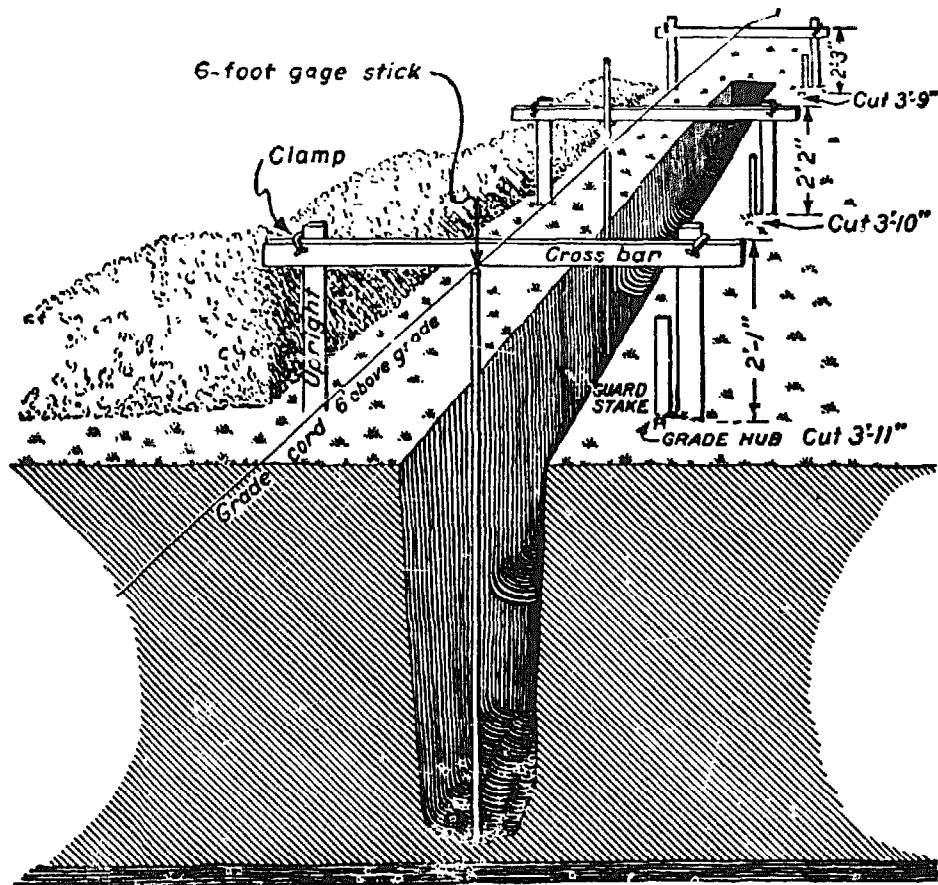

(Drawing: U.S.D.A. Farmers' Bulletin 2046)

Fig. 19-25. Gage-and-line method of establishing grade for a tile drain. A cut of 3 feet 11 inches is indicated at the hub in the first station. Subtracting this cut from the length of the gage stick (6 feet), the difference of 2 feet 1 inch is the height for setting the top of the cross bar above the hub. The gage stick at the first station shows that the trench has been dug to the correct elevation at that point. The gage stick at the second station shows that more digging is required for the needed cut of 3 feet 10 inches.

should be set firmly. The hub elevations should be determined accurately.

The guard stake locates and gives the number of the hub, and on it may be marked the required depth of cut below the top of the hub. Determine this depth by subtracting the elevation of the designed trench bottom from the elevation of the hub.

It is imperative that there be no sags in the com-

pleted tile line. Silt is likely to settle in any depression and cause partial or even total clogging of the drain. Therefore, the leveling must be very accurate.

17. Trenching with Machinery

Power-operated trenching machines are of two types, wheel excavators and endless-chain excavators. The wheel excavator is more commonly used in farm-drainage construction.

Proper depth is maintained by keeping a sight bar on the machine in line with targets set at least 3 targets ahead of the machine. These targets are long stakes or rods driven vertically near the grade hubs. Each has a level cross bar at a height above the grade line equal to that of the sight bar on the machine. A string attached to the targets may be used to make a line for the machine to follow.

18. Trenching by Hand

The tools most commonly used in trenching and laying tile by hand are tile spades, shovels, drain scoops, tile hooks, and gage sticks (Fig. 19-26). The gage stick is a straight stick 1 by 2 inches in cross section and 5 or 6 feet long. Six feet is the usual height for convenience in working under the cross bars. A braced T-piece on the bottom aids in setting the gage vertical.

19. Establishing Grade

The best method of establishing grade for hand trenching is probably that of gage and line (Fig. 19-25). This consists of stretching a cord at a uniform height above the bottom of the trench to be dug and measuring down from it with a gage stick.

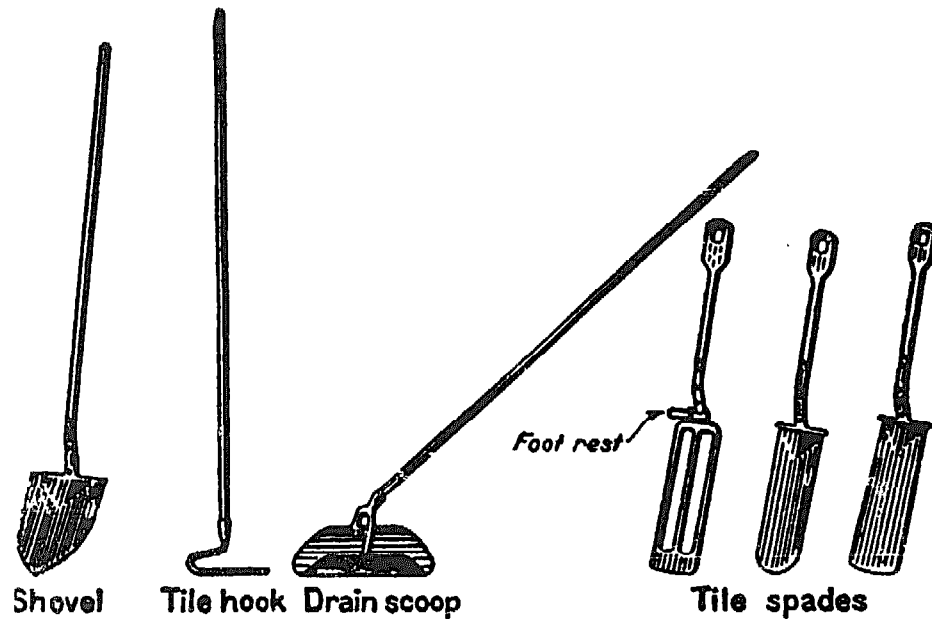

(Drawing: U.S.D.A. Handbook 135)

Fig. 19-26. Hand tools for tile-drain construction.

Measure from Top of Crossbar

To set the grade cord at the right elevation, at each station set two strong stakes upright near each grade hub, one on each side of the drain line. To these uprights fasten a cross bar. To determine the height of the cross bar, subtract from 6 feet (or from the length of the gage stick) the cut measurement at each hub stake. This gives the height to place the cross bar above the top of the hub. All measurements are from the top of the cross bar. Use a carpenter's level to set the cross bar level.

Fasten the cross bars with a clamp for convenience in adjusting. Set similar cross bars at three or more stations. If the fall in the drain is uniform, you can detect any error in setting the cross bars by sighting over them.

Next, across the tops of the bars, over the center line of the trench, stretch a light, strong cord. Keep the cord taut by hanging a weight on each end.

The trench bottom is at correct grade when the gage stick is upright in the trench and its top just touches the grade cord. The bottom of the gage stick must be kept clean; any adhering dirt will result in incorrect grade.

20. Digging Trenches

Begin digging the trench at the outlet and proceed upgrade. This lets any water that gets into the trench flow away and keeps the trench dry and firm. See Figure 19-27 for method of using the tile spade.

Tile must be laid in straight lines and smooth curves to be most effective and least likely to become obstructed. To do this, stretch a guide line or rope along the ground about a foot to one side of the grade hubs, making smooth curves at all bends. Mark the edge of the trench along this line with a spade. This is important because if the first spading is a little off, it is practically impossible to smooth up the line on later spadings.

For small tile, dig trenches 12 to 15 inches wide, with the sides practically vertical. Dig them with tile spades

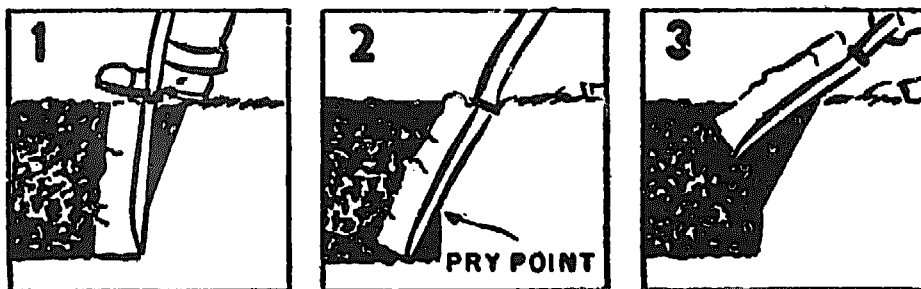

(Drawing: U. S. Soil Conservation Service)

Fig. 19-27. In using the tile spade, first drive the blade obliquely for three-fourths of its length, push the handle forward and drive vertically to its full length. This leaves a hump of earth near the bottom to serve as a fulcrum for using the spade as a lever. Then pull the handle back and lift the loosened load from the trench.

to within 1 or 2 inches of grade; then clean out the bottom to the correct grade with a tile scoop (Fig 19-28). Most tile trenches are 2 or 3 spade blades deep. Be sure the tile scoop used is of suitable size for the tile being laid. The 5-inch size meets most of the requirements for ordinary farm work.



(Drawing: U. S. Soil Conservation Service)

Fig. 19-28. Using the tile scoop to finish the trench bottom.

21. Laying Tile

As in digging, start laying the tile at the lower end or outlet and progress up grade. In placing tiles, turn them until they fit closely together. If a tile is crooked or the ends are irregular, turn it until it fits tightly at the top and the open space is left at the bottom. Where a crack or opening of as much as $\frac{1}{4}$ -inch must be left at the top or sides, cover it with pieces of broken tile, a strip of roofing paper, or, in some sandy soils, cement mortar.

Tiles that fit very closely together, leaving little space for water to enter, should be spaced about $\frac{1}{16}$ to $\frac{1}{8}$ inch apart. But where fine sand is likely to be washed into the drain, the tile should be fitted closely.

Be sure that changes in direction are made by curves and not by sharp angles. Keep the curves regular, with the outer side of the joints covered with pieces of broken tile (Fig 19-29).

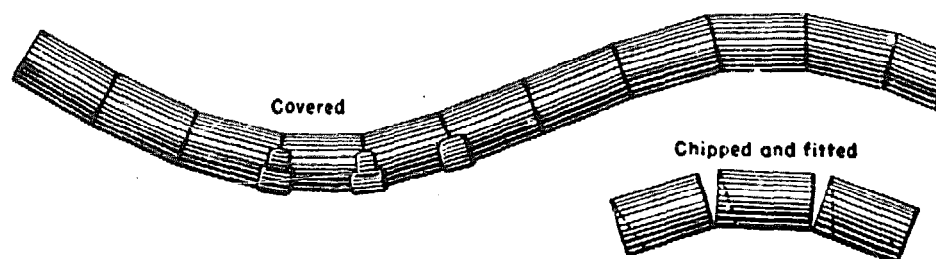

(Drawing: U.S.D.A. Farmers' Bulletin 2046)

Fig. 19-29. Curves in tile lines.

22. Blinding Tile

Cover the tile as soon as they are laid with 4 to 6 inches of topsoil (Fig. 19-30) where the topsoil is free from sand. This holds them in position and permits water to enter the tile freely. This is called blinding the tile. Work the earth under the sides of the tile to give them support and prevent displacement when the trench is backfilled. But take care not to compact the earth about the joints.

23. Backfilling Trenches

After blinding, the trench should be backfilled. A bulldozer blade mounted on the farm tractor makes a convenient tool for backfilling (Fig. 19-31). Be sure the trench is backfilled above the normal ground level to allow for settlement.

24. Using Location Map

A map of each field that shows the location and size

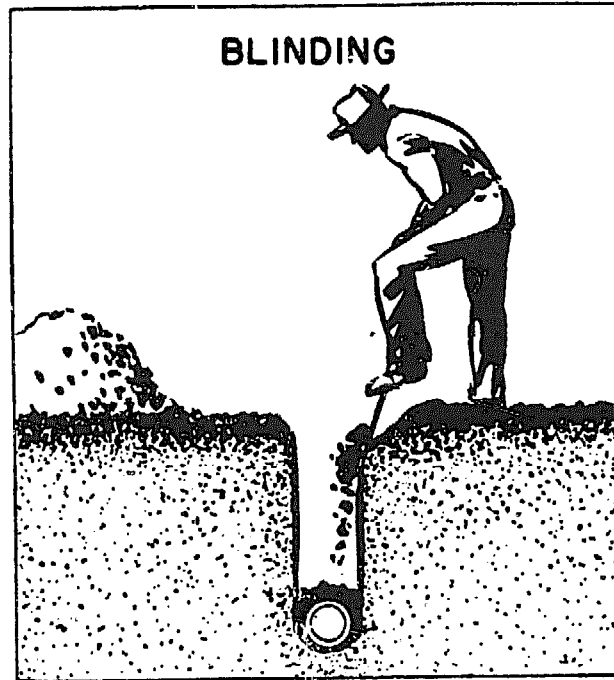

(Drawing: U. S. Soil Conservation Service)

Fig. 19-30. Blinding the tile with topsoil. This permits water to enter the tile freely.

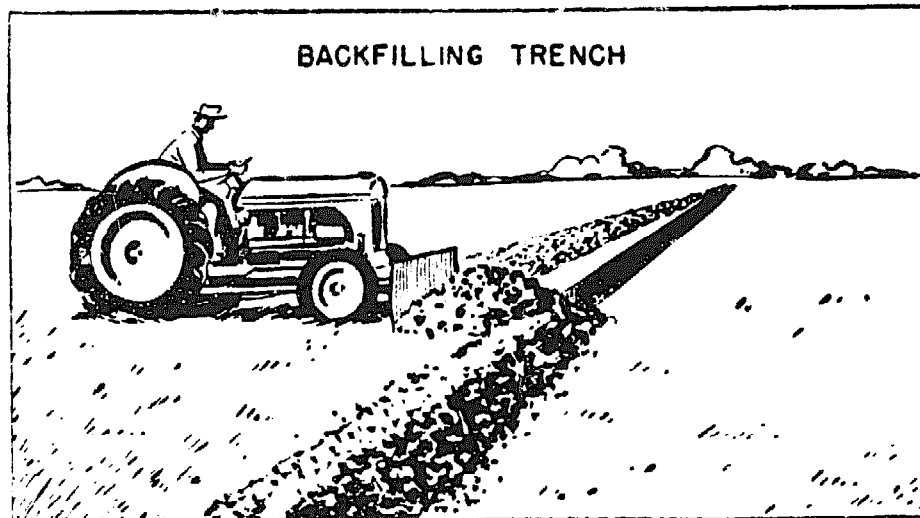
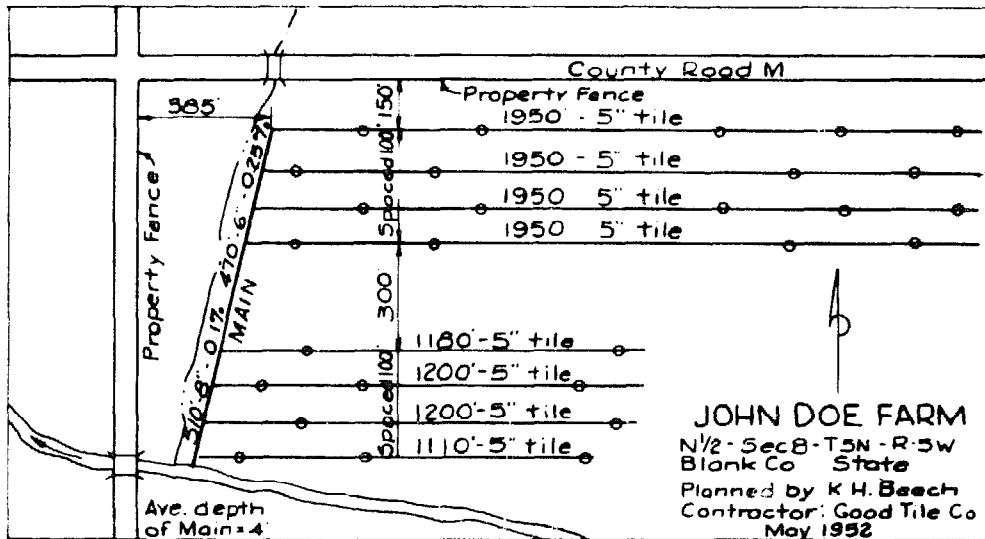

Fig. 19-31. Backfilling may be done with a regular farm tractor and small bulldozer.



(Drawing: U. S. Soil Conservation Service)

Fig. 19-32. Sample map of a field showing the location and essential information concerning the tile system.

of all tile lines and the depth and grade of the main is very important (Fig. 19-32). Such a map will save many times its cost by helping you locate breaks and stoppages. If you decide to add more lines you will know where to put them. It is a record of the capital investment represented by the tile system. It is a good idea to attach a copy of the map to the farm deed.

Chapter

XX

CONSERVATION IRRIGATION

Irrigation is such a broad subject and there are so many ways of irrigating that we can only touch on some of the main principles here. For more complete information on irrigation you will need to check the publications from your agricultural college and the U. S. Department of Agriculture and consult the technicians of the Soil Conservation Service and other agencies working with irrigation and water problems.

A Suggested List of Activities Involving Approved Practices

1. Conserving Soil by Proper Irrigation
2. Controlling Irrigation Water
3. Solving Irrigation Problems
4. Fitting Irrigation Methods to Land, Crops and Water Supply
5. Supplying Supplemental Irrigation

1. Conserving Soil by Proper Irrigation

We cannot talk about approved practices in conservation without talking about conservation irrigation. According to Agriculture Information Bulletin No. 8 of

the U. S. Department of Agriculture, soil erosion is as great a menace to irrigated land in arid regions as it is to land in humid regions. Moreover, in arid regions soils are generally low in organic matter, which leaves them highly subject to both wind and water erosion.

This bulletin points out that erosion is threatening the continued productivity of more than half of all the irrigated land in the West. Part of this is caused by the attempt to grow crops on land not suited to crops—wrong land use. (See Chapter I.) But most of this damage results from misuse of irrigation water.

In addition to erosion damage, uncontrolled irrigation water also causes serious drainage problems and salt accumulation on many irrigated bottom lands. Or, if the surplus water passes through the root zone, it leaches out the plant foods. Where the water collects to form wet spots, alkali salts may concentrate. Some of this alkali land is still being farmed, but with reduced yields and less profitable crops.

Not only does this result in a loss of land but every gallon of water that is either pumped or purchased is money wasted out of the farmer's pocket when the water is wasted. This waste increases the cost of producing crops, in addition to the damages his land and crops may suffer.

Soil structure is broken down in fields where row crops have been grown too long. The combined effects of this broken-down soil structure, erosion, and depleted organic matter have made these fields less and less able to take water. Their productiveness is on the downgrade.

2. Controlling Irrigation Water

Much of the damage to irrigated land is due to irrigation runs that are too long. Long runs also con-

tribute to water waste and leaching. To get water to the lower ends, the upper ends must be over-irrigated.

Delivery of irrigation water in open ditches contributes heavily to water loss. This loss may be as much as 70 per cent. The average in the West is about one-fourth of the volume of water carried. Most of it is due to seepage. If seepage water is not recovered by return flow, it is lost to agricultural use. Heavy weed growth in canals slows down the flow of water—besides reducing the capacity. And this reduced velocity increases canal losses from both evaporation and seepage.

Improper methods of logging and heavy grazing on the watersheds that produce irrigation water have created other problems. Streams that once gave a steady water supply throughout the growing season now flood more often in the spring and deliver less water during the rest of the year. Silt carried down from these unprotected watersheds is filling many reservoirs and adds to the debris that must be removed from irrigation and drainage canals.

Over-irrigation, running water down steep slopes and other mistakes in the use of irrigation water can cause damage in the humid areas, too. This is becoming more important as more and more farmers in the humid areas of the country are irrigating crops to supplement the normal rainfall.

3. Solving Irrigation Problems

There are practical ways to solve most of these problems. They involve basic principles of soil and water conservation. And they require an accurate knowledge of soil, topography, water needs, and the capability of the land to be irrigated.

An irrigator practicing conservation irrigation has control over his irrigation water from the time it en-

ters the ditches and on down until a small part leaves as waste water. He is able to apply the water in such a way that it wets the root zones of his plants with the least practicable loss from runoff or from deep percolation.

On many farms a different method of irrigating is needed. Some also need drainage, supplemental water supplies, or land leveling.

Soil-building crops in rotation with cash crops need to be grown more extensively to add organic matter to the soil.

Reforestation and better range management are needed for some watersheds.

Practice Conservation Irrigation

Conservation irrigation on the farm is simply the use of the irrigation and cropping methods that best fit the particular soil, slope, crop, and water supply. It makes possible irrigation without erosion damage, alkali accumulation, waterlogging, or undue water loss.

What you need to know in order to irrigate properly are: (1) the water-holding capacity of the soil; (2) the infiltration rate of the soil—how fast it will take water (don't apply water faster than the soil can take it); (3) the depth to irrigate, which depends on the root zone of the plants being irrigated; and (4) how fast the plant uses water.

The following steps will enable any farmer to establish conservation irrigation on his farm:

Get an Inventory of the Soil and Water Resources

The soil on the farm needs to be examined for depth, texture, structure, permeability, available water capacity, and productivity. A soil conservation survey map showing these and other factors, such as slope, past erosion, and seep spots, will provide the required detail. You also need to know what water is available on

the farm and how it is made available through the irrigation season. If the water supply is not adequate, possibilities for improving it should be studied before making plans for the farm.

Decide How to Apply the Water

The methods used to apply the water must fit the land. Also, they must fit the crops you wish to irrigate. Finally, they must fit the water available.

Plan the Distribution System

The farm irrigation system must be designed to get enough water to all parts of the farm when needed. It should also provide for the safe disposal of any waste water.

Prepare the Land

The fields must be prepared so that water can be applied with maximum efficiency. Some land may need to be leveled.

Adjust the size of water streams so that they will not cause erosion but will apply just enough water to satisfy demands. Where there is alkali in the water, you may need special methods to prevent its concentration in the plant root zone.

4. Fitting Irrigation Methods to Land, Crops, and Water Supply

The water supply, the soil, the topography, and the crops to be irrigated determine the correct methods for applying irrigation water. Conservation irrigation requires careful attention to all these factors.

The ability of different soils to take in and hold water varies greatly. Some soils absorb and hold large

TABLE 20-1. Where some common irrigation methods fit in conservation irrigation.

Method	Adapted to—	Conservation features
Basins.....	Close-growing crops on flat land	Provides good control of water applied. Good for alkali control.
Borders.....	Hay or grain on uniform slopes up to 3 percent; established pasture on uniform slope up to 6 percent. Best adapted medium light soils.	Provides uniform wetting and efficient water use. Utilizes large water streams safely and thus less time is required to cover area.
Corrugations....	Close-growing crops on sloping land with soil slow to take water. Extreme care is needed in applying water to slopes of more than 2 percent.	Provides uniform wetting and prevents erosive water accumulation on land too rolling or steep for borders or basins. Makes use of small streams.
Furrows.....	Row crops, truck crops, orchards, vineyards, and berries on gentle slopes with all but coarse-textured soils.	Provides no conservation features unless furrows laid on nearly level land on the contour and water applied with extreme care.
Sprinklers.....	Nearly all crops on any irrigable soil except in very windy hot climates.	Provides uniform wetting, eliminates erosion, and gives high water use efficiency in most places.
Controlled flooding.....	Close-growing crops on rolling land; pasture sod established by corrugations or sprinklers.	Provides water control and fairly uniform wetting where land cannot be used for other methods.

quantities. Others take water very slowly or have little holding capacity.

Know Your Soil

A thorough knowledge of the way your soils absorb water and the capacity of different soils on your farm

to store water is vital to conservation irrigation. If you apply more water to a particular field than it can readily absorb, you invite both expensive water waste and erosion. You may also risk bringing harmful alkali to the surface. Knowledge of the water-holding capacity of the soil makes it possible for you to apply just enough water to satisfy the needs of growing crops but not enough to cause waste and damage.

Fit Cropping Program to Water Conditions

Once you know the water-intake rates and the storage capacity of your soil, and the amount of irrigation water available and the method of delivery, you can adjust your cropping program to these conditions.

Basin Irrigation (Figs. 20-1 and 20-2)

The purpose of this method is to fill a diked area of



(Photo: U. S. Soil Conservation Service)

Fig. 20-1. Contour basin irrigation in Stanislaus County, California.

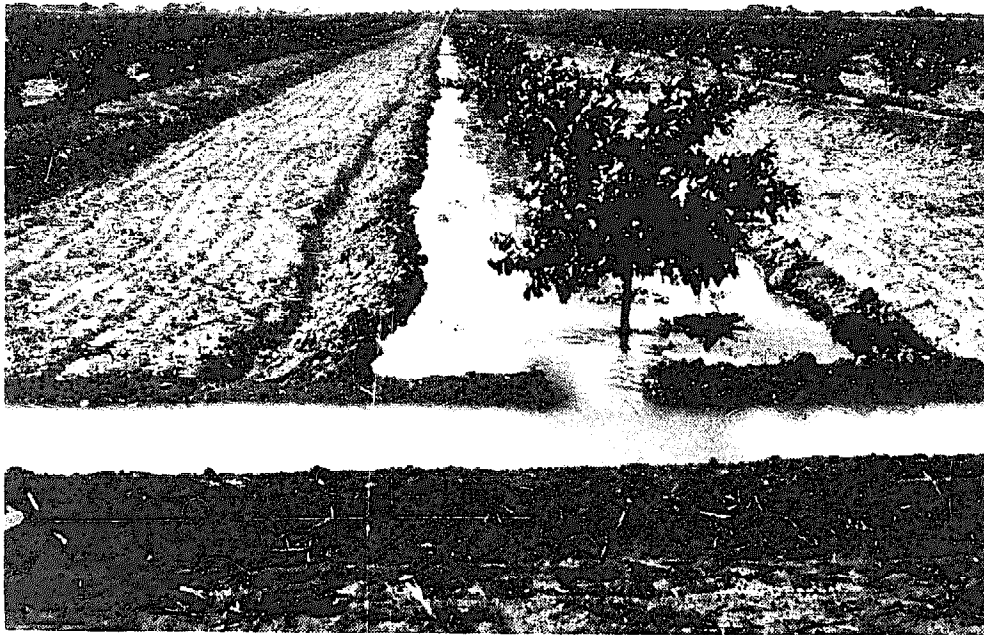

(Photo: U. S. Soil Conservation Service)

Fig. 20-2. Straight basin irrigation near Raymondville, Texas. Irrigating young citrus trees.

land with water to the desired depth quickly and allow the water to go into the soil. When basins are properly graded and built to the right dimensions for the kind of soil and the water supply, water can be applied efficiently.

Border Irrigation (Fig. 20-3)

This is a controlled way of flooding the surface of a field. The idea is to advance a sheet of water down a narrow strip between low ridges or borders and to get the water into the soil as the sheet advances. It requires that the strip be well leveled between the border ridges and the grade down the strip be fairly uniform to avoid ponding. The ridges should be low and rounded so they can be planted with the strips. Then no land is taken out of production.

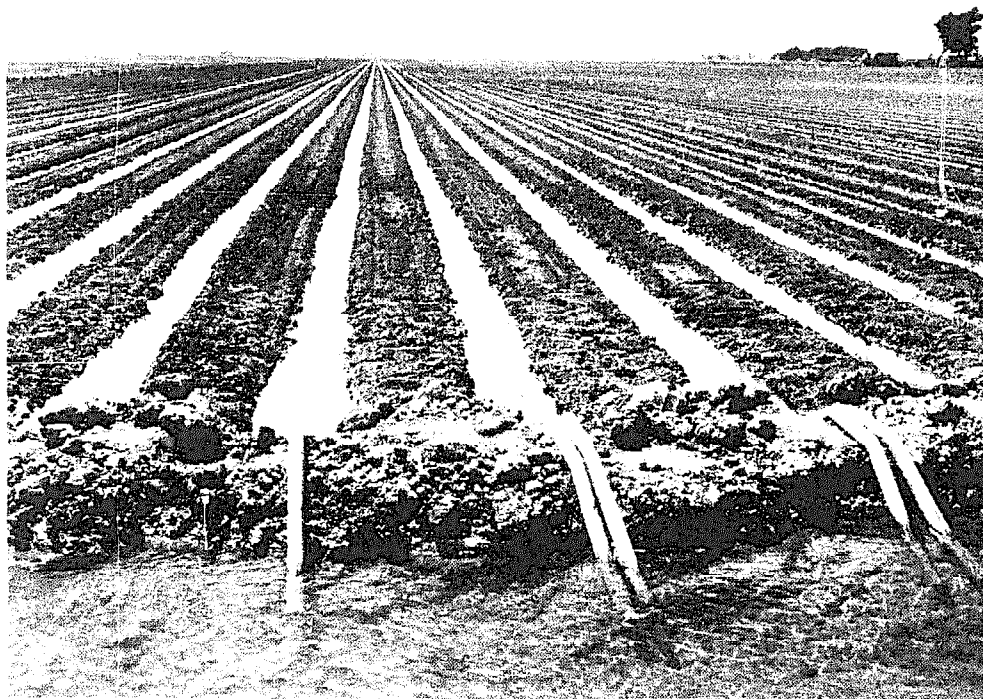

(Photo: U. S. Soil Conservation Service)

Fig. 20-4. Straight furrow irrigation of carrots in California. Water siphoned from head ditch by means of spiles.

Furrow Irrigation (Fig. 20-4)

Furrow irrigation is the most common method of irrigating row crops. The water is applied in the furrows between the plant rows. Many of the present furrows are too steep for safe irrigation. This fact has been the greatest single cause of erosion by irrigation water. Because cultivation to control weeds keeps the soil in the furrows loose, it is easily eroded.

Contour-Furrow Irrigation (Fig. 20-5)

This is the method of applying water in furrows across rather than down sloping land. The furrows are given just enough grade for water to flow, but not enough to cause soil washing. Deepfurrow row crops



(Photo: U. S. Soil Conservation Service)

Fig. 20-5. Contour-furrow irrigation of potatoes in Idaho. Water delivered to rows by means of gated surface pipe.

can be irrigated safely by the contour-furrow method on cross slopes up to about 8 per cent in arid areas. However, this is a questionable practice in semi-arid regions.

Broad-Furrow Irrigation

On slopes not exceeding 3 per cent for most soils, the use of broad-bottom furrows in place of the usual narrow V-type furrow will increase the rate of water intake and reduce furrow erosion. This method is recommended for orchards planted on contour benches as a means of eliminating erosion resulting from grade variation along the benches.

Sprinkler Irrigation (Figs. 20-6 and 20-7)

Where it is adapted and where crop returns can support the cost, sprinkler irrigation provides excellent control of the water applied to the soil. Water may be applied with sprinklers at a rate which the soil will absorb without runoff. Sprinklers can be turned off when the soil has absorbed the right amount of water. Because the water can be so carefully controlled, sprinklers have special uses in conservation irrigation. For example, they can be used to establish pastures on steep slopes. Sprinklers, however, cannot be used universally. In hot windy climates, much water is lost through evaporation and wind drift causes uneven water application. On very heavy soils, because of the low intake ability the rate of applying water may have to be so low that much of it is evaporated before it enters the soil.

Controlled Flooding

In this method water is flooded down slope between closely spaced field ditches which keep the water from concentrating and causing erosion. Frequent openings in the ditches allow a uniform distribution of water over the field.

5. Supplying Supplemental Irrigation

Supplemental irrigation is the artificial watering of crops in regions where rainfall is ordinarily depended on for moisture. It is used to prevent retardation of growth during periods of drought. Although these periods may be of comparatively short duration, even a few days' check in the growth of plants may be of great importance in a short growing season. Farmers in the humid regions of the country are showing more and

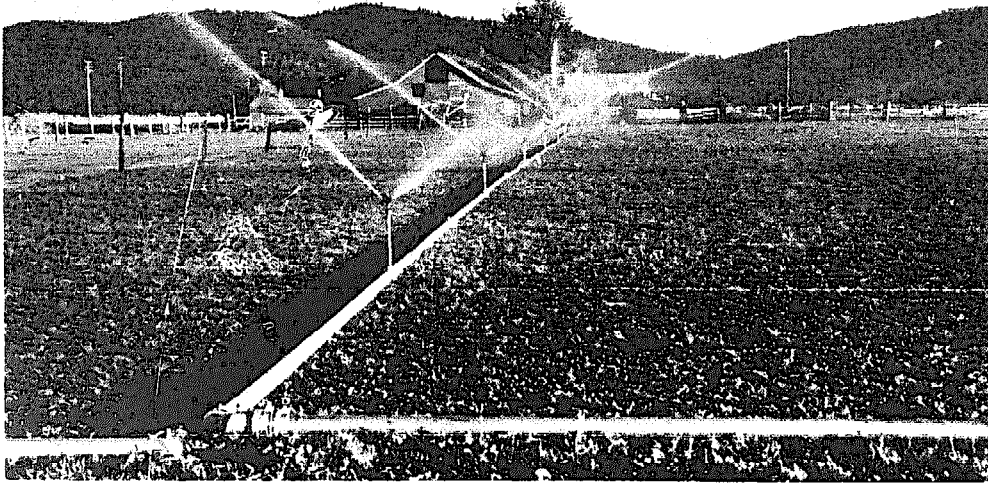

(Photo: U. S. Soil Conservation Service)

Fig. 20-6. Sprinkler irrigation in Idaho.



(Photo: U. S. Soil Conservation Service)

Fig. 20-7. Wheel-type portable sprinkler irrigation system working on pasture in Colorado.

more interest in irrigation and many irrigation systems are in use today in these regions.

Study Rainfall Pattern

A study of the rainfall pattern of the humid section gives reasons why supplemental irrigation is important. The probable average number of periods of deficient rainfall per year for several representative states are:*

State	1 to 2 weeks	2 to 3 weeks
Illinois.....	6 periods	1 period
Ohio.....	5 "	1 "
Iowa.....	8 "	1 "
Minnesota.....	6 "	2 periods

Periods of deficient rainfall refer to those periods when the rainfall is insufficient to meet the needs of the crop being grown. While various crops require different amounts of water, the average needs will approximate $\frac{1}{2}$ to 1 inch per week. Obviously, a rule so general as this cannot be used because the needs of various crops vary greatly from day to day and from place to place. The smart irrigator will design his system to meet the exact needs of the crop at the time he is irrigating. In order to do this, local information must be used.

In the humid region, studies in 18 states indicate further that once in 7 years, a period of 6 weeks occurred in which precipitation was less than one-quarter inch. Once in 2 years, a like period of 4 weeks or more occurred.

*From "Electric Power for Irrigation in the Humid Region" published by the committee on the Relationship of Electricity to Agriculture, 11017, No. 2.

Study Local Rainfall Records

For any locality, information on need for supplemental irrigation can be obtained by a study of local rainfall records for the months of May, June, July, August, and September, with special emphasis on June, July and August.

Applying water by means of supplemental irrigation has other benefits beyond the prime one of insuring the crop. Optimum moisture conditions usually insure better seed germination. Better quality crops, as well as increased yields, result from eliminating short dry periods. Frost control is another benefit for crops growing in low areas if irrigation is done by sprinkler.

Practically all the precautions against erosion and over-use of water, which apply to irrigation in the arid regions, also apply to supplemental irrigation. You should check with local conservationists regarding the latest information on irrigation in your area. Also, additional information on irrigation may be obtained from the following publications of the Department of Agriculture:

- U.S.D.A. Leaflet 342, Contour Furrow Irrigation
- “ Leaflet 297, Border Irrigation
- “ Leaflet 343, Corrugation Irrigation
- “ Leaflet 344, Furrow Irrigation
- “ Farmers' Bulletin 2059, Irrigating Corn
- “ Farmers' Bulletin 2230, Irrigated Pastures for Forage Production and Soil Conservation in the West
- “ Agriculture Handbook 107, Conservation Irrigation in Humid Areas

Chapter

XXI

USING LAND FOR RECREATION

A new conservation use for land is recreation. The demand for open space for outdoor recreation is multiplying with each passing season. Urban residents are willing to pay for the privilege of enjoying outdoor activities on private land.

Many farmers and ranchers have land that they may choose to use for some form of recreation and from which they can derive some additional income. If planned and managed properly this recreation use can be one way to provide for the conservation of the particular piece of land in question. If the land is within reach of a paying market, sale of recreation privileges may prove more profitable than producing crops such as wheat or cotton, livestock, or timber. By planning carefully it is possible to accommodate recreationists on the same land that produces some farm crops. By this multiple use you can add a new paying enterprise to your farm or ranch. Or, you may turn idle land into an entirely new business in your community.

Serving vacationers and weekend pleasure seekers, however, is for most people a new and tricky kind of business. You will want to judge your situation care-

fully—your market, your land and water resources, and your own aptitudes—before investing in a recreation enterprise for profit.

Here are some of the kinds of recreation country people are selling or renting in steadily increasing volume:

Picnic and Sports Areas

Picnic and sports areas sometimes offer good opportunities for supplemental income near large population centers. In fact, under favorable conditions, such developments may provide a full-time business.

This type of enterprise usually offers a combination of recreation facilities often for part or all of a day. You can charge for the facilities either separately or as a package on a daily fee basis.



(Photo: U. S. Soil Conservation Service)

Fig. 21-1. Entrance to a farmer-operated recreational area.



(Photo: U. S. Soil Conservation Service)

Fig. 21-2. A pond surrounded by a living fence provides fishing and a place for a picnic.

Picnic and sports areas usually should be within an hour's drive of a city or a group of towns with a population of 20,000 or more. The property needs to be on a good highway and have a safe road leading to a well-maintained parking lot.

The center of activity is usually a body of water—a pond, lake, stream, or bay. If you do not have the water, a good site for impounding it is one of the most important points to consider. The size of the water area will govern the kinds of activities and number of people you can accommodate.

Picnic areas need trees for shade. Other basic facilities for picnic areas are tables, fireplaces, shelters, toilets, garbage and refuse disposal, and water supply.

Suitable terrain for each kind of sport will be needed; for example, level ground for baseball and tennis.



(Photo: U. S. Soil Conservation Service)

Fig. 21-3. A place to pitch a tent is often a welcome sight for the family on a camping trip.

You will need an adequate source of electricity for the size of the enterprise you plan. Drinking water and sanitary waste-disposal facilities may require official approval. Your enterprise must meet requirements of state laws and regulations, including those pertaining to water rights and uses and to public health and safety. Some states require life guards for swimming areas. You will need adequate liability insurance.

To run this type of recreation operation you need to be tolerant of people and their behavior and have the ability to handle groups. You have a further advantage

if you can supervise games, coach sports, prepare barbecues, and manage other recreation activities.

Homegrown sweet corn, watermelons, poultry, and the like can be served or sold for group picnics and barbecues.

Camping

Family camping is one of the most rapidly growing outdoor activities today. Private campgrounds are proving increasingly popular, especially in areas not adequately served by public campgrounds.

Private campgrounds serve two types of clientele—travelers stopping overnight en route and vacationers, most often families, seeking a quiet place to camp for several days.



(Photo: U. S. Soil Conservation Service)

Fig. 21-4. Riding is one of the favorite outdoor pleasures where there are trails, woods, and open pastures and meadows.

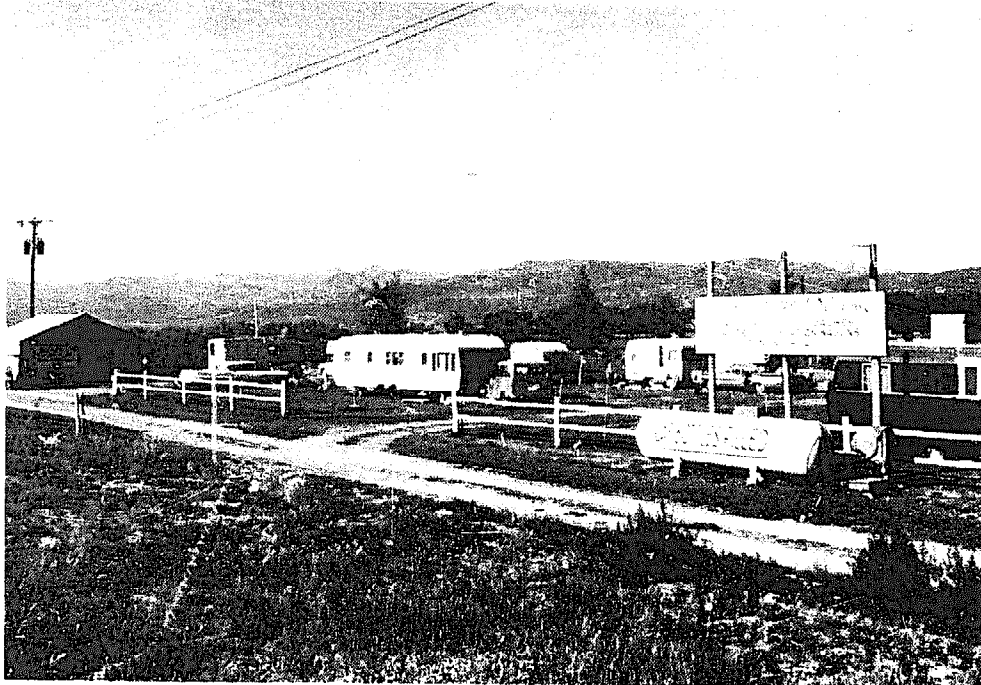

(Photo: U. S. Soil Conservation Service)

Fig. 21-5. An overnight camping area for trailers, tents, and pickups. This one is operated on the honor system where fees are deposited in a box provided for this purpose.

The main requirement for campgrounds for overnight use is a convenient location on a well-traveled tourist highway. The necessary facilities for overnight camping can be developed on almost any site of suitable terrain and soil.

Campers who are looking for a place to camp for several days are apt to be more demanding in such things as scenic and nature areas. You will need good scenery either on the property or within view of it. Special attractions on the ground or nearby help attract customers—national forests, historic sites, hiking or nature trails, bridle paths.

A campground should have trees for shade, fairly level or gently sloping ground for tent or trailer sites, soil suitable for sewage disposal, and suitable ground cover. Access to a stream, lake, or other body of water is an advantage. Facilities needed are similar to those

needed for picnic or sports areas. For overnight guests, campgrounds also need laundry rooms, showers, and electric outlets. A camp store offering groceries and supplies can bring added business.

Hunting Areas

Most farms and ranches produce game of one kind or another in amounts that offer hunting opportunities. Although the wild game on your land belongs to the state, you may charge for the privilege of entering your property to hunt. In most cases, hunting interferes little with normal farm or ranch operations. In response to a growing demand, more and more landowners are marketing hunting privileges.

If your farm or ranch has a conservation plan on it

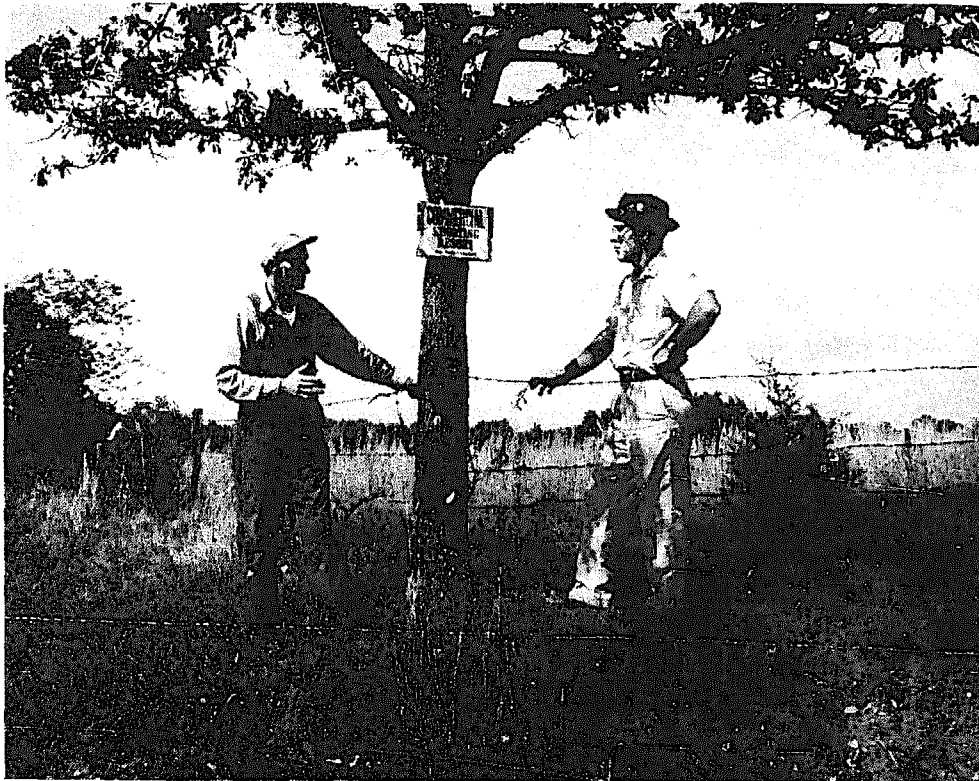

(Photo: U. S. Soil Conservation Service)

Fig. 21-6. Farmer and sportsman talk over hunting rights on a farm.

the chances are good that you will have a good variety of game birds and animals as a natural part of the wildlife population, since conservation practices such as ponds, woods, waterways, stripcropping, living fences, and wildlife plantings provide food and cover. Controlled harvesting of the surplus wildlife could be an advantage to the maintenance of a balance between the wildlife and their food supply in addition to providing some income to the owner of the land.

You can offer other services, such as board and lodging for your customers, sale of hunting supplies and equipment, and rental of vehicles and hunting dogs.

The privilege of hunting on private land can be granted in many forms. Where land holdings are small and upland game is the crop, owners can combine their properties into a single hunting area and lease it to a group of hunters. Or, they can sell permits by the day to individual hunters. The expense of such an operation is usually small and consists largely of improving the wildlife habitat to increase the game.

Operators of hunting enterprises need to have a positive interest in hunting and in the promotion of good sportsmanship. Farmer-sportsman relationship is extremely important here and can have a lot to do with the success of your enterprise. The same is true of your relationship with the state game department. Some states have cooperative systems of hunting control that favor operations of hunting areas. All states exercise control over the harvest of game through seasons and bag limits.

Shooting Preserves

A "shooting preserve" differs from a farm or ranch hunting area in that the operation depends on pen-raised game. The season for hunting on licensed preserves usually is much longer than for wild game.



(Photo: U. S. Soil Conservation Service)

Fig. 21-7. Strip of sorghum with grass strip and woods on a shooting preserve near Washington, D.C.

The shooting preserve is usually the primary business of the operator, with farming a supporting activity to raise food for the penned game and to provide cover when the birds are released. Farming also helps to use the land, equipment, and labor during the non-hunting season.

The game is usually purchased from a commercial producer, although you may find it profitable to raise your own if you have a large preserve. Hunting dogs and a handler are usually part of the service. The customer is guaranteed shooting and game to take home. Fees are often on the basis of the amount of game killed.

An essential feature of a shooting preserve is the

shooting field where the birds are released shortly before the hunt. Most preserves have several such fields.

A well-planned shooting field holds released birds within the field and gives them little chance for escape to other areas. It also provides a pleasant landscape and furnishes hunters good, safe shooting without strenuous effort.

Shooting fields can have a great variety of layouts. They usually include combinations of strips of grain with annual cover or meadow, perennial cover, and meadow borders. Continuous hedgerows allow birds to run long distances, so they should be broken at intervals and where they connect with other cover. Shooting fields include scattered weedy patches, small clumps of shrubs, and meadow plants.



(Photo: U. S. Soil Conservation Service)

Fig. 21-8. Bass and bluegill fishing in a pond on an Indiana farm.

The lay of the land affects the pattern of plant cover. On sloping land, plantings need to be made in strips across the slope. Such a pattern is needed to control erosion as well as to make walking easier for the hunter.

Fishing

Where land adjoins public water—lake, river, bay, or ocean—or has a stream running through it, access



(Photo: U. S. Soil Conservation Service)

Fig. 21-9. Fishing customers are more than willing to pay for this kind of recreation.



(Photo: U. S. Soil Conservation Service)

Fig. 21-10. This farmer collects by the honor system.

privileges can be offered for a fee. If fish are raised in private water, the fish or the privilege of catching them can be sold.

To this can be added the sale or rental of boats, motors, tackle, bait, and supplies.

In order to operate a fishing enterprise it is necessary

to know how to care for fish and manage water for good fishing. Also, friendliness and the ability to talk fishing with customers is helpful, although some small enterprises can be set up so customers deposit their fees under the "honor" system.

Most states have laws and regulations governing the production and sale of game fish in private enterprise and concerning water developments, sanitary facilities, and the like. It is a good idea to consult local authorities on all these points.

Vacation Farms and Ranches

More and more city people are discovering that they can enjoy a refreshing vacation by spending a week or more on one of the many farms and ranches that take in paying guests. The charges are moderate, as vacations go, yet they can add income to the farm or ranch business.

The appeal of "farm vacations" rests on (1) release from the confinements of city life, (2) the opportunity to return to "the great open spaces," and (3) the mystery and fascination that farming holds for most modern city-bred Americans. Ranch life has the added appeal of western atmosphere, work with horses and livestock, and "cowboy living." Dude ranches in the East, South, and Midwest create this atmosphere for their guests.

Parents especially appreciate the opportunity for their children to experience country life. Some vacation farms make special arrangements to care for school-age guests without their parents.

Operators of vacation farms and ranches ordinarily charge by the week or month for board and lodging and whatever recreation privileges they have. Major expenses are for food, supplies such as towels and bedding, utilities, and liability insurance. Part of the food

is produced on the farm. Extra labor is hired at times to help with cooking and laundry.

Farms with diversified activities seem to be best for this purpose—that is, those producing both crops and livestock, and those having both fields and woodlands. The scenery should be pleasing but need not be exceptional. A “quiet” place is more important than spectacular views, although outstanding scenic and historical features nearby help attract customers.

Many farms and ranches can be adapted to vacation use without any additional facilities. But it may be necessary to add additional sleeping quarters, sanitary facilities, and a dining area.

Good home-cooked food is a primary attraction of

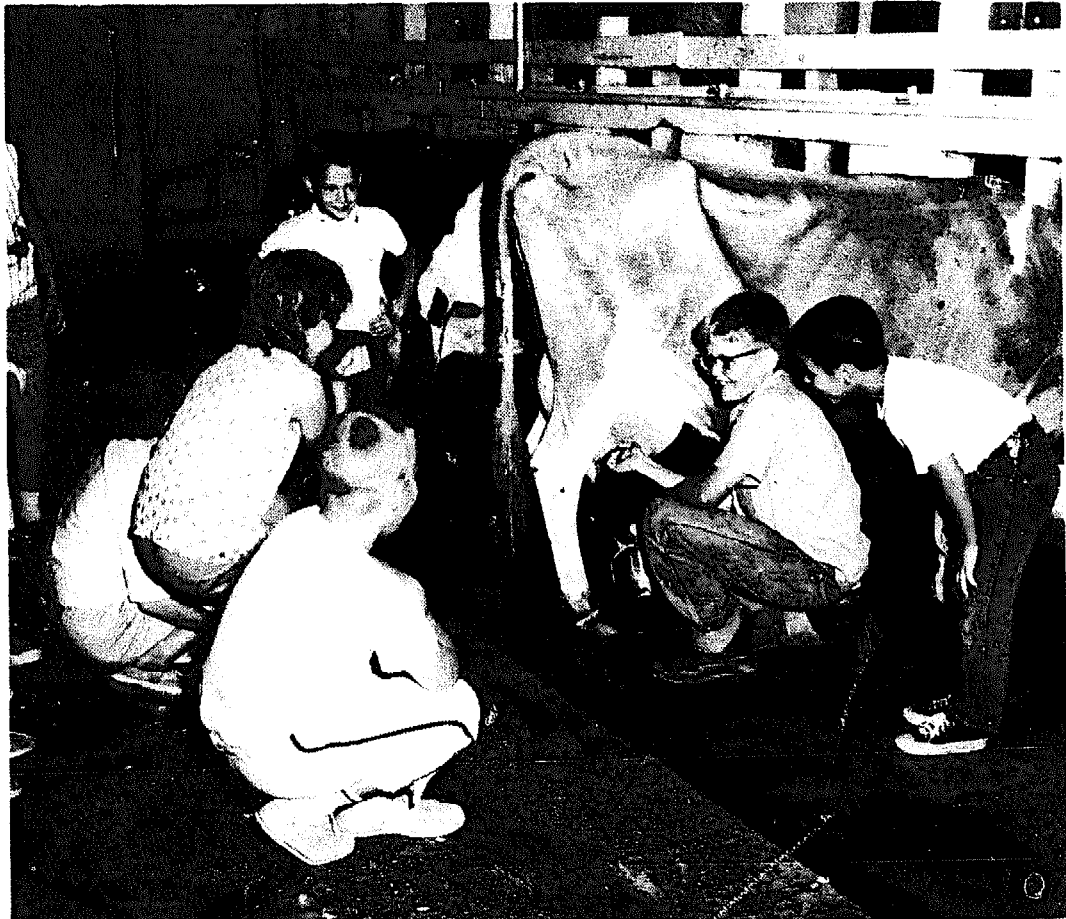

(Photo: U. S. Soil Conservation Service)

Fig. 21-11. City kids enjoy themselves on a vacation farm.



(Photos: U. S. Soil Conservation Service)

Fig. 21-12. Don't overlook the possibilities for winter sports where the natural conditions are favorable.

vacation farms. The water supply, food, and living conditions must meet the health and sanitary standards of the state and locality as well as satisfy the guests. Adequate liability insurance is essential.

You and your family must honestly like to have people around and enjoy meeting and visiting with strangers if you are to make a success of a vacation farm or ranch. You will need a knack for good conversation and the ability to plan interesting activities for your guests. You will need skill in guiding their participation in farm or ranch activities, such as milking, feeding and caring for animals, haying, fruit picking, and possibly arts and crafts.

Land

In selecting the most desirable spots for recreation areas, you need to consider related land uses on the same and adjoining land. Then, to develop adequate facilities and attractive surroundings, you will want to make the best use of your soil, water, plant, and animal resources.

Before you invest time and money in recreation developments, you need a well-thought-out plan of land use and conservation for the entire area. Rural recreation is a land use, like growing cultivated crops or grazing livestock. Its long-term success requires the same careful planning that farmers and ranchers have found necessary in using land for these more usual agricultural purposes.

In making the plan, use the soil map and land capability interpretation suggested in Chapter I. You may also need a topographic map of prospective pond sites; recommendations for planting grass, trees, or shrubs, or for managing existing stands; or information about game or fish management.

No specific rules can be laid down for interpreting

the land capability classes in terms of recreation use. The "better" land—or land that is level or nearly so, with soil that is deep and inherently productive—can be used much more heavily than steep, shallow, sandy, or otherwise unproductive land. The land with the fewest limitations can be given the heaviest work to do. In general, Class I land can be used intensively for play areas, cookout sites, campfire circles, camp craft areas, and areas around buildings—in other words, where traffic is heavy. Even Class I land will suffer, however, if abused.

Classes II and III normally can be used for these same things. However, certain conservation practices will be needed in order to overcome such hazards as erosion, fire, or wind.

Steeply sloping Class IV and VI lands have erosion hazards. Properly planned trails may be constructed for reasonably heavy use. Some outpost camps may be located there, as well as camp craft areas where children may build temporary shelters and camp furnishings.

Class V land, level but unsuited to agricultural use because of wetness or obstructions, may be given heavy use in a camp or other recreation use. For example, large stones which prohibit tilling the soil may prove no serious handicap for buildings.

In general, Class VII land should be kept in grass or trees and given very little use. Trails must be carefully constructed to prevent erosion damage—perhaps located on the edge of the area rather than in it.

Class VIII land, which has no agricultural use, might be suitable for a campsite or some other types of recreation use. A sandy beach, for example, is Class VIII land. So is a marsh. A beach is an obvious asset to a camp. The marsh may be extremely valuable for the encouragement and study of certain forms of wildlife and for nature study. However, some Class VIII

land is very steep and severely eroded, giving precarious support to only a few shrubs. It must be treated very carefully, perhaps even to the extent of keeping people off entirely.

The important point is that the conservation plan will be tailored to the condition of the site. Some cropland may be planted to trees or grass. Livestock may be fenced out of areas to be used for recreation. Crops may be planted for wildlife food. Lowlands may need to be flooded to form ponds or waterfowl areas.

You may want to make these changes immediately or you may extend them over several years. Some can be made with little or no cash outlay; others require a considerable investment. For some, you need help from professional conservationists and others.

APPENDIX

Summary of Approved Practices in Soil Conservation

CHAPTER I

Using Land Within Its Capability

1. Selecting the proper use for each kind of land, that is for crops, grass, trees, wildlife, etc., is the first step in conservation farming.
2. In order to determine the proper use of land, it is necessary to know its physical features such as depth, slope, texture, structure, and many others.
3. Some of the important land features are:
 - a. Depth of soil material.
 - b. Air and water movement in the soil.
 - c. Color of surface soil.
 - d. Texture of the surface soil.
 - e. Steepness of slope.
 - f. Degree of erosion.
4. In some parts of the country there are other features such as depth of water table, danger of overflow, and presence of alkali which are just as important as those listed above.
5. After studying and appraising the different land features, land is classified according to its capability.
6. First, all land fits into two groups: Land suited for cropland and land suited only for permanent vegetation.
7. Classes I, II, III and IV are suited for crops and

Classes V, VI, VII, and VIII are suited only for permanent vegetation.

8. Class I land is very good land for cultivation and needs only ordinary good farming methods.
9. Class II land is good for cultivation and can be farmed safely with easily applied conservation practices.
10. Class III land is fairly good land for cultivation and can be farmed safely with intensive conservation measures.
11. Class IV land is suited for only limited cultivation and must be handled with great care when cultivated.
12. Class V land is either too wet or stony or otherwise unfit for cultivation but needs only ordinary good management to be used for trees or grass.
13. Class VI land is suited for trees or grass if carefully managed.
14. Class VII land needs extreme care to be used for grass or trees.
15. Class VIII land is not suitable for cultivation, grass or trees but may be valuable for wildlife, recreation, or watershed protection.

CHAPTER II

Using Cropping Systems That Conserve Soil and Water

1. Cropping systems should maintain good soil tilth.
2. Crop rotations are one good way to maintain tilth and should contain grasses and legumes.
3. Less power is needed to work land that is in good tilth because the plow layer is lighter.
4. Crop rotations add flexibility to the conservation

- plan by making possible various combinations of practices.
5. Through crop rotations the land is kept covered a higher percentage of the time which accounts for some soil saving.
 6. New equipment and new methods have made it possible to grow the same crop year after year on the same land and still maintain tilth. This is called monoculture.
 7. On some soils monoculture is feasible. One main advantage is that crops can be grown on the soils most suitable for them.
 8. There are some problems with monoculture such as erosion danger on sloping land, nitrogen, weeds and diseases.
 9. Continuous corn may actually be safe on level, highly productive soil with proper use of fertilizers and handling of residue.
 10. The cropping system should be fitted to the kinds of soil you have.
 11. The better the soil the more choices you have for choosing a cropping system.

CHAPTER III

Engineering Instruments

1. In order to plan and establish mechanical practices it is necessary to know the differences in elevation. This requires a knowledge of some of the engineering instruments.
2. Four kinds of levels are commonly used in farm conservation work.
 - a. The engineer's wye level.
 - b. The dumpy level.
 - c. The Locke hand level.
 - d. The abney level.

3. The Locke hand level is used for rough measurements of differences in elevation. It is satisfactory for laying out contour lines, strips, and for sizing up an area for a pond.
4. The abney level is similar to the Locke hand level except that it is equipped with a graduated arc for reading per cent of slope.
5. Survey instruments are precise, delicate pieces of equipment and are expensive. Therefore they should be handled with utmost care.
6. In mounting the wye and dumpy level on the tripods, be sure that you follow the instructions of the manufacturer. Practice will enable you to get the "feel" so that you will not tighten the nuts too much.
7. Carry the instrument on the shoulder, mounted on the tripod. Don't allow the instrument to fall.
8. From the very beginning, cultivate the habit of delicate manipulation of the instrument.
9. Store engineering instruments in a dry place. Keep them clean.
10. Learn your "pace factor" by practicing pacing a measured distance, for example 500 feet. The pace factor is the distance in feet divided by the number of paces.
11. Chaining is the most common method for measuring horizontal distances with required accuracy.
12. Survey lines are measured in stations. The distance between full stations is 100 feet.
13. Dumpy and wye levels can be used to:
 - a. Measure slope in per cent by reading the difference in elevation on a slope at two points 100 feet apart.
 - b. Stake out contour lines by reading from where the level is set up along a level line.
 - c. Stake out terraces by reading from the level

along a line that is graded by adjusting the reading at each stake.

- d. Run profiles of gullies and other areas by plotting on graph paper the elevations at various points.

CHAPTER IV

Calculating Runoff from a Watershed

1. In order to design waterways, ponds, structures and other conservation practices, it is necessary to have a reasonable idea of the rate at which water runs off the area being planned.
2. The runoff rate depends on the characteristics of the watershed, such as slope, cover, kind of soil, and the nature of the rainfall of the area.
3. Rainfall frequency is based on weather records and is stated in terms of what can be expected in 10, 20 or 50 years. Hence, the term, "50-year storm" indicates what might be expected to occur once in 50 years.
4. Runoff is measured in cubic feet per second—cfs.
5. All the land in the watershed must be included in the calculations, even though it is on a neighbor's farm.
6. Runoff rates can be higher for permanent structures made of concrete, for example, than for vegetated waterways. Tables prepared for making these calculations allow for this difference.
7. Summarize the characteristics of the watershed, as explained on page 61, and from the table calculate the runoff rate in cubic feet per second. This figure is then used in designing the conservation practice in question, such as waterway, pond, etc.

started. This may be done by plowing temporary channels along the sides.

14. Use manure and fertilizer occasionally to keep the grass strong.
15. Repair the sod when necessary. It is easier to do when a break is small than after a large gully has started.
16. Always lift plows and straighten disks when crossing waterways and use care in pasturing them.

CHAPTER VI

Farming on the Contour

1. In contour farming all planting or farming operations are laid out from a guide line that runs across the field approximately level.
2. Two men can lay out contour guide lines, one man using a level and the other man being a target and setting stakes.
3. A field may need more than one guide line if it has a long slope or if the slope changes.
4. The usual practice in locating the first guide line is to go to the highest point in the field and walk straight down the general slope for a distance of 80 to 150 feet, depending on the steepness of the slope.
5. After the line is located, the level man sights on the helper and motions him up or down hill until he is on the same level. Stakes set across the field following this procedure make a contour line.
6. Keep sights short when using hand levels.
7. Mark the line with a plow after it is staked.
8. Plow on the contour by backfarrowing at the guide lines and work around them. Leave unplowed strips even in width between the guide lines to be plowed last.

9. Planting on the contour follows the same general plan. Plant up and down from the guide lines, leaving an even width strip to be planted out later.

CHAPTER VII

Contour Fences

1. Contour fences may be used to separate land that is in different uses such as pasture from crops.
2. Contour fences may be of living plants or of posts and wire.
3. They may serve as guide lines for planting crops on the contour.
4. The fence should be laid out in a smooth curve.
5. Posts should be spaced according to the sharpness of the curve, as shown in the table on page 103.
6. Line posts need to be set deep enough to withstand winter heaving.
7. In addition to the regular braces at the ends, interior braces are needed on the curves.
8. Place the wire on the outside of the posts on curves.
9. Stretch wire in short sections to prevent it from hanging to posts on curves.

CHAPTER VIII

Strip Crop Farming

1. The four kinds of strip cropping are (1) contour strip cropping, (2) field strip cropping, (3) wind strip cropping, and (4) buffer strip cropping.
2. In contour strip cropping the crops are arranged in strips on the contour.
3. In field strip cropping the strips are of uniform

- width and are across the slope but not necessarily on the contour.
4. In wind strip cropping the strips are uniform in width and are laid out across the direction of prevailing wind.
 5. With buffer strip cropping, strips of grass take up the uneven space between even width cultivated strips.
 6. Contour strip cropping can be laid out (1) with both edges of the strips on the contour, (2) with one or more even-width strips laid out from a key or base contour line, or (3) with alternate even and irregular width strips.
 7. With the first method all strips are irregular in width because a perfectly uniform slope is rarely found.
 8. Many farmers prefer the second method where several strips of even width are laid out from a key contour line. The strips are more convenient to farm. However, all farming operations are not on the true contour.
 9. Different methods may be used to lay out this type of strip cropping but the basic problem is to find the right location for the key contour line. Experience will help you to learn where the predominant slope condition is and, therefore, where to lay out the key line.
 10. Width of strips depends on the steepness and length of slope. Usually the width varies from 60 to 150 feet.
 11. After strips are laid out they should be farmed in a crop rotation that suits the capability of the land.
 12. By arranging the crops within the strip cropping system, you can have crop balance, convenience of farming, and insect control.

13. Strip-cropped fields have been found to have larger breeding populations of ground-nesting birds than comparable fields not strip-cropped.

CHAPTER IX

Laying Out and Constructing Terraces and Diversions

1. Terraces break up a slope into many short slopes and carry water across the field to a protected outlet or other area.
2. Terraces may be needed on cropland that slopes as much as two per cent and where the slope is longer than 300 to 400 feet, depending on local conditions.
3. Terraces must be built right and maintained properly to be successful.
4. Location of the outlets is an important consideration in planning a terrace system. If natural outlets are not available, outlets will need to be built.
5. Water from the neighbor's field must be considered in planning terraces.
6. Don't build terraces too long—probably not over 1600 feet at the most. Much shorter terraces are better.
7. Terraces must be laid out with accurate instruments such as the dumpy or wye level.
8. The vertical distance between terraces must be determined. A good rule is to determine the slope and apply the formula: $\frac{\text{per cent of slope}}{2} + 2$. This formula works well in the Corn Belt. Check locally for the formula to use.
9. Stake the upper terrace first. Start at the outlet and work back toward the upper end of graded terraces. Set stakes every 50 feet and read the rod

- each time to give the grade you want in each terrace.
10. Keep a record of the terraces laid out so that you can check for proper construction.
 11. You can build terraces with many kinds of equipment. Farm plows, graders, bulldozers, etc.
 12. Terraces built from the upper side have more capacity for the amount of earth moved than if the earth is moved from both sides.
 13. After the terraces are finished, check them with rod and level to locate high and low places.
 14. You can maintain terraces by proper farming methods and by inspecting them after storms.
 15. The best way to plow terraces is with the two-way plow, a plow that has two sets of moldboards and permits throwing the soil either to the right or to the left. The two-way plow makes it possible to throw furrows up hill from the terrace channel. Thus you avoid the tendency to create a benched effect between terraces as is done with the conventional plow.
 16. There are two methods of plowing terraced land with the conventional plow, leaving the dead furrow in the terrace channel or leaving it between the terraces.
 17. All cutting tools such as disks, field cultivators, or springtooth harrows should be operated on the contour parallel to the terraces.
 18. There are several ways to plant row crops on terraced land. In all of them the terrace is used as a guide and point rows are left between the terraces. Study the drawings in Chapter IX.
 19. Harvest row crops in reverse of the way the field is planted.
 20. Many fields can be laid out so that the terraces are parallel which eliminates point rows.

21. Usually parallel systems include two or more groups of parallel terraces with the odd shaped areas between sets of terraces.
22. First stake a key line, then lay out parallel lines above and below this line until it is necessary to stake another key line. Repeat as before.
23. The grade along a parallel terrace may vary in order to keep the lines parallel. Some cutting and filling along the terrace line may also be necessary in some cases.
24. All draws will be used as waterways in a parallel system.
25. Underground outlets help make parallel terraces easier to align, and eliminate need for some waterways.
26. On steep land, grass on the backslope of terraces makes farming safer and reduces slope between terraces.
27. A diversion is an individually designed channel constructed across a slope for the purpose of intercepting surface runoff and conducting it to a safe outlet. It may divert water from the head of a gully.
28. Diversions should be kept in grass and not farmed over like terraces.
29. Diversions should ordinarily be designed so that the velocity of the flow will be as high as possible and still not damage the vegetation in the channel.
30. Diversions can be constructed similar to the way terraces are.
31. Keep vegetation strong in the diversion unless it was designed for bare channel conditions.
32. Remove silt accumulations if they occur and repair rodent damage.

CHAPTER X

Minimum Tillage

1. Excessive tillage causes soil erosion, compaction, and loss of moisture.
2. New equipment and new methods are making it possible to reduce the number of trips over a field.
3. Mulch planting is the planting of row crops directly in cover crops, in sod, or in crop residue with little or no preparation.
4. Mulch planting saves time, labor, soil and moisture, and supplements some conservation practices such as strip cropping and terracing.
5. Mulch tillage is not well adapted to slowly drained soils.
6. Additional nitrogen will be needed.
7. Mulch tillage is most suited to sandy and sandy loam soils but can be used on nearly all soils if proper equipment is used.
8. Best yields cannot be expected if corn or beans are planted directly in sod in the northern part of the Corn Belt.
9. Latest methods consist of slot planting, strip tillage, no-till, till planting, and chisel planting.
10. All minimum tillage operations should be done on the contour.
11. On irregular land with four-row or bigger equipment, individual units should be on flexible mounts.
12. Plow-planting is planting row crops right after plowing.
13. Good residue management is essential to a conservation farming program. All handling of residues is done so as to leave residues of the previous crop on top of the soil until the next crop is seeded.
14. This is called stubble mulching in the Great Plains

- and is especially important there where wind erosion control and moisture conservation are needed.
15. Sweep-type implements work beneath the residues and loosen the soil, thereby killing weeds. Use wide sweeps—30 inches or wider.

CHAPTER XI

Laying Out and Constructing Ponds

1. Build ponds plenty big to take care of livestock water, and other uses. Allow for evaporation and seepage and for long dry spells.
2. The pond should be built on a site that will hold water. Avoid sand, rock outcroppings, gravel, peat or marl.
3. The watershed above the pond should be large enough to provide plenty of runoff for the pond but not so large as to require a large and expensive outlet structure.
4. The watershed should be protected by vegetation so that the pond will not fill with silt.
5. Make a survey of the pond site and the gully below it. Study the gully to see if it is active.
6. Make a simple grid on which to plot the pond. This will show how large the surface area will be and will help you to estimate the amount of earth to be moved.
7. Lay out the pond from a base line using the rule of 3, 4 and 5 to get right angles. From this base line plot the pond by staking the water line and the fill.
8. Pond fills should have a slope of 3 to 1 on the up-stream side and not steeper than 2 to 1 on the down-stream side on most soils.
9. A mechanical spillway is desirable on ponds with

considerable drainage area. A vegetative spillway is also necessary to handle water after the flow rises above the mechanical spillway.

10. Install the pipe spillway before starting to build the fill. Its size depends on the area of the watershed and other factors.
11. Lay the pipe in a concrete cradle between the inlet and the outlet structures. Use concrete anti-seep collars to prevent seepage along the pipe.
12. The outlet structure can be protected against erosion by extending it several feet beyond the toe of the fill. A metal pipe will serve the purpose.
13. Before building the fill lay a water pipe to carry water from the pond to a tank below the fill.
14. Prepare the pond site by removing all trees, stumps, brush, etc.
15. Make a core wall by digging a trench the length of the fill down to an impervious layer, backfilling it with impervious material.
16. Construct the fill in layers, making each layer the full length and width of the fill and pack each one with the equipment.
17. The weight of the fill material will cause settlement so you will need to allow for it by adding a little height.
18. As soon as the fill is finished it should be seeded to prevent erosion.
19. An excavated pond is dug out of nearly level land.
20. Excavated ponds are usually built rectangular in shape.
21. The best method of sealing a pond is by compaction at time of construction.
22. A clay blanket may be used to cover the pond area if it consists of high percentage of coarse material.
23. Bentonite, mixed with the soil, will seal some ponds.

24. Sodium polyphosphate, common salt, and soda ash are dispersing agents and can be used to seal ponds.
25. Waterproof linings are also used.

CHAPTER XII

Preventing and Healing Gullies

1. The best way to control gullies is to prevent their formation.
2. The simplest and cheapest way to control small gullies is to fence them and exclude livestock.
3. In many cases it will be necessary to divert water from the gully with a diversion terrace.
4. Many gullies can be bladed in, shaped, and seeded to form grassed waterways.
5. Some gullies are so large and unstable that structures are needed to control them.
6. Temporary structures made of brush, logs, and wire are not recommended.
7. Permanent structures are made of reinforced concrete, masonry, or earth with concrete or steel pipe spillways.
8. The drop inlet is ideally suited for controlling gully heads in gullies more than 10 feet deep.
9. An emergency spillway around one end of the dam is necessary to protect it during severe storms.
10. Drop spillways are used in dry draws not subject to continuous flow and are suited to gullies where water will be dropped not more than 10 feet.
11. Box inlet drop spillways are used in narrow channels.
12. Chutes are used in combination with earth dams where it is necessary to drop water farther than feasible with drop structures.

CHAPTER XIII

Controlling Erosion on Construction Sites

1. Erosion-control methods used on farmland can also be used to control erosion which is a serious hazard on much urban construction.
2. Mechanical measures consist of land grading, diversions, berms, outlets, waterway stabilization structures, lined channels, sediment basins and stream channel and bank stabilization.
3. Land grading should be kept to a minimum and should be done just ahead of construction to avoid exposure of the site to erosion.
4. Diversions and berms, both permanent and temporary, protect newly constructed slopes until permanent protection is provided.
5. Outlets are necessary to carry off surplus water but must be protected from erosion.
6. Structures and lined channels are needed where vegetation alone will not do the job.
7. A sediment basin holds runoff water and allows sediment to settle out, preventing damage downstream.
8. Vegetative measures can provide temporary protection during construction, and permanent cover after construction is completed.
9. Mulches are excellent for protecting slopes before seeding and help get grass started. Straw, hay, and artificial materials are used.
10. Temporary cover crops are used where cover is needed for a short time.
11. Critical areas need special care, including anchoring mulch, special nettings of jute or plastic, emulsified asphalt, and in some cases sodding.

CHAPTER XIV

Controlling Sandblows

1. Bare sand is not only unproductive—it may do great damage by covering cropland, pasture and forest or by filling drainage ditches and blocking roads.
2. Trees planted in open sand have little chance for survival.
3. Planting beachgrass is the cheapest and most effective method of sandblow stabilization.
4. Since beachgrass does not produce seed readily, it must be planted by selecting plants from existing grass stands.
5. Plant it in clumps. By spacing the clumps closely immediate stabilization can be achieved. On large sandblows, scattered or “skeleton” planting reduces the cost but requires more time for complete control.
6. Plant trees after the beachgrass has stopped sand movement but before growth is too thick.
7. Brush may be used on small sandblows or where beachgrass is not available. Also, cornstalks, straw, gravel and other materials may be used.

CHAPTER XV

Planting Shelterbelts

1. Shelterbelts are planted for the purpose of protecting fields from destructive wind damage, as compared to windbreaks which serve to protect the farmstead.
2. Shelterbelts control soil blowing and protect crops.
3. The techniques involved in planting trees for windbreaks and shelterbelts are not radically different

than for other kinds of field planting. However, species, size of stock, ground preparation, and spacing are somewhat different.

4. Conifers, because they give year-round protection, are used more widely than hardwoods and in larger sizes than in field planting. However, many hardwood species are used in shelterbelts.
5. Check local recommendations for the kind of trees to use in your area.

CHAPTER XVI

Managing Farm Woodlands

1. Tree products are an important crop. Well managed woods will protect from erosion land that is best suited to growing trees.
2. Improving existing woods is an important part of woodland work.
3. One way of improving the woods is by thinning, giving small trees sufficient growing space.
4. Pruning will also help to increase the future value of standing trees. Pruning removes side branches so that wood subsequently formed will be free of knots.
5. In addition to thinning and pruning, the removal of vines will also improve the farm woods.
6. Planting will help Nature to restore a complete stand where there are bare areas. Plant trees on land that has little or no other use; on land that has been cut up by erosion; in understocked forests; where undesirable trees have taken over and can be removed; and on worn out, rocky, hilly land.
7. To determine what kinds of trees to plant, look around to see what kinds grow best. Also check with local foresters.

8. Forest trees should be planted when the stock is dormant and early enough to insure root establishment before dry weather.
9. In handling planting stock, keep the roots moist at all times; heel the trees in as soon as they are received from the nursery.
10. Never plant trees in unprepared ground if there is appreciable ground cover. The competing vegetation is cause for failure.
11. Set the trees in holes no deeper than they were at the nursery and thoroughly tamp the loose soil around the roots.
12. Cultivate the young trees the first summer to keep down weeds and other growth if necessary.
13. Protect the planting from grazing by domestic animals and from uncontrolled burning.
14. Measure the amount of standing timber in your woods by use of a cruiser stick that you can make in the farm shop. It is helpful to be able to estimate the amount of lumber or other product a tree or area of timber will produce.

CHAPTER XVII

Managing Land for Wildlife

1. Wildlife needs food, cover and water. A well planned and managed conservation program for the farm provides these and usually the result is a better balanced wildlife community which benefits the farm.
2. Cropland practices that help wildlife include crop rotations, liming and fertilizing, strip cropping, cover crops, stubble-mulch tillage, waterways, field borders, and many others.
3. Pasture management practices that help wildlife

- include controlled grazing, liming and fertilizing, and renovating.
4. Woodland management practices that help wildlife include protection from fire and grazing, selective cutting, leaving den trees, piling brush near edge of woods, leaving fallen hollow logs and clear-cutting of small areas in large woods.
 5. Drainage ditches are good places for wildlife if protected by healthy grass and legumes.
 6. Fence rows and hedges kept shrubby are better for wildlife than clean fence rows.
 7. Marshes can be managed to increase their wildlife population. Such marshes can add to the farm income by producing furs.
 8. Many odd areas such as gullies, bare knobs, sink holes, rocky outcrops, and other such areas can be developed for wildlife.
 9. Ponds are excellent wildlife areas if fenced and planted to proper plants. When stocked and fertilized, ponds produce fish in adequate quantities.
 10. Wildlife borders or headlands are strips of grass or other vegetation around fields. They control erosion and provide wildlife cover and food.
 11. Protect streambanks to control bank cutting, protect adjoining property, and reduce the silt in streams. This improves wildlife.

CHAPTER XVIII

Improving and Managing Pastures and Ranges

1. Good pastures help make a conservation program work.
2. Many pastures need improving. Pasture renovation includes the following steps:
 - a. Testing and treating the soil.

- b. Tearing up the old sod and preparing a seedbed for the new seeding.
 - c. Seeding a desirable mixture of grass and legumes.
 - d. Good management of the pasture after it gets started. This includes controlled grazing to avoid overgrazing.
 - e. Clipping weeds to keep them under control so that the grass can produce its maximum.
3. Range conservation includes four principles:
 - a. Adjusting numbers of livestock to available forage supply.
 - b. Adjusting the grazing by seasons between units or pastures.
 - c. Locating fences, water and salt so as to insure even grazing.
 - d. Keeping the kind of stock that will graze most economically the kind of forage on the ranch.
 4. To make a good range plan you need to take an inventory of the range. This should include the location, area and condition of the range, number and kind of livestock and other pertinent facts.
 5. The condition of the range is determined by the relative amounts of climax vegetation for each site that it is still supporting.
 6. The inventory will give information on how much forage is available in terms of livestock needs and by seasons.
 7. The map can show the boundaries of each condition, class, or site.
 8. The range plan should include conservation practices for each unit or pasture.
 9. It should include a system of grazing designed to improve the yield of depleted lands and maintain yields from the good ones.
 10. Planning is progressive. Make the plan so that it

permits its application in keeping with the resources of the operator.

CHAPTER XIX

Laying Out and Constructing Farm Drainage

1. Drainage helps many soils by removing excess water which keeps the soil cold and hard to work, and limits the root zone. By draining wet, level areas, some upland fields can be kept in grass. This is good conservation.
2. Drainage may be done either by surface drainage (open ditches) or by underdrainage (tile).
3. Plan your drainage system carefully by studying the kind of soil, making a map of the area to be drained, providing a good outlet, and planning good management of the fields drained so that the drainage system will not clog with silt.
4. Open ditches remove surface water but are not too effective in draining the soil. There are several systems of open ditch drainage.
 - a. Random ditch system where ditches are built only where there are depressions and no regular pattern is followed.
 - b. Cross slope ditch system used on gently sloping wet fields where internal drainage is poor.
 - c. Parallel ditch system on flat, poorly drained soils in which there are numerous small depressions.
 - d. Field ditch system used to lower the water table but where tile cannot be used.
 - e. Bedding, consisting of alternate dead furrows and back furrows spaced according to the kind of soil.
5. Large ditches can be made with gently sloping sides so that they can be crossed with farm ma-

- chinery although they may not be farmed over.
6. The berm is a strip of ground between the edge of the ditch and the nearer edge of the waste or spoil bank.
 7. In making large ditches, spoil banks should be kept back from the bank to prevent its sliding into the ditch.
 8. Provide some means for letting water down into the large ditches from the field ditch without erosion. Sod flumes or structures may be necessary.
 9. Field ditches should have very gentle side slopes so they can be farmed over. Spoil banks should be spread over the field.
 10. The double or "W" ditch permits surface water to enter the ditch from both sides without the need for spreading the spoil.
 11. In staking out ditches, first set stakes along the centerline and then set grade stakes to one side of the ditch.
 12. Use a gage stick to check the proper depth of the ditch during construction.
 13. Keep ditches and outlets open so that the drainage system can work. Erosion control on the watershed and grass on the ditch banks will help.
 14. The grass on the ditch banks can be mowed, sprayed, or, under some conditions, grazed.
 15. Smoothing the surface of the land will improve many drainage systems.
 16. Underdrains (tile) drain the soil rather than the surface. They do not use field space as do open ditches. But they do not carry off surface water during storms.
 17. As with surface drainage, a complete survey of the field is needed before a tile system.
 18. A tile system of short mains with long laterals is most economical.

19. Provide some means of protecting the outlet against washing the ditch bank, and to keep out small animals.
20. The size of tile for mains and laterals depends on the size of area to be drained, the grade, whether surface inlets are used, and the kind of soil. In tight soils they must be closer than in coarse textured soils.
21. Use tile that meets the specifications of the American Society for Testing Materials.
22. Stake out tile lines by setting stakes every 50 feet, with a hub stake and a grade stake at each point.
23. Trenches may be dug with machinery or by hand. Correct grade can be maintained in machine digging by using targets and a sight bar on the machine. With hand digging, use a line stretched across cross bars and a gage stick.
24. Start digging the trench at the outlet and proceed upgrade.
25. Lay tiles so that they fit close together. On curves cover the outer sides with pieces of broken tiles.
26. Blind the tile as soon as laid by covering with topsoil to hold it in place and to permit water to enter freely.
27. Make a map of the tiled field for future reference.

CHAPTER XX

Conservation Irrigation

1. Soil erosion is as great a menace to irrigated land in the arid regions as it is to land in the humid regions.
2. Uncontrolled irrigation water also causes serious drainage problems and salt accumulation on much land.

3. Much damage to irrigated land is due to irrigation runs that are too long.
4. Delivery of irrigation water in open ditches contributes heavily to water loss.
5. Abuse of the land in the watersheds that produce irrigation water has caused silting in reservoirs and canals.
6. The irrigator can solve most of his problems because he has control over the water from the time it enters the ditches. He can apply it in the right way to prevent much trouble.
7. Conservation irrigation on the farm is simply the use of irrigation and cropping methods that best fit the particular soil, slope, crop, and water supply.
8. To irrigate properly you need to know the water holding capacity of the soil, how fast the soil will take water, how deep to irrigate, and how fast the plant uses water.
9. To establish conservation irrigation on the farm
 - a. Get an inventory of the soil and water resources.
 - b. Decide how to apply the water.
 - c. Plan the distribution system.
 - d. Prepare the land so that water can be applied efficiently.
 - e. Adjust the size of water streams so that they will not cause erosion but will apply enough water to satisfy crop demands.
10. There are different methods of irrigating water to fit your land, crops, and water supply.
 - a. Basin irrigation where diked areas are filled with water to the desired depth quickly.
 - b. Border irrigation, a method of advancing a sheet of water down a narrow strip between low ridges.
 - c. Contour or bench border irrigation, where the

strips are laid out across the slope on a controlled grade and the ridges are constructed parallel to each other.

- d. Corrugation irrigation — the application of water in small furrows.
- e. Furrow irrigation — applying water in furrows between the plant rows.
- f. Contour-furrow irrigation — applying water in furrows across rather than down the slope.
- g. Broad-furrow irrigation — the use of broad furrows for orchards planted on contour benches.
- h. Sprinkler irrigation.
 - i. Controlled flooding — moving the water down slope between closely spaced field ditches to keep the water from concentrating and causing erosion.
11. Supplemental irrigation is the watering of crops in regions where rainfall is ordinarily depended on for moisture. It has many benefits beyond the prime one of insuring the crop.
12. Practically all the precautions against erosion and over-use of water, which apply to irrigation in the arid regions, also apply to supplemental irrigation.

CHAPTER XXI

Using Land for Recreation

1. Recreation is a new land use for farm land. It is helping fill a growing need.
2. Picnic and sports areas within an hour's drive of a population center are popular. A pond, lake or stream provides a setting.
3. Family camping can easily be provided on many farms. It is increasing in demand. Campsites should be near a highway.

4. Hunting areas offer possibilities for farmers who can manage game and are willing to provide shooting for hunters.
5. Shooting preserves require ability to produce and handle pen-raised game. A shooting preserve is usually the primary business of the operator.
6. Fishing, along with sale or rental of boats, motors, tackle, bait, and supplies can be a profitable enterprise.
7. Some farmers and their families are suited to operating vacation farms for city people who want to get away from crowded conditions and especially those who want their children to have a farm experience.
8. The capability of the land to endure heavy traffic must be considered, in deciding the kind of recreation enterprise to have.

GLOSSARY

Soil and Water Conservation Terms

(By permission of the Soil Conservation Society of America)

Accelerated Erosion—Erosion of soil material at a rate greater than that of normal erosion. Erosion more rapid than that which existed under natural conditions. Accelerated erosion occurs as a result of destruction of vegetal cover or of some activity of man. It may consist of any of the recognized types of erosion such as sheet erosion, rill erosion, gully erosion, wind erosion, or landslides, or combinations of them.

Acid Soil—A “sour” soil, containing more hydrogen than hydroxyl ions. Precisely, a soil with a pH of less than 7.0. For practical purposes, a soil with a pH below 6.6. See pH.

Alkali Soil—A soil that has so high a degree of alkalinity, or so high a percentage of exchangeable sodium, or both, that the growth of most crop plants is reduced. This is true if the pH is 8.5 or higher, or if the percentage of exchangeable sodium is 15 per cent or more. The soil is highly dispersed so that air and water movement is very slow. In popular usage, saline soils have often been called “white alkali.” True alkali soils, because of dispersion of the organic matter, have been called “black alkali.”

Alluvial Soil—Soil developed from transported and relatively recently deposited material (alluvium)

characterized by little or no modification of the original material by soil-forming processes.

Backfire—In forestry, a fire started intentionally ahead of an advancing fire to remove inflammable material by controlled burning and thus stop or control the main fire.

Bedding, Land—Plowing, grading or otherwise elevating the surface of fields into a series of parallel beds or "lands" with shallow surface drains separating them.

Bench Mark—A point of reference in elevation surveys.

Bench Terrace—A shelf-like embankment of earth with a level or nearly level top and a steep or vertical downhill face, constructed along the contour of sloping land to control run-off and erosion. Types of the bench terrace are the horizontal bench terrace, which has no measurable slope from the back to the front of the bench, and the sloping bench terrace, which has a significant slope from the back to the front of the bench. Contrast with Ridge Terrace.

Blowout (Erosion)—An excavation in areas of loose soil, usually sand, produced by wind action.

Border Irrigation—An open field method of flood irrigation between border dikes.

Broad-base Terrace—A ridge type terrace 10 to 20 inches high, and 15 to 30 feet wide with gently sloping sides, a rounded crown, and a dish shaped channel along the upper side, constructed to control erosion by diverting run-off along the contour at a non-scouring velocity. It may be level or have a grade toward one or both ends. See Ridge Terrace.

Buffer Strips—Contour strips of grass or other erosion-resisting vegetation between or below cultivated strips or fields.

Capillary Water (Soils)—The portion of soil water

which is held by cohesion as a continuous film around the particles and in the capillary spaces. Most of this water is available to plants.

Carrying Capacity (Wildlife)—The maximum number of a given wildlife species which any given territory will support through the most critical period of the year.

Catch Crop—A crop produced incidental to the main crop of the farm and usually occupying the land for a short period; also a crop grown to replace a main crop which has failed.

Check Dam—A small, low dam constructed in a gully or other watercourse to decrease the velocity of stream flow, for minimizing channel scour and promoting the deposition of eroded material. Usually built of inexpensive and temporary materials where dependence for ultimate protection is placed on vegetative cover.

Clay—(1) Small mineral particles of the soil, less than 0.002 mm in diameter. (2) Soil material containing 40% or more clay, less than 45% sand, and less than 40% silt.

Claypan—A horizon of accumulation or a stratum of dense compact and relatively impervious clay. Claypan is not cemented, but is hard when dry, and plastic or stiff when wet. Its presence, like that of a true hardpan, may interfere with water movement or root development.

Clean Tillage—Cultivation to prevent the growth of all vegetation except the particular crop desired.

Colluvial Soil Material—Soil material which has moved downhill and has accumulated on lower slopes and at the bottom of the hill. Colluvial material is moved downhill by the force of gravity and to some extent by soil creep, frost action and local wash. Syn. Colluvium.

Companion Crop—A crop which is grown with an-

other crop. Usually applied to a small grain crop with which forage crops are sown. The small grain crop may also be known as "nurse crop," but companion crop is the term preferred by agronomists. It may also apply to other crops such as corn and soybeans when grown together.

Compost—A pile of decomposing organic matter of plant or animal origin. Soil and other amendments such as lime, nitrogen and phosphorus may be mixed with the organic matter.

Conifer—A plant of the pine family, *Pinaceae*; examples, pines, spruces, firs, hemlocks, cedars, cypresses, or of the yew family, *Taxaceae*; examples, yew and juniper. Mostly cone-bearing and evergreen, although yew and the junipers have berry-like fruits and the larches are deciduous. Frequently referred to as softwoods, as contrasted with the broad-leaved hardwoods.

Contour—(1) An imaginary line on the surface of the earth connecting points of the same elevation. (2) A line drawn on a map to show the location of points of the same elevation. A series of contour lines on a map shows the topography of the land.

Contour Farming—Conducting field operations, such as plowing, planting, cultivating and harvesting on the contour or at right angles to the natural direction of slope.

Contour Furrows—Furrows plowed on the contour on pasture or range land to prevent soil loss and allow water to penetrate the soil. Sometimes used in planting trees or shrubs on the contour.

Contour Interval—The vertical distance between contour lines.

Contour Strip Cropping—The production of crops in comparatively narrow strips planted on the contour and at right angles to the natural direction of slope. Usually strips of grass or close growing

crops are alternated with those in cultivated crops. Graded Strip Cropping is a form of contour strip cropping in which the strips have a grade of not more than 1% laid out from a guide line in the center of the strip. All rows and furrows are continuous to a grassed waterway. Graded Strip Cropping is used on sloping land which is slightly or moderately wet. It serves to control erosion and also provides drainage by allowing surface water to follow the rows at a safe velocity.

Core Wall—A wall of masonry, sheet piling, or puddled clay built inside a dam or embankment to reduce percolation.

Correction Strip—An irregular strip or area of land lying between contour strips.

Cover, Ground—Any vegetation producing a protecting mat on or just above the soil surface. In forestry, low-growing shrubs and herbaceous plants under the trees.

Cover Crop—A close-growing crop grown primarily for the purpose of protecting and improving soil between periods of regular crop production, or between trees and vines in orchards and vineyards.

Creep, Soil—Downhill mass movement of soil or the products of weathering at an imperceptible rate, due primarily to gravity.

Crop Residue—The portion of a plant, or crop, left in the field after harvest.

Crop Rotation—The growing of different crops in recurring succession on the same land.

Cruise—A survey of forest lands to locate and estimate the volume and grades of standing timber. Also, the estimate obtained in such a survey.

Deposition—The accumulation of soil material dropped because of slackening movement of the transporting agent—water or wind. Accumulation at the

foot of an eroded slope, alluvial fans and dunes are examples of deposition.

Detention Dam—A dam constructed for the purpose of temporary storage of streamflow, or surface runoff, and for releasing the stored water at controlled rates.

Diameter Breast High—The diameter of a tree 4.5 feet above average ground level. Abbr. d.b.h.

Dike—An embankment to confine or control water, especially one built along the banks of a river to prevent overflow of lowlands; a levee.

Dispersion, Soil—The breaking down of soil aggregates, resulting in single grain structure. Ease of dispersion is an important factor influencing the erodibility of soils. Generally speaking, the more easily dispersed the soil, the more erodible it is.

Diversion—A diversion is a channel with a supporting ridge on the lower side constructed across the slope to intercept runoff and minimize erosion, or to prevent excess runoff from flowing onto lower lying areas. In some areas a series of diversions are constructed across the slope similar to terraces, but with greater horizontal and vertical spacing. Also known as Diversion Terrace.

Drain—A buried pipe or other conduit (closed drain) or a ditch (open drain) for carrying off surplus surface or ground water.

Drainage—(1) The removal of excess surface or ground water from land by means of surface or sub-surface drains. (2) The effect of soil characteristics which regulate the ease or rate of natural drainage. Soil is said to be “poorly drained” when the excess water drains away so slowly that it interferes seriously with tillage or plant growth.

Drainage Basin—The largest natural drainage area subdivision of a continent. The United States has been divided at one time or another for various ad-

ministrative purposes into some 12 to 18 drainage basins or groups of watersheds, such as the Colorado, Missouri, and Columbia basins. See Watershed.

Drainage Terrace—A graded terrace built with a relatively deep channel and low ridge primarily for hillside drainage. See Graded Terrace; Nichols Terrace.

Draw (Topography)—A natural depression or swale; a small natural drainageway.

Drift (Geology)—Material of any sort deposited in one place after having been moved from another. The term is most commonly used when referring to glacial drift, or material deposited after having been moved by glacial action. Glacial drift includes unstratified glacial deposits, or till, and stratified glacial outwash materials.

Drop Structure—A dam constructed in a gully or other watercourse to lower the grade of the watercourse and thereby decrease the velocity of flow, promote the deposition of sediment, and prevent further channel erosion.

Drop-inlet Dam—A dam with provision for carrying off overflow through a gently sloping pipe under the dam, connected to an open-topped vertical pipe, or riser, at the pond side of the dam. The length of the vertical riser or "drop inlet" is most often 5 to 15 feet, but may be more.

Dry Farming—(1) Farming in semi-arid or arid regions without irrigation. (2) A system of fallow and stubble mulch designed to absorb and retain the precipitation which occurs.

Duff—The more or less firm organic layer in forests. It consists of fallen vegetative matter in the process of decomposition, including everything from pure humus below to the litter on the surface. Duff is a general, non-specific term.

Dune—A mound or ridge of loose sand piled up by the wind; common where sand is abundant and wind usually strong as along lake and sea shores and in some desert and semi-desert areas.

Engineering Practices—Soil and water conservation practices which are primarily designed to change the slope characteristics of land so that the amount and velocity of surface run-off and erosion are reduced; for example, the use of systems or devices for the disposal of excess water such as terraces, contour furrows, diversions, dams, dikes, channels and tile lines.

Erosion—The detachment and movement of the solid material of the land surface by wind, moving water or ice, and by such processes as landslides and creep.

Erosive—Tending to cause erosion; the term applies to the eroding agent, such as wind or water. The term has also been used interchangeably with “erodible,” but the word “erosive” is preferred when referring to the agent causing erosion, and “erodible” when referring to the material eroded.

Fallow—Allowing crop land to lie idle either tilled or untilled during the whole or greater portion of the growing season. Tillage is usually practiced to control weeds and encourage the storage of moisture in the soil.

Farm Pond—A small body of water retained behind a dam or held in a hole dug in the ground; of lesser area than a lake.

Fertility, Soil—The presence in a soil of the necessary elements, in sufficient amounts, in the proper balance and available for the growth of specified plants, when other factors, such as light, temperature, and the physical condition of the soil are favorable.

Fertilizer—Any material which is added to the soil to supply one or more of the plant nutrients.

Fertilizer, Commercial—Any industrial material, raw or processed, used to fertilize the soil. Includes such organic products as milorganite, but not barnyard manure.

Fertilizer Analysis—The percentage composition of a fertilizer, expressed in terms of nitrogen, phosphoric acid, and potash. For example, a fertilizer with a 6-12-6 analysis contains 6% nitrogen (N), 12% available phosphoric acid (P_2O_5), and 6% water-soluble potash (K_2O).

Field Border Plantings—Vegetation established on field borders to conserve soil and provide cover and food for wildlife.

Field Strip Cropping—A system of strip cropping in which crops are grown in parallel strips that are laid out across the general slope but that do not follow the contour. Strips of grass or close-growing crops are alternated with those in cultivated crops.

Filter Strip—A strip of permanent vegetation of sufficient width and vegetative density above farm ponds, diversion terraces and other structures to retard flow of run-off water, causing it to deposit soil, thereby preventing silting of structure or reservoir below.

Fine Textured Soil—A soil predominately silt and clay.

Firebreak—In forestry, an existing barrier, or one constructed before a fire occurs from which inflammable materials have been removed, designed to stop or check creeping or running fires. Also serves as a line from which to work and to facilitate the movement of men and equipment in fire suppression.

First Bottom—The normal flood plain of a stream. Some first bottom areas are flooded frequently, others at less frequent intervals. The term "high

bottom phase" is commonly applied to areas which rarely flood.

Fish Pond Management—The art of creating a pond environment suitable for fish production, and manipulating fish populations to make them most useful to man. May include fertilization and the control of undesirable pond weeds.

Flume—An open conduit of wood, concrete, stone or metal on a prepared grade, trestle, or bridge for the purpose of carrying water or other liquids across creeks, gullies, ravines, or other areas which lie along a canal or ditch location. It may also apply to an entire canal where it is elevated above natural ground for its entire length.

Food Chain (Biology)—A series of plant or animal species in a community, each of which is related to the next as a source of food.

Forest—Trees and associated plants covering an extensive area of land.

Freeboard (Hydraulics)—The vertical distance between the maximum water surface elevation anticipated in design and the top of retaining banks or structures. Freeboard is provided to prevent overtopping of structures because of wave action or the development of unforeseen conditions.

Glacial Soil Material—Material transported and deposited by glacial action from which soil may be developed.

Governing Body, Soil Conservation District—The appointed or elected supervisors (directors or commissioners) of a soil conservation district. There are usually five persons on this body, two of them appointed by the State Soil Conservation Committee, and three elected by the landowners in the district. The process of appointment or election varies with state laws.

Graded Terrace—A terrace having a constant or varia-

ble grade (slope in feet or inches per 100 feet of length) along its length.

Gradient—Change of elevation, velocity, pressure, or other characteristics per unit length; slope.

Grassed Waterway—A natural or constructed waterway, usually broad and shallow, covered with erosion-resistant grasses, used to conduct surface water from cropland.

Gravitational Water (Soils)—Water which exists in the large pores of the soil and which the force of gravity will remove from the soil when conditions for free drainage exist.

Green Manure Crop—Any crop grown for the purpose of being turned under while green, or soon after maturity, for soil improvement.

Gully—A channel or miniature valley cut by running water, but through which water commonly flows only during and immediately after heavy rains or during the melting of snow. A gully may be dendritic or branching or it may be linear, rather long, narrow and of uniform width. The distinction between gully and rill is one of depth. A gully is sufficiently deep that it would not be obliterated by normal tillage operation, whereas a rill is of lesser depth and would be smoothed by ordinary farm tillage.

Gully Control Plantings—The planting of seeds, seedlings, cuttings or transplants in gullies to establish or re-establish a vegetative cover adequate to control run-off and erosion and incidentally produce useful products.

Gully Erosion—Removal of soil by running water, with formation of channels that cannot be smoothed out completely by normal cultivation.

Habitat—The environment in which the life needs of a plant or animal are supplied.

Hardpan—A cemented (indurated) or hardened soil

horizon. This horizon which may have any texture is compacted or cemented by iron oxide, silica, organic matter or other substance.

Headland—A strip of unplowed land at the end of furrows or along a fence.

Hedgerow—A barrier of bushes, shrubs, or small trees growing close together in a line.

Humus—(1) Organic matter that has reached a more or less stable advanced stage of decomposition. It is usually characterized by its dark color, considerable content of nitrogen, a carbon-nitrogen ratio approaching 10:1 and by various physical and chemical properties, such as high base exchange capacity, water absorption and swelling. (2) The plant and animal residues in the soil that have undergone some appreciable degree of decomposition.

Hygroscopic Water (Soils)—Water which is so tightly held by the attraction of soil particles that it cannot be removed except as a gas, by raising the temperature above the boiling point of water. This water is unavailable to plants.

Impervious Soil—A soil resistant to penetration by water and usually by air and roots.

Improvement Cutting (Forestry)—A cutting made for the primary purpose of improving a stand of trees. Undesirable species, trees of poor form and those that are diseased or a source of insect infestation are removed so as to improve on quality and vigor of the stand.

Infiltration—The downward entry of water into soil or other material.

Intensive Cropping—Maximum use of the land by means of frequent succession of harvested crops.

Interplanting—In woodland, the setting out of young trees among existing trees or brushy growth. In orchards, the planting of farm crops among the trees, especially while the trees are too small to

occupy land completely. In cropland, the planting of several crops together on the same land; for example, the planting of beans with corn.

Irrigation—The application of water to soil to assist in the production of crops.

Land-capability—The suitability of land for use without damage. Land-capability as ordinarily used in the United States of America is an expression of the effect of physical land conditions, including climate, on the total suitability for use without damage for crops that require regular tillage, for grazing, for woodland, and for wildlife. Land-capability involves consideration of (a) the risks of land damage from erosion or other causes, and (b) the difficulties in land use owing to physical land characteristics including climate.

Land-capability Classification—A grouping of the mapping units of a soil survey into land-capability units, subclasses, classes and general divisions.

Land-capability Map—A map showing land-capability units, subclasses, and classes; or a soil survey map colored to show land-capability classes.

Land Leveling (Irrigation)—The reshaping of the ground surface to facilitate a more uniform application of irrigation water.

Leaching—The removal of soluble constituents from soils or other materials by percolating water.

Legume—A member of the legume or pulse family, *Leguminosae*. One of the most important and widely distributed plant families. The fruit is a "legume," or pod that opens along two sutures when ripe. Flowers are usually papilionaceous (butterfly-like). Leaves are alternate, have stipules, and are usually compound. Includes many valuable food and forage species, such as the peas, beans, peanuts, clovers, alfalfas, sweetclovers, lespedezas, vetches, and kudzu. Practically all leg-

umes are nitrogen-fixing plants, and many of the herbaceous species are used as cover and green manure crops. (Even legumes without feed or forage value, such as crotalaria and some lupines, are used for soil improvement.) The legume family contains timber trees such as locust, honey locust, and many tropical trees, and in addition, ornamental plants, including redbud, mimosa and wisteria.

Legume Inoculation—The addition of the proper strain of nitrogen-fixing bacteria to legume seed or to the soil in which the seed is to be planted. May be accomplished by (1) the addition of bacteria from pure cultures; (2) the addition of soil from a field on which the particular legume species has recently grown successfully. Inoculation is done so that the legume, with the aid of the associated bacteria, can fix nitrogen from the air instead of taking it from the soil.

Level Terrace—A terrace that follows the absolute contour, as contrasted with a graded terrace. Used only on permeable soils where conservation of moisture for crop use is particularly important or where outlet channels are impractical.

Lime—Lime from the strictly chemical standpoint refers to only one compound, namely calcium oxide (CaO). However, the term Lime is commonly used in agriculture to include a great variety of materials which are usually composed of the oxide, hydroxide, or carbonate of calcium, or of calcium and magnesium. The most commonly used forms of agricultural lime are ground limestone (carbonates), hydrated lime (hydroxides), burnt lime (oxides), marl and oyster shells.

Liming—The application of lime to land, primarily to reduce soil acidity and to supply calcium for plant growth. (Dolomitic limestone supplies both cal-

cium and magnesium.) May also improve soil structure, organic matter content, and nitrogen content of the soil by encouraging the growth of legumes and soil micro-organisms. Liming an acid soil to a pH value of about 6.5 is desirable for maintaining a high degree of availability of most of the nutrient elements required by plants.

Litter (Forestry)—A surface layer of loose organic debris in forests. It consists of freshly fallen or slightly decomposed organic materials.

Loam—(1) Soil containing a relatively even mixture of sand and silt and a somewhat smaller proportion of clay, generally a desirable quality. May be subdivided into texture classes like sandy loam, loam, silt loam and clay loam. (2) Specifically, soil material containing 7 to 27 per cent clay, 28 to 50 per cent silt, and less than 52 per cent sand.

Loess—Deposit of wind-transported fine-textured material, uniform and unstratified, mostly silt, but may contain some fine sand and clay.

Loose Rock Dam—A dam built of rock without the use of mortar; a rubble dam.

Mangum Terrace—A type of broad-base terrace first constructed and used in Franklin County, N. C., in 1885.

Masonry Dam—A dam built of rock and mortar.

Meadow—A field in which biennial or perennial crops are grown for hay.

Meadow Strip—A sloping field or strip of grassed land which, in addition to yielding a hay crop, acts as a broad shallow water channel during periods of run-off. Often used as a terrace outlet channel and usually much larger in extent than a grassed waterway.

Mulch—A natural or artificially applied layer of plant residue or other material such as stones, sand, paper, or brush on the surface of the soil.

Mulch Tillage—Tillage or preparation of soil in such a way that plant residues are left on the surface.

Nitrogen Fixation (Soils)—The assimilation of free nitrogen from the air by organisms in the soil so that the nitrogen eventually becomes available to plants.

Nitrogen-fixing Plant—A plant which can assimilate and fix the free nitrogen of the atmosphere by the aid of bacteria living in the root nodules. Legumes with the associated rhizobium bacteria in the root nodules are the most important nitrogen-fixing plants.

Nodule—A structure developed on the roots of most legumes and a few other plants in response to the stimulus of root nodule bacteria. Legumes bearing these nodules are nitrogen-fixing plants, utilizing atmospheric nitrogen instead of depending on nitrogen compounds in the soil.

Organic Matter—A general term for plant and animal material in or on the soil, in all stages of decomposition. Readily decomposed organic matter is often distinguished from the more stable forms that have already passed through the stage of rapid decomposition.

Organic Soil—A soil composed mainly of organic matter on a volume basis. (Twenty per cent or more organic matter by weight.)

Parent Material (Soils)—The horizon of weathered rock or partly weathered soil material from which the soil is formed. Horizon C of the soil profile.

Pasture Improvement—Any practice of grazing, mowing, fertilizing, liming, seeding, scattering droppings, contour furrowing, or other methods of management designed to improve the vegetation for grazing purposes.

Pasture Management—The application of practices to keep pasture plants growing actively over as long

a period as possible so that they will provide palatable feed of high nutritive value; to encourage the growth of desirable grasses and legumes, while crowding out weeds, brush, and inferior grasses.

Peat—Soil material consisting primarily of raw undecayed or slightly decomposed organic matter.

Percolation—The downward movement of water through the soil, especially the downward flow of water in saturated or nearly saturated soil.

Permanent Pasture—Grazing land occupied by perennial pasture plants or by self-seeding annuals, usually both, which remains unplowed for many years.

Permeability, Soil—The quality or state of a soil or of any horizon in the soil profile relating to the transmittal of water or air to all parts of the mass.

pH—A numerical measure of the acidity, or hydrogen ion activity of a soil. The neutral point is pH 7.0. All pH values below 7.0 are acid and all above 7.0 are alkaline. A change of one unit in pH value represents a tenfold change in hydrogen-ion concentration. Specifically, the logarithm of the reciprocal of the hydrogen-ion concentration. (Represents intensity of acidity, not the total exchangeable hydrogen, or quantity of potential acidity.)

Plant Food—(1) See Plant Nutrients. (2) Strictly speaking, plant food is the proteins, carbohydrates and fats manufactured within the plant from nutrient elements, but the term is used, particularly by the fertilizer trade, as synonymous with the plant-nutrient elements N-P-K, and the trace elements.

Plant Nutrients—The elements or groups of elements taken in by the plant which are essential to its growth, and used by it in elaboration of its food and tissues. Includes nutrients obtained from fertilizer ingredients.

Porosity, Soil—The percentage of the soil (or rock) volume which is not occupied by solid particles, including all pore space filled with air and water. The total porosity may be calculated from the formula: Per cent pore space = $1 - \frac{\text{volume weight}}{\text{specific gravity}} \times 100$. The total porosity includes both capillary and non-capillary porosity. Capillary porosity refers to the small pores that hold water by capillarity, while the non-capillary porosity refers to the larger pores that will not hold water by capillarity. A soil with low porosity, especially low non-capillary porosity, may be called a "non-porous" or "dense" soil, while a soil with high porosity, especially non-capillary porosity, may be called a "porous" or "open" soil.

Puddled Soil—A dense soil dominated by single grain structure, almost impervious to air and water. This condition results from the handling of a soil when it is in a wet, plastic condition, so that when dried, it becomes hard and cloddy.

Puddling—The act of destroying soil structure. Puddling reduces porosity and permeability. This process is sometimes used to reduce leakage of reservoirs and canals.

Rainfall Intensity—The rate at which rain is occurring at any given instant, usually expressed in inches per hour. Maximum Rainfall Intensity refers to the rate during any time when the rate is both maximum and uniform. Usually one or more standard time periods, such as 5 minutes, 10 minutes, are specified and then the term refers to an average rate calculated from the maximum amount that occurred during any such time period and the rate is not necessarily uniform.

Range—(1) Land that produces primarily native forage suitable for grazing by livestock. Also, forest

land producing forage. Usually relatively extensive areas of land suitable for grazing, but not suitable for cultivation, especially in arid, semi-arid, or forested regions. (2) A unit of grazing land used by an integral herd of livestock. (3) The geographic area of occurrence of plants or animals.

Range Management—The scientific management of range land for the continuous production of forage and livestock, consistent with the use of the land for other purposes.

Residual Soil—Soil formed in place by the disintegration and decomposition of rocks and the consequent weathering of the mineral materials. Presumably developed from the same kind of rock as that on which it lies.

Retention—The amount of precipitation upon a drainage area that does not escape as run-off. It is the difference between total precipitation and total run-off.

Ridge Terrace—A long, low ridge of earth with gently sloping sides, and a shallow channel along the upper side, to control erosion by diverting surface run-off across the slope instead of permitting it to flow uninterrupted down the slope. Types of ridge terraces include the broad base, drainage, graded, level, Mangum, narrow base, and Nichols terrace. Contrast with Bench Terrace.

Rill Erosion—Removal of soil by running water with formation of shallow channels that can be smoothed out completely by normal cultivation.

Rotation Pasture—A cultivated area used as a pasture one or more years as a part of crop rotation.

Sand—(1) Mineral soil grains 2.00 to 0.05 mm. in diameter according to U. S. Department of Agriculture standards; 2.00 to 0.02 mm. according to the International System. (2) Soil material containing 85% or more sand; percentage of silt, plus

1½ times the percentage of clay, shall not exceed 15%.

Saw Timber—Trees of a size and quality suitable for sawing into lumber.

Scalping—Spot removal of sod or other vegetation before planting tree seedlings.

Second-foot—A unit of measure of the volume of water flow; a cubic foot per second.

Sedimentary Rock—Rock derived from the deposition of sediments; examples, sandstone, shale and limestone.

Seedling—A plant grown from seed. In forest nursery practice, a tree which has not been transplanted in the nursery. In natural forest reproduction, a tree from seed, less than 3 feet in height.

Seed Tree—A tree intentionally left standing at the time of cutting a forest, to produce seed for natural seeding of the surrounding area.

Seepage—(1) Water escaping through or emerging from the ground along an extensive line or surface as contrasted with a spring where the water emerges from a localized spot. (2) The process by which water percolates through the soil.

Selective Cutting (Forestry)—A system of cutting in which single trees, usually the largest, or small groups of such trees, are removed and reproduction secured under the remaining stand and in the openings.

Self-pruning—The natural death and fall of branches, especially the lower branches, from live plants due to causes such as light and food deficiencies, decay, insect attack, snow, and ice.

Sheet Erosion—The removal of a fairly uniform layer of soil or material from the land surface by the action of rainfall and run-off water.

Shelterbelt—An extended windbreak of living trees and shrubs established and maintained for pro-

tection of farm lands over an area larger than a single farm.

Silt—(1) Small mineral soil grains intermediate between clay and sand; 0.05 to 0.002 mm. in diameter according to U. S. Department of Agriculture standards; 0.02 to 0.002 mm. in diameter according to the International System. (2) Water borne sediment with diameters of individual grains approaching that of silt. (3) Soil material containing 80% or more silt and less than 12% clay.

Silting—The deposition of water-borne sediments in lakes, reservoirs, stream channels, or overflow areas. It is caused by a decrease in the velocity of stream flow and a corresponding reduction in the amount and size of solid material which can be carried in suspension.

Sod—A surface layer of soil matted or held together by roots, rhizomes and stolons of grasses and other herbs.

Soil—Soil is a natural body developed from weathered minerals and decaying organic matter, covering the earth in a thin layer. It is a natural medium on the surface of the earth in which plants may grow.

Soil Conservation—The preservation of soil against deterioration and loss by using it within its capabilities, and applying the conservation practices needed for its protection and improvement. More specifically, soil conservation consists of using the land within the limits of economic practicability while safeguarding it against impoverishment or depletion by erosion, deposition, exhaustion of plant nutrients (through leaching, excessive cropping or overgrazing), accumulation of toxic salts, burning, waterlogging (inadequate drainage), improper cultivation or any type of improper use or failure to protect the land from soil loss or impairment of productiveness.

- Soil Conservation District (or Conservation District)*—An organization created under state law for developing and carrying out a program of soil and water conservation within its geographic boundaries. In most states a soil conservation district is a legal subdivision of the state government, autonomously controlled, with public powers.
- Soil Management*—The act or art of using soil for the production of crops. Continuous, profitable production involves the maintenance of the physical structure of the soil, the organic matter, the available nutrients, the biological activities, and the conservation of soil and water.
- Soil Profile*—A vertical section of the soil from the surface through all its horizons into the parent material.
- Soil Saving Dam*—A dam of earth or other material placed across a gully or other watercourse to impound silt and surface run-off, and to control erosion. Term sometimes used when referring only to the larger, permanent types of dams, as contrasted with check dams.
- Spillway*—A conduit in or around a dam for the escape of excess water.
- Splash Erosion*—A form of soil erosion resulting from soil splash caused by the impact of falling rain drops.
- Spoilbank*—A pile of soil, subsoil, rock or other material excavated from a drainage ditch, pond, or other cut.
- Sprinkler Irrigation*—Irrigation by means of spray from pipes or pipe projections above the soil surface.
- Spur Terrace*—A short terrace used to collect or divert run-off.
- State Soil Conservation Committee, Commission, or Board*—The state agency, established by state soil

conservation district enabling legislation, to assist with the administration of the provisions of the state soil conservation districts law.

Strip Cropping—Growing crops in a systematic arrangement of strips or bands to serve as vegetative barriers to wind and water erosion.

Structure, Soil—The arrangement of soil particles, either single grain or in aggregates, that make up the soil mass. The structure may refer to the natural arrangement of the soil when in place and undisturbed or to the soil at any degree of disturbance. The principal types of soil structure (aggregates) are platy, prismatic, columnar, blocky, nuciform, granular and crumb. The aggregates in these structure types vary in size and degree of stability. Structure is one of the important characteristics which determines the erodibility of soils.

Stubble Mulch—A protective cover provided by leaving plant residues of any previous crop as a mulch on the soil surface when preparing for and planting the following crop.

Subsoil—Roughly, that part of the solum under the topsoil; in soils not having clearly differentiated layers, the soil under the topsoil to a depth of about five feet.

Supplemental Pasture—Additional pasture for use in adverse weather conditions, usually annual forage crops for dry periods or winter time.

Surface Soil—The upper part of a cultivated soil commonly stirred by the plow or other tillage implements; or an equivalent depth, 5 to 8 inches, in non-arable soils.

Terrace—An embankment or ridge of earth constructed across a slope to control run-off and minimize soil erosion. Bench terraces and ridge terraces are the two general types.

Terrace Interval—Distance measured either vertically or horizontally between corresponding points on two adjacent terraces. The vertical interval (difference in elevation between stake lines) is used almost exclusively in staking terrace lines for construction. For the top or first terrace it is measured between the top of the hill and the center of the terrace.

Terrace System—A complete series of terraces occupying a slope and discharging run-off into one or more outlet channels.

Topsoil—A distinguishable layer at the surface of the soil, often 6 or 7 inches in thickness. In dark-colored soils, the surface layer or layers distinctly higher in organic matter than the material below. In many light-colored soils, the layers that lie over material of heavier texture and more pronounced structure, provided such material occurs within about 15 inches of the surface. In uniform soil material the soil to plow depth. The thickness of the original topsoil, before accelerated erosion, is commonly used as a standard against which to estimate the degree of accelerated erosion.

Undercutting (Erosion)—Removal of material at the base of a steep slope or cliff by falling water, a stream, wind erosion, or wave action. This removal steepens the slope or produces an overhanging cliff.

Wash—A gully. In southwestern United States, the dry bed of an intermittent stream, sometimes at the bottom of a canyon.

Water-logged—A condition of land where the ground water stands at a level that is detrimental to plants. It may result from over-irrigation, seepage, or inadequate drainage.

Water Spreading—The application of water to lands for the purpose of increasing the growth of nat-

ural vegetation or to store it in the ground for subsequent withdrawal by pumps for irrigation.

Water Table—The upper surface of free ground water in a zone of saturation except when separated from an underlying body of ground water by unsaturated material.

Water Table, Perched—The upper surface of a body of free ground water in a zone of saturation, separated by unsaturated material from an underlying body of ground water in a different zone of saturation.

Watershed—(1) The total land area, regardless of size, above a given point on a waterway that contributes run-off water to the flow at that point. (2) A major drainage-area subdivision of a drainage basin. On the basis of this concept the United States is generally divided into some 150 watersheds such as the Cheyenne, Delaware, Pecos, Pee Dee, Muskingum, and Willamette.

Waterway—A natural course for the flow of water.

Weathering—The physical and chemical disintegration and decomposition of rocks and minerals.

Weir—A dam across a stream for diverting or for measuring the flow.

Weir Notch—The opening in a weir for the passage of water.

Wildlife Border—A strip of low growing plants (herbaceous plants, shrubs, or both) along edges of woodland, established by planting seeds or plants or developed by release cutting of competing woody plants.

Wind Erosion—The detachment, transportation, and deposition of soil by the action of wind. The removal and redeposition may be in more or less uniform layers or as localized blowouts and dunes.

Wind Strip Cropping—The production of crops in long, relatively narrow strips, placed crosswise of the

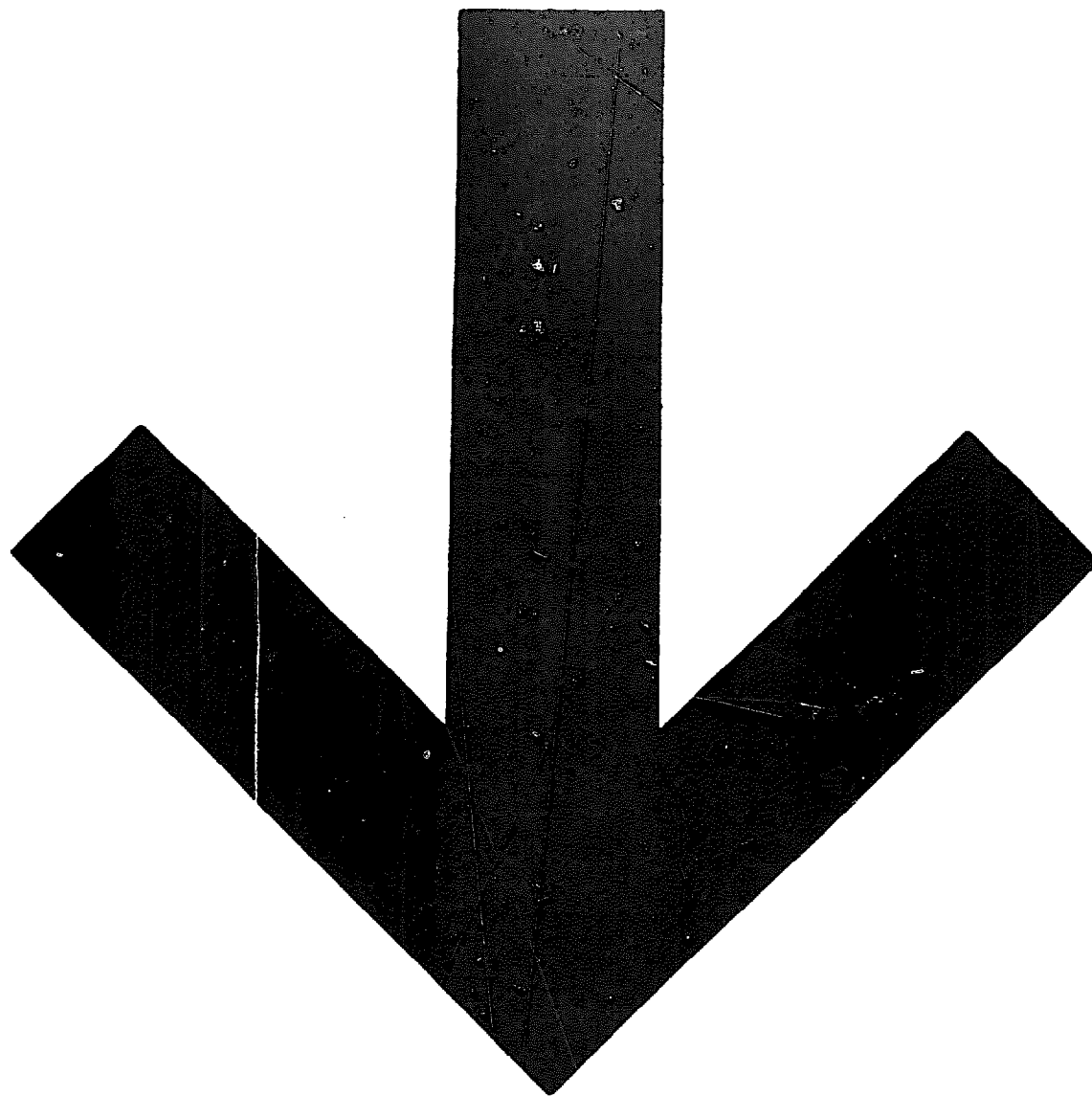

INDEX

- Alkali469
- Bank stabilization ..264, 339
- Beachgrass276
- Bedding (*See* Drainage)
- Bench mark470
- Benefits of con-
servationxi-xxii
- Bentonite231
- Berms261, 378
- Chaining 50
- Channels, lined262
- Chisel planting192
- Contour farming 87
 - layout 87
 - planting 97
 - plowing 91
 - problems 92
- Contour fences101
 - bracing105
 - construction103
 - layout102
- Critical areas270
- Cropping systems 23
- Crop rotations 28
- Cruiser stick310
- Diversions175, 260
- Drainage365
 - advantages366
- Drainage, surface371
 - bedding375, 470
 - berms378
 - construction381
 - cross slope372
 - field ditch375
 - maintenance386
 - outlets370
 - parallel ditch374
 - random ditch271
- Drainage, underground .391
 - backfilling403
 - blinding403
 - depth396
 - grade399
 - size394
 - spacing399
 - trenching399
- Engineering
 - instruments 39
 - Abney level 43
 - care of 45
 - chain 50
 - dumpy level 41
 - hand level 41
 - rod 45
 - tripod 47
 - wye level 41
- Erosion 13
 - construction sites ..255
 - degree 13
 - gully13, 235
 - sheet488
 - urban255
 - wind198
- Fence rows (wildlife)...320
- Fences101
 - contour101
 - living320
- Fibrous materials269
- Gullies235
 - filling and shaping ..240
- Irrigation407
 - border414
 - contour furrow416
 - controlled flooding ..418
 - corrugation415
 - furrow416

- sprinkler418
- supplemental418
- Land capability classes
 - Class I 15
 - Class II 15
 - Class III 16
 - Class IV 18
 - Class V 20
 - Class VI 20
 - Class VII 21
 - Class VIII 21
- Land features 3
- Land inventory 2
- Land smoothing388
- Land use 1
- Marshes322
- Minimum tillage183
 - lister planter188
 - mulch planting186
 - mulch tillage185
 - no-till191
 - plow plant195
 - slot planting189
 - strip tillage190
 - till planting192
- Monoculture 34
- Mulch266
- Mulch planting (*See* Minimum tillage)
- Mulch tillage (*See* Minimum tillage)
- No-till (*See* Minimum tillage)
- Odd areas326
- Outlets 69
 - drainage368, 377
 - terrace69, 86, 134
- Pacing 50
- Pastures343
 - fertilizing346, 351
 - grazing352
 - improvement343
 - mowing356
 - renovating346
 - seeding349
- Planting stock301
- Plow plant (*See* Minimum tillage)
- Ponds201
- construction222
- core wall224
- design208
- excavated227
- fertilizing333
- fill225
- management328
- sealing230
- site205
- survey208
- Profile, engineering
 - survey 55
- Rainfall 58
 - factor 60
 - frequency 58
 - rate 58
- Range357
 - condition359
 - conservation357
 - inventory358
- Recreation423
 - camping427
 - fishing433
 - hunting areas429
 - picnic areas424
 - shooting preserves ..430
 - use of land for438
 - vacation farms435
- Residue
 - management193, 198
 - (*See also* Minimum tillage)
- Runoff, rate, cfs 59
- Sandblows275
- Sediment255
 - basins262
- Shelterbelts283
- Slope 52
- Slot planting (*See* Minimum tillage)
- Sodding273
- Soil2, 489
 - air and water
 - movement 6
 - color 9
 - depth 5
 - productivity 10
 - scientist 2
 - slope 12

- structure7, 24, 491
- surveysvii, 2, 259
- texture 11
- tilth24, 29
- Soil Conservation
 - Service 2
- Spillway215
 - pipe218
 - vegetated216
- Streambank protection ..339
- Strip cropping109
 - area122
 - buffer122
 - contour111
 - farming122
 - field121
 - laying out115
 - planting116
 - width121
- Strip tillage (*See*
Minimum tillage)
- Structures243
 - chutes250
 - drop inlets245
 - drop spillways248
 - permanent245
 - temporary245
- Stubble mulch198
- Surveying 40
- Sweeps199
 - (*See also*
Minimum tillage)
- Terraces131
 - construction140
 - diversion175
 - farming152
 - grade139
 - grass backslope ...173
 - harvesting crops on .163
 - interval136
 - length135
 - level134
- maintaining151
- outlets134
- parallel166
- planning133
- planting158
- plowing152
- staking138
- underground
 - outlets171
- Till planting (*See*
Minimum tillage)
- Waterways69, 86
 - construction 76
 - design 71
 - fertilizing 82
 - location 70
 - maintaining 85
 - protecting 84
 - repair 85
 - seeding 80
 - shape 75
 - size 72
- Wheel track planting ...196
 - (*See also*
Minimum tillage)
- Wildlife315
 - borders336
 - fences and hedges ..320
 - managing land for ..318
 - marshes322
 - needs316
 - pond management ..328
 - wasteland326
- Windbreaks283
- Woodlands291
 - improving291
 - measuring310
 - planting296
 - protecting306
 - pruning293
 - thinning292