

**EM 22**

**Modern dairy farming in warm climate  
zones**

Volume 2

Bart Gietema

© Agromisa Foundation, Wageningen, 2005.

*All rights reserved. No part of this book may be reproduced in any form, by print, photocopy, microfilm or any other means, without written permission from the publisher.*

First edition: 2005

Author: Bart Gietema

ISBN: 90 5285 015 1/016 X  
NUGI: 835

# Foreword

This guide provides 'farm level' information and instruction on hand and machine milking of dairy cows including physiological aspects.

The construction, operation and maintenance of milking machine equipment receives due attention. However, the guide does not offer details of the latest auxiliary equipment; the text is mainly about 'basic equipment' in use everywhere where machine milking is applied.

The guide also includes a chapter on milk composition and the quality and handling of milk on the farm.

Questionnaires and suggestions for practical work have been added to make the text more suitable for formal or informal training situations.

In this guide, material has been used from the publication 'Melkwinning' (1986, in Dutch) and subsequent publications made by what is now the Information and Expertise Centre on Animal Husbandry (IKC-V) at Lelystad in the Netherlands. Practically all the illustrations are from these publications.

The 'practicals' in the guide and the other 'instructional' chapters were mainly devised by the Dairy Training Centre Friesland.

The present text is a reprint of an earlier text, with some slight changes here and there.

IJhorst, NL, December 2003

B.Gietema

compilation, editing and layout

Email: <b-n.gietema@hetnet.nl>

# Contents

<b>1</b>	<b>Introduction</b>	<b>6</b>
<b>2</b>	<b>Milk secretion</b>	<b>7</b>
2.1	Structure of the udder	7
2.2	Milk ejection	8
<b>3</b>	<b>Hand milking</b>	<b>10</b>
3.1	Udder preparation	10
3.2	The technique of hand milking	10
3.3	Hand milking in brief	12
3.4	Daily cleaning of the milking equipment	13
<b>4</b>	<b>Construction of the milking machine</b>	<b>15</b>
4.1	The vacuum pump and associated components	15
4.2	Milking units	25
<b>5</b>	<b>Milk transport and milk flows on the farm</b>	<b>35</b>
5.1	The milk pipeline and the receiver	35
5.2	The milk releaser pump	36
5.3	Stand-by equipment	37
<b>6</b>	<b>Machine milking</b>	<b>39</b>
<b>7</b>	<b>Machine milking : successive actions required of the milker</b>	<b>46</b>
7.1	Putting the milking equipment into working order	46
7.2	What the milker should do when actually milking	46
7.3	Special cases	48
7.4	Machine milking : what can go wrong and what should then be done ?	49
<b>8</b>	<b>Cleaning and disinfection of milking equipment</b>	<b>53</b>
8.1	Daily cleaning and disinfection routine: bucket milking machine	54
8.2	Daily cleaning and disinfection routine: milk pipeline installations	57
<b>9</b>	<b>Mastitis and its prevention</b>	<b>60</b>
9.1	What is mastitis?	60
9.2	How does mastitis develop ?	61
9.3	Mastitis prevention	62
<b>10</b>	<b>Periodical maintenance of the milking machine</b>	<b>64</b>
<b>11</b>	<b>Tests carried out by milking machine technicians</b>	<b>68</b>
11.1	Norms 68	
11.2	Test equipment	70
11.3	Various tests carried out on the milking machine	71
11.4	Further maintenance jobs	80
<b>12</b>	<b>The choice of a milking system</b>	<b>83</b>
<b>13</b>	<b>Milk cooling = conservation</b>	<b>85</b>
13.1	Relatively simple methods of cooling milk at the farm	85

13.2 Mechanical refrigeration (tank cooling)	86
<b>14 Milk : composition, quality and processing</b>	<b>91</b>
14.1 The composition of milk	91
14.2 Milk quality	93
14.3 The processing of milk in the factory	97

# 1 Introduction

In dairy farming, there is a direct link between the income of the farmer and how well his/her cows are milked. Milking is done every day. For these reasons on a dairy farm **milking should be taken very seriously. Good milking practice is good business practice.**

Good milking is a skill that can be learned by practice, but some people learn more rapidly than others. The willingness to break with wrong habits is also an important point.

Whether to milk cows by hand or by machine is a question with no easy answer.

When labour costs are low and the dairy herd small, it is quite normal to milk the cows by hand.

As far as milk production and udder health are concerned, hand milking is quite in order, on condition that it is done correctly by skilled persons.

However, more and more dairy farms all over the world use milking machines. With machine milking it is possible to milk more than one cow at a time, which increases the output of a milker.

When there are few cows, it does not pay to install an expensive milking machine when milking can be done by hand.

Whichever milking method is used, there are **some general rules in milking** which should always be followed:

- Milk at regular intervals.
- Maintain peace and quiet in the cowshed; all cows should be treated gently but firmly.
- Maintain hygiene: clean cows, clean equipment and the milker him/herself should have clean hands, short fingernails and wear clean clothing.

It can be said that milking is a kind of teamwork between the cow and the milker.

Milk quickly and evenly, with as little pulling of the teats as possible (hand milking). This brings the cows into a contented state and gives them confidence in the milker, if one may say that.

In the case of machine milking, it is less the milker than the proper functioning of the machine which is very important. Of course this has something to do with the operator as well.

The **main characteristics** of good milking are:

- 1 The milking routine does not stand in the way of high yields.
- 2 The quality of the milk meets certain hygienic standards.
- 3 The risk of udder infection is small.
- 4 The physical and mental effort required from the milker is not too great and the environmental conditions are acceptable.

Good machine milking means that everything possible is done to make the cow contented; in other words that a properly functioning machine is correctly applied to the cow. Hygiene (milk quality) and mastitis prevention receive particular attention.

## 2 Milk secretion

### 2.1 Structure of the udder

The udder consists of four separate parts called **quarters**. Strong suspensory ligaments support the udder and attach it to the skeleton of the cow. They divide the udder into two halves. There is no clearly visible separation between the two quarters of one side, but the fact that just one of them can produce abnormal milk shows that these quarters do not communicate.

Each quarter ends in a **teat**. At the lower end of the teat is the **teat canal** (also called streak canal); it is about 1 cm long and has a ring of muscle tissue that can keep its orifice (opening) closed. This muscle is called a **sphincter** (sphincter = ring of muscle tissue guarding/closing an orifice in the body).

An 'easy milking' cow is a cow whose teats open easily. In dairy farming cows are selected for 'ease of milking', among other things.

Except at milking time, the teat orifice should be tightly closed to prevent the penetration of bacteria into the udder.

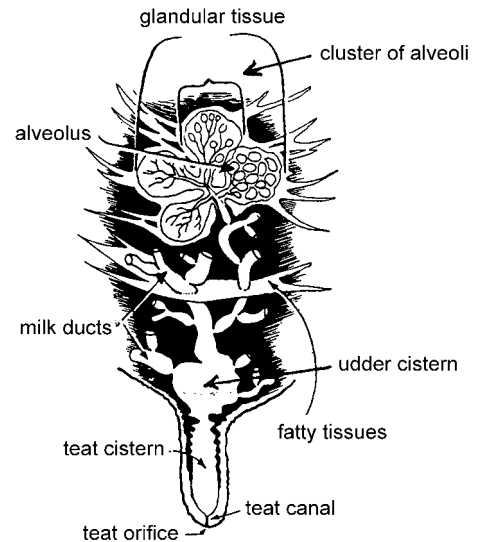

Figure 1: Vertical section of a quarter of the udder

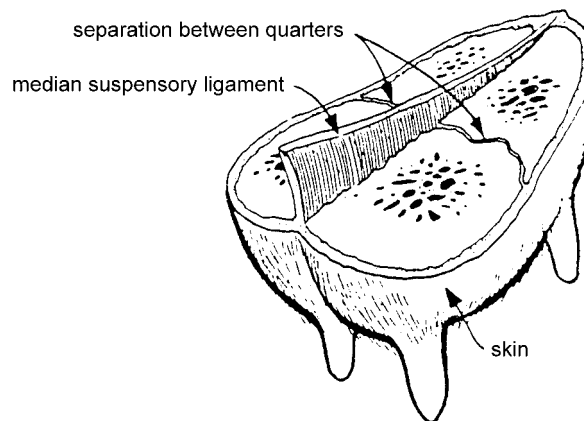

Figure 2: Horizontal cross-section of the udder

Inside the teat is a cavity, the **teat cistern**. It connects with the udder cistern (the udder has four such cisterns). The walls of the cisterns are very sensitive and can easily be damaged, for instance by incorrect milking.

About 20 to 50 large **milk ducts** empty into the udder cistern, which has a capacity of about 1 litre. The ducts branch out, away from the cistern, becoming smaller and smaller, until they end in glandular lobes, called **alveoli** (s.alveolus) in which the milk is 'manufactured' (proteins, fats, sugars; a continuous process). In a well-developed udder there are millions of such alveoli, grouped in clusters. In the udder the milk is stored (held) by capillary forces in the alveoli and small ducts and by muscles in larger ducts. Pressure on the alveoli results in ejection of the milk. Complete emptying of the alveoli is not possible; after milking there will always be (some) so-called residual milk in the udder.

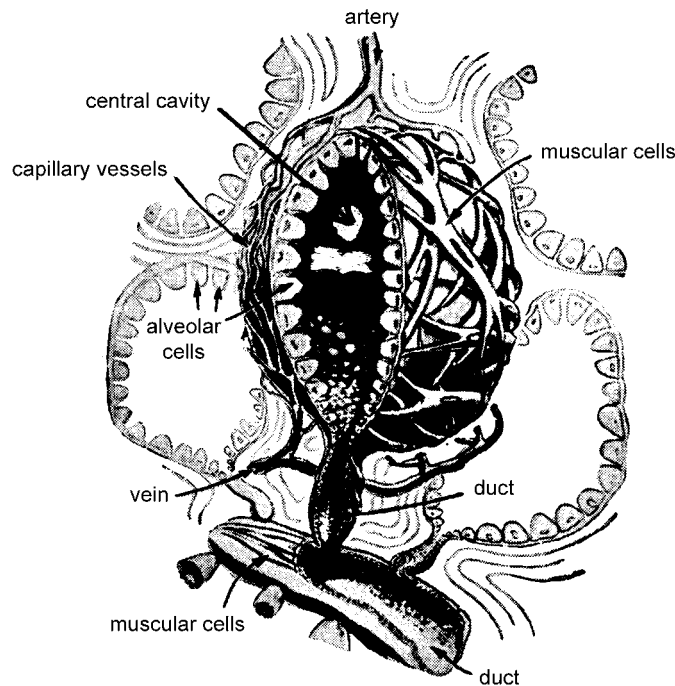

Figure 3: Alveolus with alveolar cells and ducts

## 2.2 Milk ejection

The milk in the cistern areas can be ‘harvested’ at milking by overcoming the resistance of the teat end sphincter. But the cow must **actively cooperate** in order to obtain the milk stored in the higher parts of the udder.

The cow receives signals that she is going to be milked; for example, sights and sounds of milking equipment, the milking of a cow standing near by, the feeding of some concentrate or cleaning/massage of udder and udder teats. These impressions are registered in the brain and transmitted to the pituitary gland. This gland releases the hormone **oxytocin** into the bloodstream, which is then transported by the blood (via the heart) to the alveoli.

The action of the oxytocin hormone is to make the alveoli contract; the milk is squeezed out into the milk ducts and down into the cistern.

The duct system itself is opened by direct nerve impulses generated by the massage of the teats and the udder.

The milk is said to be **‘let down’** by the cow. Hence ‘let down effect’.

Oxytocin release is a complicated process. It appears it is mainly secreted into the bloodstream at the start of actual milking (hand milking or machine milking), or when the udder is being quite vigorously ‘prepared’ by the milker. Feeding some concentrate, udder cleaning/massage and the release of foremilk, in particular, produce strong ‘signals’. Milking itself also induces the release of oxytocin.

In practice, what matters is giving strong signals to the cow (to release oxytocin) and doing this at the right moment.

The cow should get used to the milking process; ‘routine’ is an important factor.

Some people say that the secretion of oxytocin, and with it the cow’s willingness to cooperate, demand **harmonious and undisturbed interaction** between the **cow and the milker** (with his/her machine). The cow must feel safe and in good hands all the time; if not, insufficient oxytocin will be released. If the cow is disturbed (fear, pain, noise) the ‘letting down’ process may even be completely blocked by the hormone adrenalin. The body is then prepared for defence, instead of for milking!



All this explains why the milking routine should always be **regular** and **undisturbed** by anything that is unusual, with a **properly functioning machine** in the case of machine milking.

Not all the milk can be drawn from the udder; some milk is always left behind (residual milk). In this respect there are variations per quarter, per cow and per breed, depending on the structure of the udder. Cows which are difficult to milk may empty their udders completely.

The breed of the cow is an important factor; tropical breeds are generally not easily milked, for one reason or another.

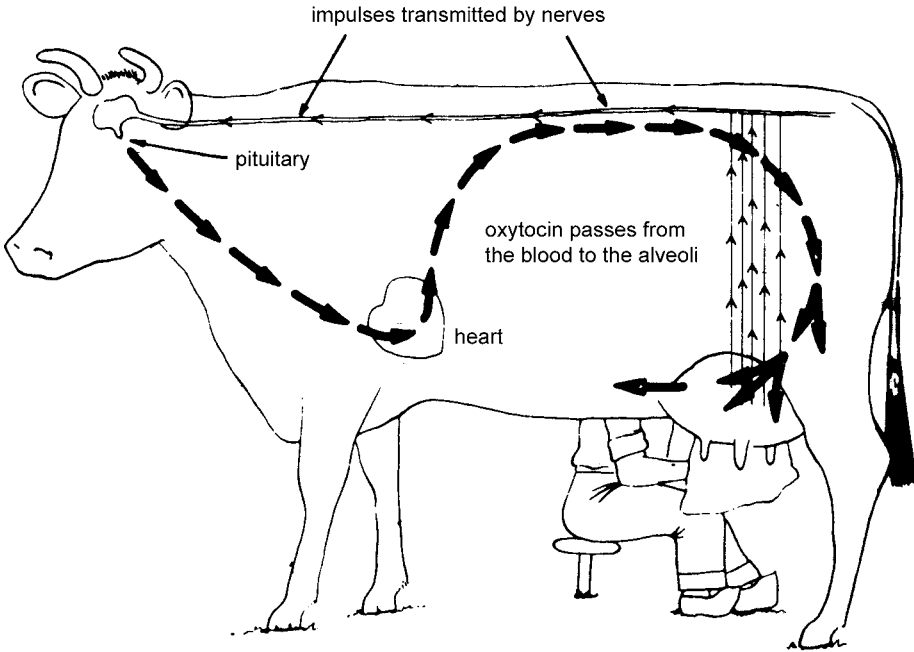

Figure 4: 'let down effect'

## 3 Hand milking

### 3.1 Udder preparation

Before actually starting to milk, it is necessary to ‘prepare’ the udder.

The main actions of udder preparation are:

- the cleaning of the teats and the udder itself so that there is no dirt contaminating the milk during milking;
- the checking of the foremilk for mastitis.

At the same time both actions tell the cow (as you might say) that milking is about to start (oxytocin release).

In hand milking, udder **cleaning** must be emphasized, whereas in machine milking the ‘**let-down**’ **signal** is more important. In hand milking the chance that dirt, hairs or skin particles fall into the bucket during milking is greater than in machine milking, at least when handstripping is omitted.

In machine milking dry cleaning may be sufficient, especially when the cows are kept in a pasture or in a loose housing system with cubicles. Dry cleaning takes little time and the transfer of udder pathogens from one cow to another is less likely to occur than during wet cleaning.

When udders are really dirty, dry cleaning is not sufficient.

In hand milking, the washing of udder and teats is the best guarantee for high-quality milk as far as cleanliness is concerned. The flank of the cow should also be cleaned.

For efficient cleaning it is necessary to clip the hair of the udder regularly and perhaps part of the flank as well.

After washing, the udder has to be dried (with a cloth or paper towel).

When the udders are cleaned with water from a bucket and a cloth, the water and the cloth should be renewed regularly, especially in the case of herds with dirty udders (one cloth per cow).

Adding a disinfectant to the washing water may reduce the transfer of pathogens.

What is the best temperature for the washing water? under cold conditions (after a cold night for instance), the use of lukewarm water (about 40°C) may be advantageous.

Warm water may remove fat from the skin and increase the risk of sore teats.

Very cold water should not be used because it may disturb the milk ejection.

An important part of udder preparation is **checking the foremilk**. This requires a foremilk cup. Sometimes one can test the foremilk on the floor, in the case of a parlour with special black tiles.

The foremilk is taken after the udder has been washed. Apart from being a check on mastitis, it may be argued that the taking away of foremilk removes pathogens (harmful bacteria) that may have penetrated into the teat canal between two milkings. And it is a signal to the cow that milking is about to start (oxytocin release).

### 3.2 The technique of hand milking

It appears that **forced, rhythmic squeezing** with the **full fist** maintains a strong let-down reflex. Secondly, it is also a rapid way of evacuating milk from the udder, at least in cows with a normal teat size. The third advantage of forced hand milking is the more or less permanent stretching of the teat canal, which is important for ‘hard-milking’ cows.

Cows have good or poor milking characteristics and there is probably not much that one can do about this. But it is sometimes said that strong hand milking has a favourable effect on the flow rate, whilst

poor milking (weak, irregular squeezing) produces cows that milk poorly. For this reason it may be advantageous for good and poor milkers to change cows, notwithstanding the fact that a very regular milking routine - the same milker always milking his or her own cows in the same order - is also very desirable.



Figure 5:

For cows with small teats, milking with the full fist or hand is not always possible. In that case other grips are applied. One of these grips is sliding the teats between thumb and forefinger. This grip is considered to be a very bad one for milk flow rate and udder health.

If one wants to milk a cow rapidly, it is possible to have two milkers milking the four quarters at the same time. This method may be profitable in respect of milking time (possibly resulting in a more complete milk evacuation), but is not very efficient with regard to labour use. It is also open to discussion whether a cow responds well to stimulation applied by two milkers, which can never be very regular.

In hand milking, **stripping** was considered to be very important, at least until recently. The belief that the last drop had to be removed (because it was lost if left in the udder) was the reason for the stripping technique applied in hand milking for many years.

Nowadays it is known that there is always some milk left in the udder (residual milk) and that this does not harm milk production or udder health. Thus careful removal of the 'last drops' makes no sense as far as production and health is concerned whilst it takes more labour time.

In hand milking it is very often necessary **to tie the hind legs** of the cows. Otherwise the risk of overturning the bucket is great, especially with young or excited animals. In addition, the bucket has to be held between the legs of the milker.

Normally the milker sits on a special seat (milking stool), on the right side of the cow.

Touching the flank of the animal with the head or shoulder should be discouraged, because dirt or hairs may fall into the bucket.

It is advisable to start by milking the two front quarters. They can be reached easily and do not hamper the milking of the rear quarters when they are empty.

Milking the two rear quarters is not so easy when one sits on the right side of the cow. However, it is not good practice to milk a front and a rear quarter at the same time. The ratio of milk quantities in front and rear quarters is 40 : 60 on the average; so when both quarters are milked at the same time, the milk is not removed very well from one of the two quarters.

If possible (teat size!), forced regular and rhythmic squeezing of the teats, by the full fist or hand, is the most efficient way to milk a cow, with regard to milk evacuation and milk flow rate; it also **maintains** good milking characteristics (milk flow rate and completeness of milk evacuation).

In good hand milking, the force and rate of the squeezing are adapted to the milking characteristics of the cow. For hard-milking cows the squeezing rate should be lower than for easy-milking cows.

The teat size also plays a role. In general, a good milker feels which is the right method to apply to each cow.

When the milk is almost completely removed from the front quarters by the full fist or hand grip, the milker should start milking the rear quarters.

When all quarters have been emptied to the same degree, the milker should return to the front quarters and milk them once more, if necessary with special grips (stripping grips). Then the milker should do the same with the rear quarters.

### 3.3 Hand milking in brief

#### **preparation, in general:**

- the milker should
  - wear clean clothing and footwear (boots)
  - have clean hands and short (clean) fingernails
- in the milkshed
  - remove manure that is lying underneath the cows
  - provide clean straw (litter)
  - bind the tails of the cows
  - never distribute strong-smelling feedstuffs during milking as they can affect the milk; this applies in particular to poor-quality silage
- the following equipment is required (per person):
  - (milk cans, funnel and milk filter)
  - milk bucket, 15-18 litres
  - bucket for udder cleaning, 10 litres
  - dry towels
  - funnel, with a special milk filter
  - foremilk cup, for mastitis-testing
  - rope (or special strap) for tying hind legs of cows
  - a stool (seat) for the milker

N.B.: the milk bucket, the cans and the funnel should have been disinfected before milking starts

#### **udder preparation:**

- tie the legs of 'difficult' cows
- clean the udder with (lukewarm) water, especially the teats and their immediate surroundings
- then dry the udder with a (dry) towel and remove the dirt on the flank of the cow;
- inspect the foremilk with the foremilk cup; in the case of mastitis take the necessary measures

#### **actual milking:**

- sit on the right side of the cow
- keep the milk bucket squeezed between the thighs; put the right leg around the bucket, with the bottom of the bucket placed against the left foot
- the handle of the bucket should be on the milker's side and one eye of the handle should rest in the 'hollow' of the milker's right knee
- place the left knee against the cow's leg

- keep the back straight and do not lean against the flank of the cow so that dirt particles and hairs do not fall into the milk bucket
- milk the cow by full fist or hand grip
  - the front quarter on the left with the right hand and the front quarter on the right with the left hand
  - the rear quarter on the left with the right hand and the rear quarter on the right with the left hand
  - milk the two front quarters first (until the milk is nearly all removed) and then the two rear quarters
  - milk the quarters once more, in that order
- empty the bucket into the milk can (use milk filter)
- when milking is finished, clean the milking equipment

**N.B.:** a milk filter *cannot prevent the passage of bacteria (!)* or foreign matter that has dissolved in the milk during the milking process

### 3.4 Daily cleaning of the milking equipment

The **daily cleaning of the milking equipment** (after each milking) is very important. Milk residues should be completely removed each time, in particular the fatty particles in the milk. This reduces the risk of contamination of the milk at the next milking.

The following equipment is needed for the daily cleaning job:

- hot and cold water
- a detergent (which is also an antiseptic)
- two brushes (one for outer and one for inner surfaces)
- three trays (tubs, troughs)

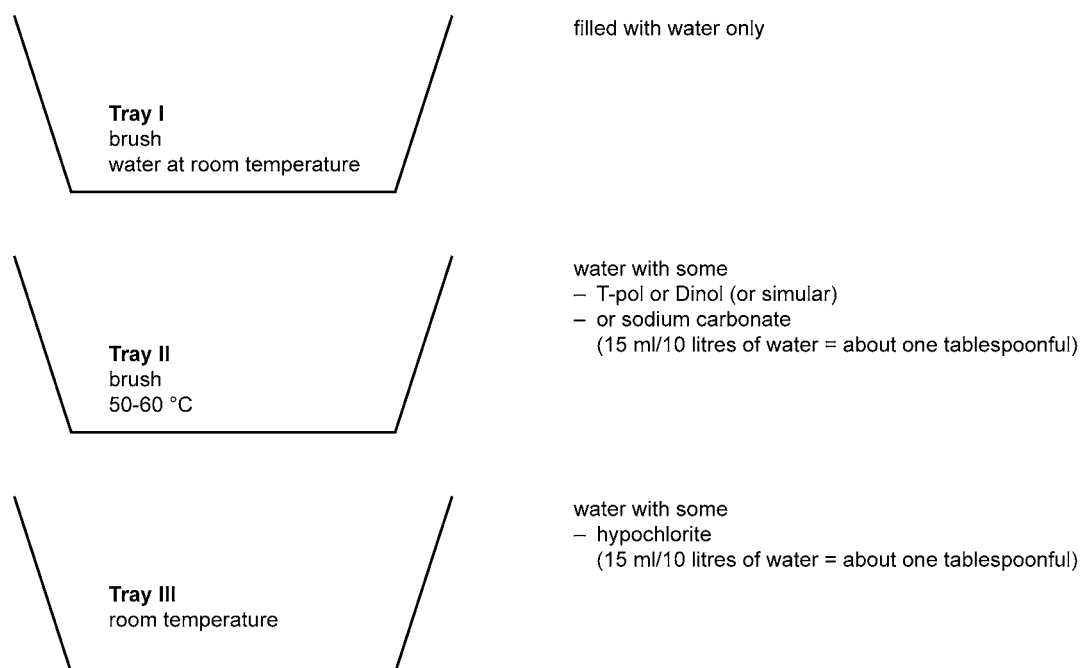

Figure 6:

#### Actual cleaning

- a remove milk residues with cold water
- b scrub the outer surfaces of the equipment in tray I
- c scrub the inner surfaces in tray II
- d disinfect in tray III

e place all equipment on a drying rack (preferably in the sun! - sun rays are very good disinfectants)  
f scrub and clean the trays; clean the brushes

treatments a,b,c,d,e : the milk bucket(s) and the milk cans  
a,c,d,e : the milk filter and the foremilk cup  
b,c,d,e : the bucket used for udder cleaning  
b,c,d,e : the towels

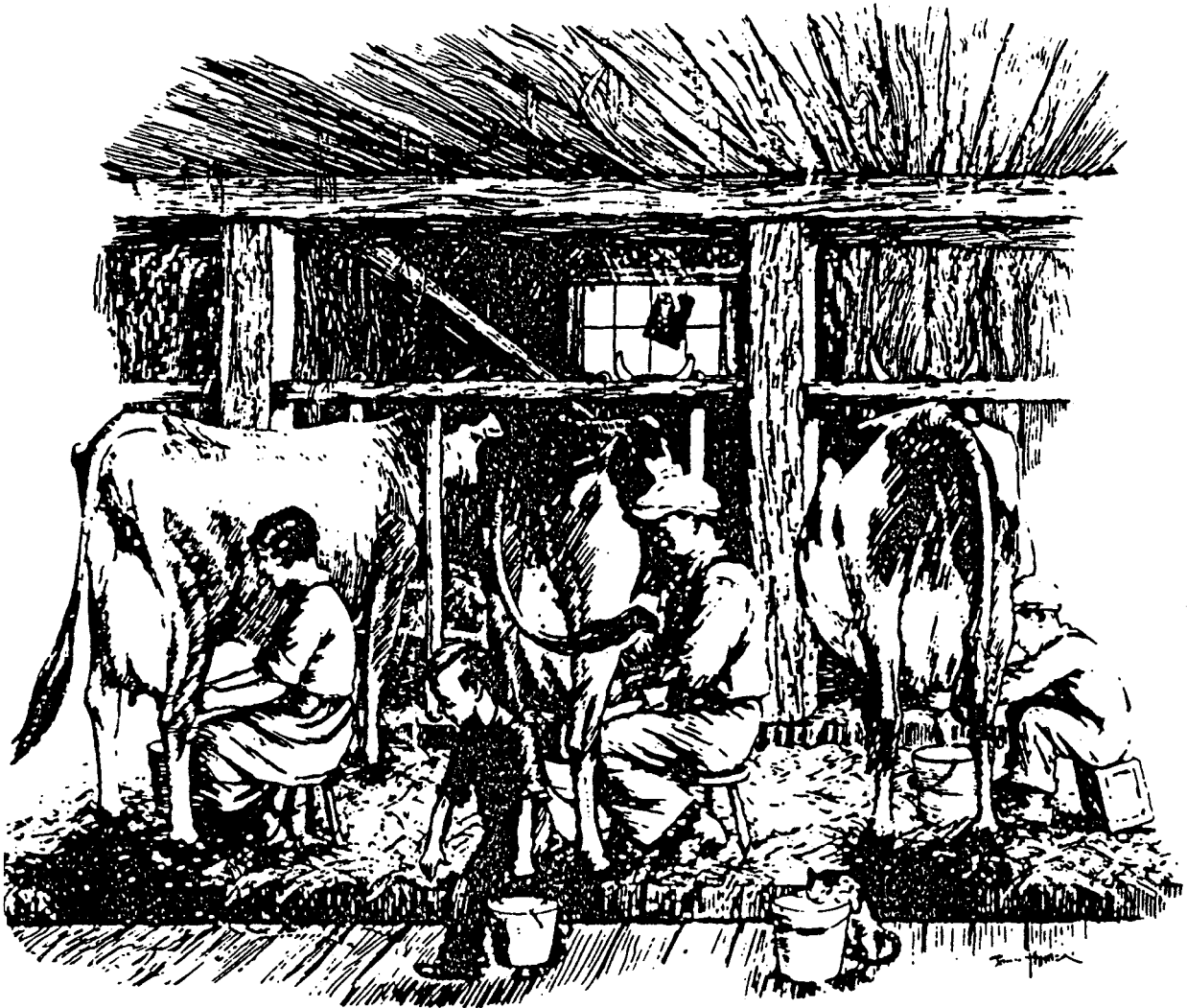

*Figure 7: A farm family - how it was in the Netherlands about sixty years ago. Peaceful and idyllic.*

## 4 Construction of the milking machine

### General

A calf can draw milk from the udder by alternating suction with massage. The milking machine does the same with suction generated by the **vacuum pump**. An **air pipeline** connects the pump with all places where vacuum is required.

A so-called **interceptor** is fitted near the vacuum pump. It serves to collect moisture and dirt, preventing them from entering the vacuum pump.

Nearly all milking machines operate at a 'vacuum' of 40 to 50 kPa (1 kPa = 0.75 cm Hg). This is sufficient to suck the milk out of the teats. The vacuum pump would normally draw more air from the system than is admitted during milking. The vacuum would become too 'strong'. To prevent this (to maintain the vacuum at a nearly constant level), each milking machine has a **vacuum-regulator**.

The vacuum level in the system is indicated by a **vacuum gauge** (also called vacuum-meter).

### Types of milking machines

In the milking machine of the **bucket-type**, the **vacuum tube** forms the connection between the air pipeline and the **milking unit**. In order to be able to connect the vacuum tube with the air pipeline, the air pipeline has **vacuum taps** in places where they are needed.

The **standing milking unit** consists of **bucket, lid, milk tube, pulsator, pulsation tube(s), milk claw and teatcups**.

With the **hanging** type of bucket, milk tube, pulsation tube(s) and milk claw are superfluous. However, this type of bucket is quite rare and will not receive much attention in this guide.

In another type of milking machine, the milk that is drawn from the cow does not go into a bucket, but passes directly through a milk pipeline to a central tank. This is called a **milk pipeline** milking installation.

In the following section an attempt is made to provide details that are relevant **at farm level**, and knowledge of which promotes the proper use of the milking machine.

### 4.1 The vacuum pump and associated components

#### 4.1.1 The pump

The vacuum pump can be driven by an electro-motor, an internal combustion engine or by the power take-off of a tractor.

A fixed milking installation normally has an electro-motor.

Usually the pump has a V-belt drive;

$$T_2 = \frac{D_1 \times T_1}{D_2}$$

in which

$T_2$  = number of revolutions of vacuum pump

$D_1$  = diameter pulley of motor

$T_1$  = number of revolutions of motor

$D_2$  = diameter pulley of vacuum pump

The drive can also be direct; this is cheaper but does not allow variation in the number of revolutions of the pump.

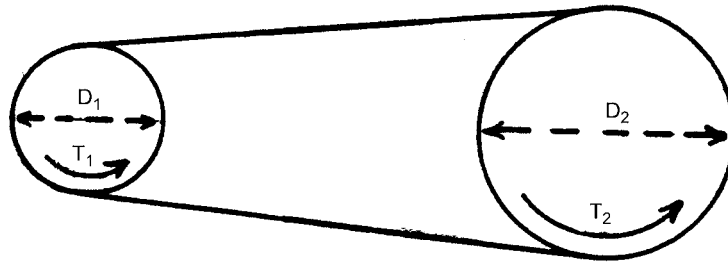

Figure 8:

**Example**

$D_1 = 10 \text{ cm}$

$D_2 = 15 \text{ cm}$

$T_1 = 1410 \text{ RPM}$

$$10 \times 1410 = 15 \times T_2 ; T_2 = 910 \text{ RPM}$$

To slow down  $T_2$  the pump requires a larger pulley.

For instance  $D_2 = 20 \text{ cm}$

$$10 \times 1410 = 20 \times T_2 ; T_2 = 705 \text{ RPM}$$

The pump continuously sucks air from the milking system. Its capacity must be such that the vacuum remains at a nearly constant level even when milking units are functioning.

The **positive displacement rotary pump** is quite common in milking machines; it is a robust pump and does not require much maintenance.

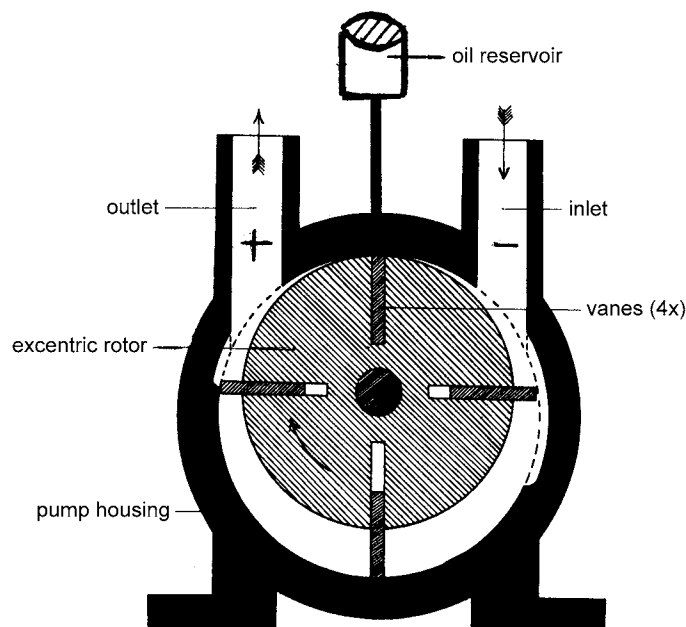

Figure 9:

The vanes are kept in contact with the casing by centrifugal force. When the rotor turns, pockets of air are caught between the vanes and transferred from inlet to outlet.

The vanes turn clockwise (very rapidly!).



## Lubrication

To prevent leakage of air from the inlet to the outlet, there must be a **film of oil** where the casing and the rotor are closest. Oil is also necessary to maintain an air seal at the rotor ends and around the vanes. And of course, oil reduces friction and disperses heat.

Two types of capillary lubricators are used with vane type rotary pumps, (a) the wick feed type and (b) the plate capillary type.

The wick type (a piece of cotton) is not common nowadays because the oil flow is difficult to adjust. With **plate capillary lubrication** it is possible to adjust the oil flow. For example:

- according to the operating manual the oil flow should be 5 ml/hour
- mark the oil level on the bottle
- record the operating period
- the oil level should fall by 1 mm each hour (when 10 cm corresponds with one half-litre of oil).

The oil flow can be adjusted by increasing (less oil) or decreasing the length of the adjustment pipe.

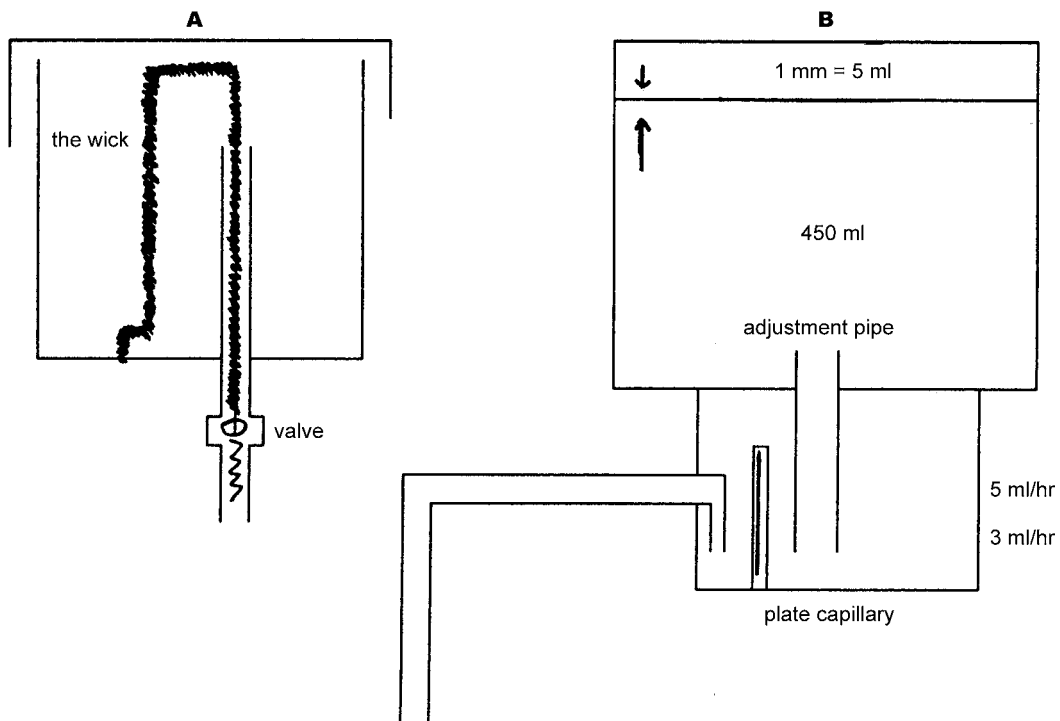

Figure 10:

A distinction should be made between oil that is **consumed** (in that case there should always be sufficient oil in the reservoir !) and oil that is **re-used** after filtration (that oil must be drained off and renewed after a certain number of working hours !).

When the pump is turned off, at least one tap in the air pipeline should be opened, in order to reduce reverse turning to a minimum. In some pumps, a one-way valve in the exhaust system does this automatically.

The **exhaust** (usually with silencer) from a pump that consumes oil should discharge outside the building. Ideally the exhaust system is short and slopes downwards from the pump.

Condensed water vapour and oil particles should not make the surroundings dirty. Often there is a device that separates the oil from the air that is expelled.

A **new development** is the use of the so-called **water ring pump** in which **water** is used for lubrication as well as for cooling and air-tightness. This pump is less noisy and there is no oil spilling (pollution!) but the price is higher and the pump consumes more energy.

### The capacity of the pump

The capacity of the vacuum pump is the amount of air (at atmospheric pressure) which is evacuated under working conditions (about 50 kPa) and at a given number of revolutions per minute of the pump. Capacity is expressed in litres of free air/minute.

In the Netherlands, there are certain norms as far as capacity is concerned, which should be taken into account when a milking machine is installed.

As the atmospheric pressure depends on the altitude, the pump capacity declines with increasing altitude.

When selecting a vacuum pump with a certain capacity this should be taken into account, as shown in the table.

*Table 1: Elevation correction factors to calculate the correct capacity of vacuum pumps at different heights*

elevation in metres above sea level	multiplier factor for needed pump capacity	normal atmospheric pressure in kPa
less than 300	1.00	100
300 - 700	1.07	95
700 - 1200	1.16	90
1200 - 1700	1.28	85
1700 - 2200	1.45	80

### Example

A milking plant situated at 1400 m above sea level has a corrected air demand of 450 L/min. Therefore the vacuum pump capacity at sea level should be  $450 \times 1.3 =$  about 600 L/min.

Buying a pump with a stated capacity of 450 L/min (manufacturer's specification) would be wrong in this case.

The capacity of a pump should be greater than the 'air consumption' of all parts combined if the vacuum is to be maintained at a certain level.

See following page for table.

*Table 2: Recommended minimum free air capacity of the vacuum pump in litres per minute at different numbers of units (source: IKC Lelystad)*

number of milking units	bucket type installation	milk pipeline installation (circulation cleaning)
2	250 litres/minute	330
3	300	
4	350	425
5	400	
6	530	675
8		1000
12		1400
16		1700
20		2000

#### 4.1.2 The air pipeline (vacuum pipe)

The air pipeline is connected to the pump. With an air pipeline it is possible to have 'vacuum' near the cows.

Air pipelines in milking installations are made of various materials. The material should resist corrosion and should not be attacked by anything inside the pipeline.

Quite often the air pipeline is a galvanized steel tube; the inside, too, should then be galvanized. The inner surface should be smooth, for rapid air displacement, and should have rounded bends. The pipeline should be easy to clean.

Sometimes PVC tubing is used; it gives less resistance to air flow, is easier to keep clean and does not corrode. But there are also certain disadvantages. One should be sure that it can withstand any internal pressure between 70 and 200 kPa, at all prevailing temperatures.

The vacuum pump removes air continuously. At certain places in the system there is **air admission** (milking units, pulsators). Air flows to the vacuum pump because of the pressure difference (where is the higher vacuum, at the vacuum pump or at the milking unit?). The pressure difference depends largely on the length and diameter of the pipeline. The greater the length and the smaller the diameter, the greater the vacuum drop. It is often specified that the pressure difference between the regulator and any place in the vacuum line should not exceed 2 kPa.

*Table 3: Standards for the minimum vacuum pipeline internal diameter in relation to the quantity of air extracted per minute at constant air flow; pipe length 30 m (source: IKC Lelystad)*

air flow in litres/minute	internal diameter (mm)	section surface area in cm <sup>2</sup>
less than 300	25 mm = 1 inch	5.0
200 - 600	38 mm = 1½'	11.3
600 - 1000	50 mm = 2'	20.4
1000 - 1700	63 mm = 2½'	31.2
over 1700	76 mm = 3'	45.3

Quite often, the pump is connected to the pipeline by a short piece of strong rubber tubing. This reduces vibration, which means less noise. It makes the removal of the pump easier and prevents electric current from accidentally reaching the pipeline. The placement should be vertical, in order to reduce the risk of the pump being fouled.

The air pipeline should not collect moisture. The pipeline should therefore be sloping towards the interceptor, about 1 cm per metre of pipe length.

If possible there should only be one end (i.e. no forking, away from the pump); this makes internal cleaning easier.

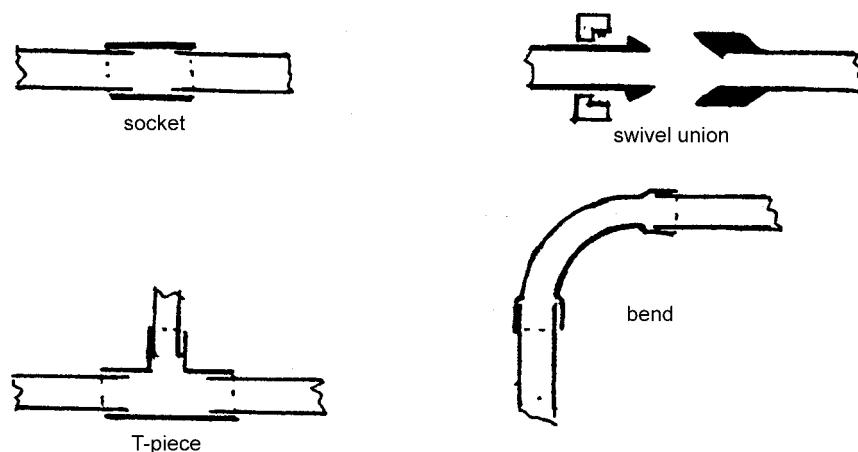

*Figure 11:*

The air pipeline includes the following associated components:

- interceptor
- vacuum regulator

- vacuum gauge (meter)
- vacuum taps
- drain valves

### 4.1.3 The interceptor

The vacuum pump is always protected by an interceptor (also called vacuum tank). Its main purpose is to stop fluids (water, cleaning solutions, accidentally milk) drawn through the air pipeline, from entering the pump and causing serious damage.

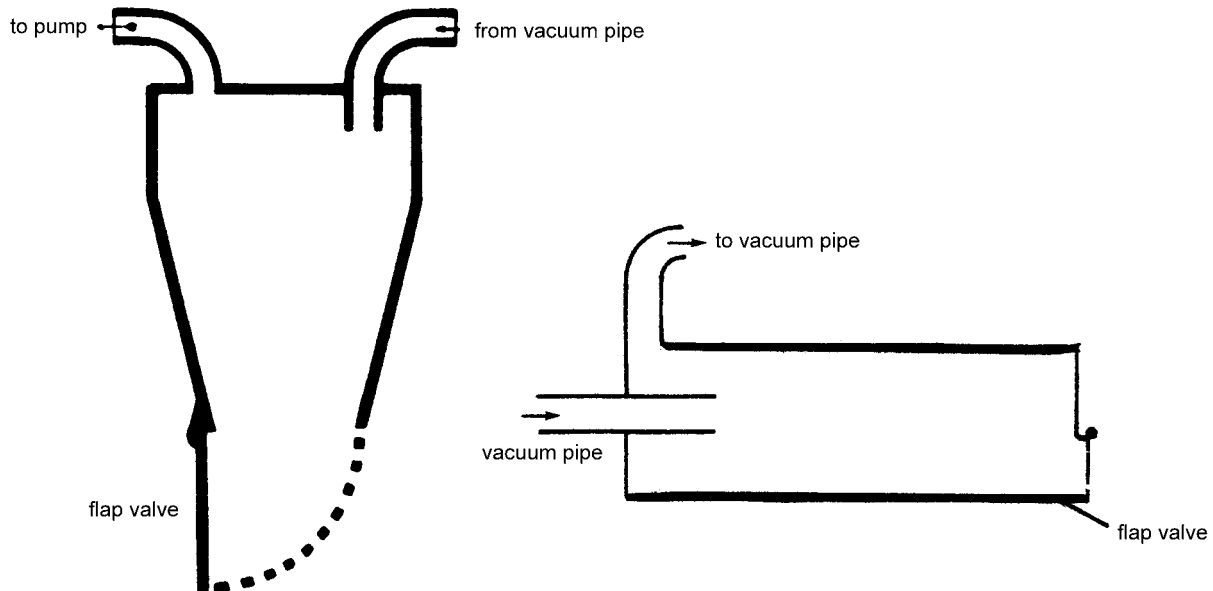

Figure 12:

There are several models on the market. Manual internal cleaning should be easy.

An incorporated float valve forms an additional precaution against flooding the pump.

Some interceptors have a self-sealing flap valve at the outlet, which opens automatically when the pump stops; any liquid that may have accumulated in the interceptor is then automatically discharged.

The interceptor should be installed close to the vacuum pump and should be easy to inspect and clean. Discharging liquid should not cause damage, for example to the electro-motor of the pump.

### 4.1.4 The vacuum regulator

The regulator should automatically maintain the vacuum at the desired level, notwithstanding a constantly changing 'air consumption' during milking. In other words, the amount of air entering the installation should be the same as that 'extracted' by the vacuum pump.

The regulator is pre-set at a certain vacuum level; when the internal pressure becomes too low, air is admitted automatically.

The regulator is fitted in the air pipeline, between the interceptor and the milking units. It should be accessible for cleaning and testing.

Sometimes it is fitted with a dust filter.

As for performance, when only one milking unit is functioning, the vacuum should not increase (= less pressure) by more than 2 kPa above the level obtained when all units are working.

There are three types of regulators:

- weight-operated regulator
  - valve rests on seat and supports a cast iron weight in a stable position
  - sometimes the weight is suspended from the valve instead of being supported by it
  - weight-operated regulators must be rigidly mounted (they depend on gravitational force) and as free from vibration as possible; they are not suitable for mobile milking machines

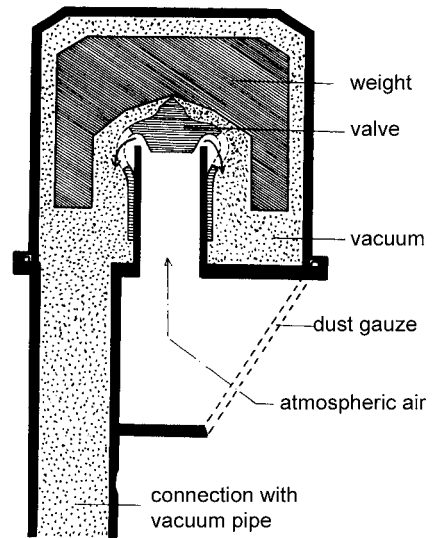
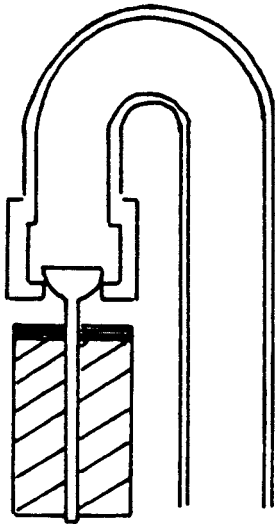

Figure 13: Weight-operated regulators

- spring-operated regulator
  - suitable for mobile milking machines
  - the tension of the spring determines the vacuum level

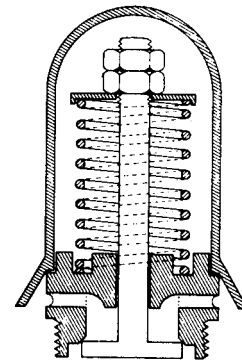
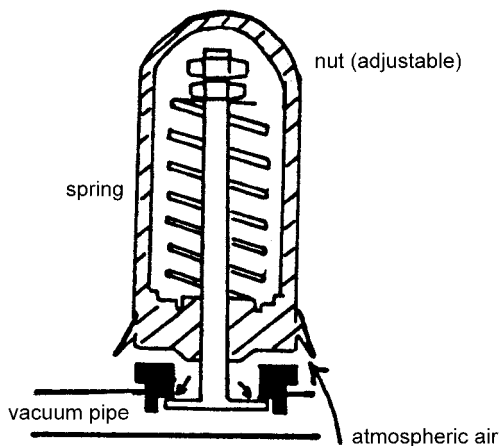

Figure 14: Spring-operated regulator

- sensor-operated regulator
  - the valve is connected to a membrane that is controlled by a vacuum-operated sensor
  - the sensor measures the vacuum level at a distance from the vacuum pump, where vacuum conditions are more stable than around the regulator valve; this is the reason for having a sensor-operated regulator.

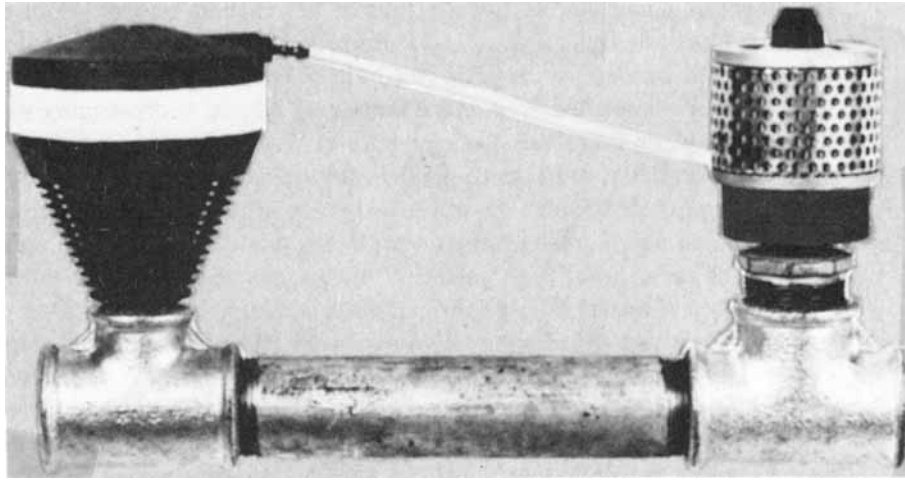

Figure 15: Photo of sensor-operated regulator

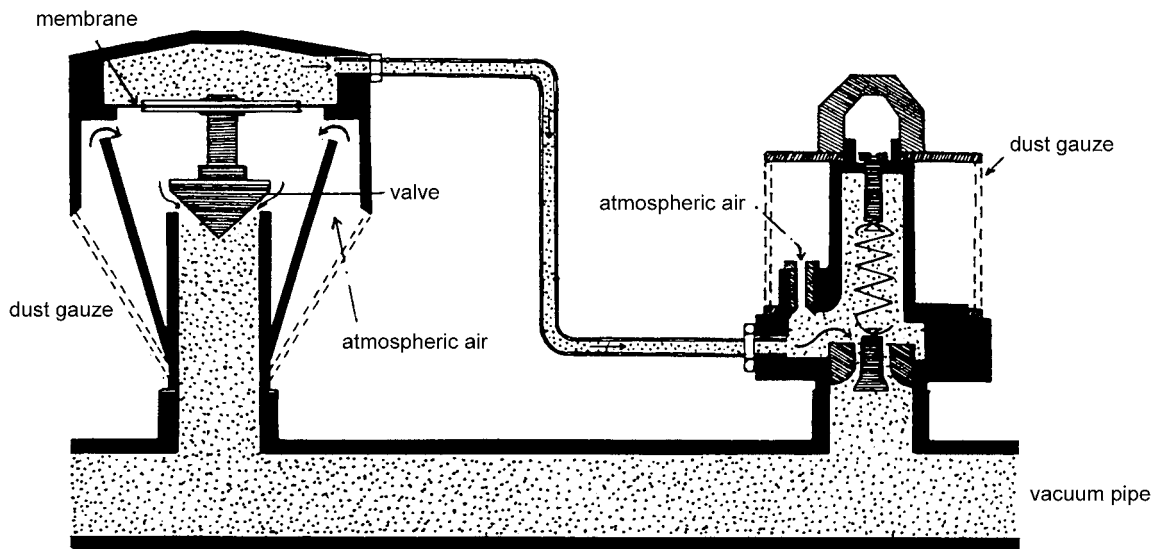

Figure 16: Cross-section of regulator with sensor

#### 4.1.5 The vacuum gauge (meter)

The gauge measures the pressure in the vacuum system. Its position should be such that it can be easily read by the milker. The diameter of the gauge should not be less than 75 mm.

In the past, gauges were usually calibrated in barometric units (0-30 inches Hg or 0-76 cm Hg) or in  $\text{kg}/\text{cm}^2$ .

Nowadays the SI units with scales 0-1 bar or 0-100 kPa are universally used (1 bar = 100kPa).

**Attention:**

'0' kPa on the scale of the vacuum meter means: there is air in the system, at atmospheric pressure.

'100' kPa means: the vacuum is complete, there is (absolutely) no air in the system. The higher the needle of the meter rises, the less air there is in the system. ('the vacuum increases'). For instance, at 50 kPa the vacuum is 'stronger' than at 40 kPa.

The normal operating vacuum should be at about half-scale and should be suitably marked on the scale.

Sometimes there is a locking screw, for transport purposes. Some gauges have a zero-adjustment fitted.



The vacuum meters installed in milking machines are not precision instruments, **even** when everything is in good working condition. The manufacturing tolerances are in the order of 2 kPa. The only reliable instrument for measuring the vacuum is a **mercury column** or a precision vacuum gauge.

Figure 17: Vacuum meter in kPa (and bar)

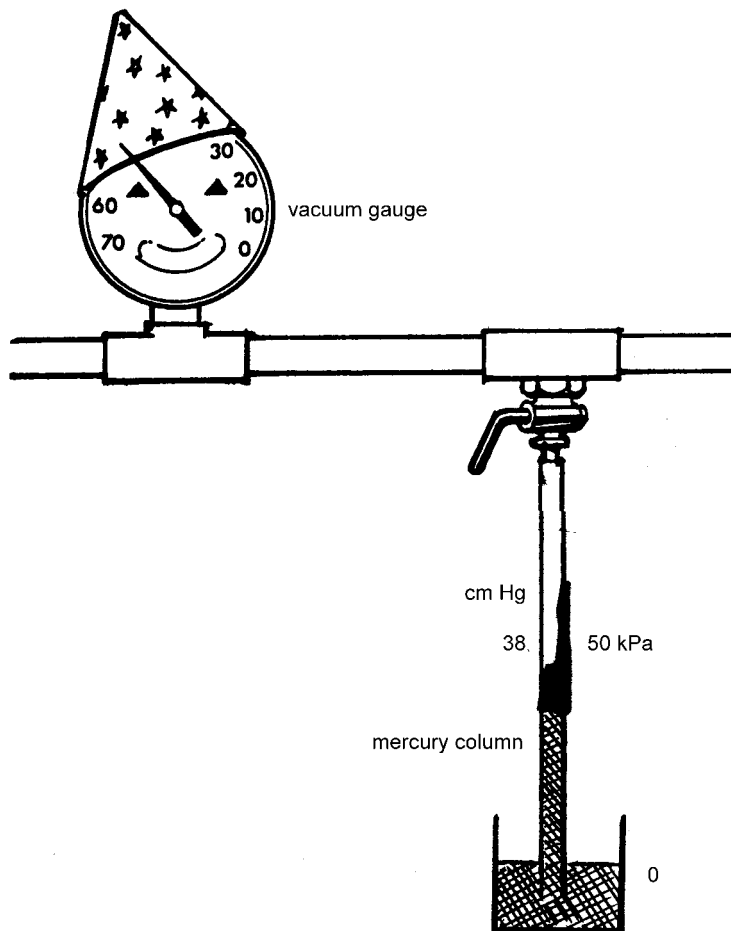

The illustration shows a (cheerful) vacuum meter of which the reading is checked by a mercury column. The latter gives a very precise reading (and is normally not present on a farm).

The vacuum is too strong (the needle has passed the '60' mark)  
– what is the reason?

The vacuum is too weak (the needle does not pass the '30' mark)  
– what is the reason?

Figure 18:

#### 4.1.6 Vacuum taps

Sometimes called stall cocks. They are used to connect the milking units with the air pipeline.

The connection should be made in the upper part of the air pipeline, so that moisture is prevented from draining down to the milking units as far as possible.

Sometimes there are stops, which should clearly show the difference between the fully open and the fully closed position.

In later designs it is no longer necessary to turn a tap manually. Simply pushing a rubber tube onto the nipple will apply vacuum to the milking unit. Pulling off the rubber tube seals off the vacuum.



Figure 19:

#### 4.1.7 Drain valves

Drain valves should be installed in the air pipeline at its lowest points. The liquid that is drained off should not trouble the cows. The valves should be opened at regular intervals.

Automatic drain valves are designed to close when the pipeline is under vacuum.

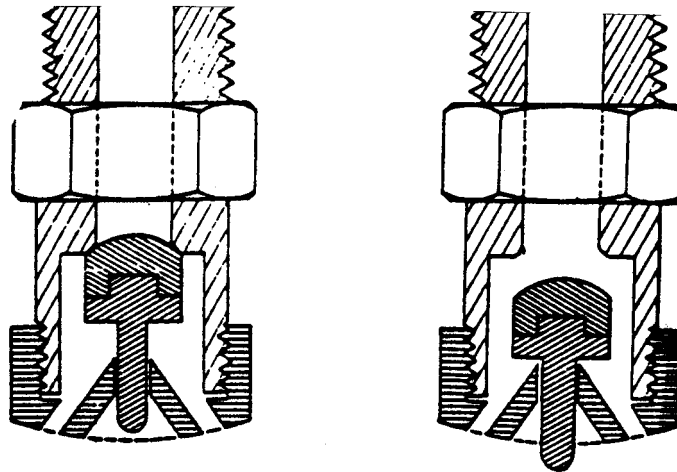
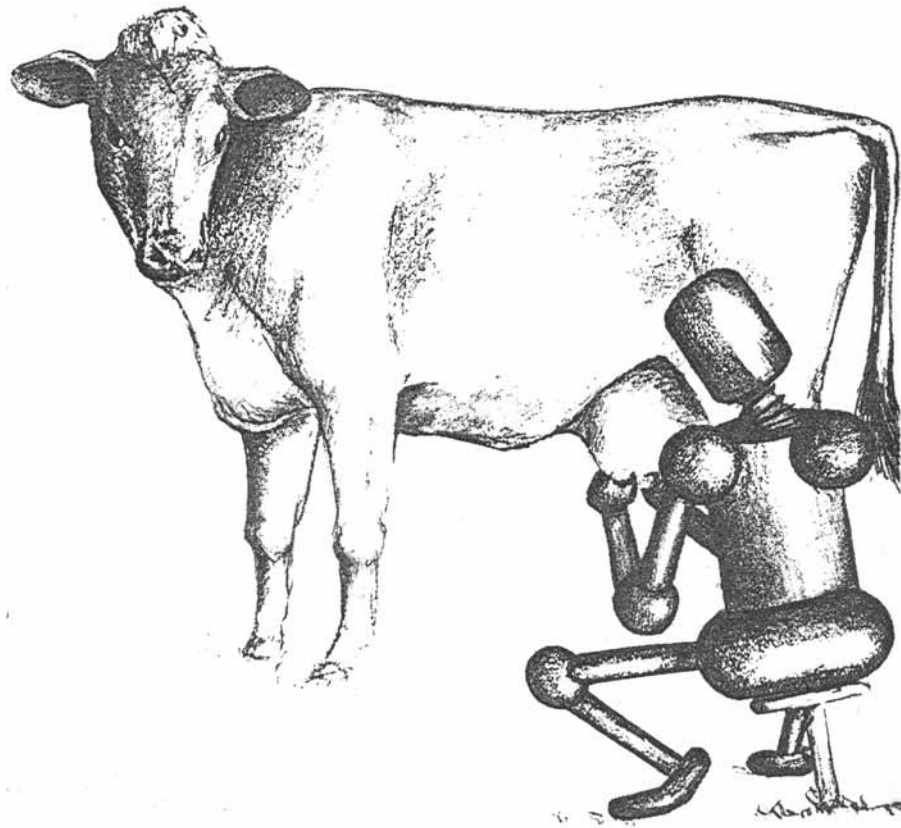

Figure 20:





*Figure 21: A robot as milker - will this become reality here and there? (see page 16)*

## **4.2 Milking units**

### **4.2.1 Various parts**

Milking units fall into **three** main classes:

- 1 milking units adapted to bucket or direct-to-can milking
- 2 milking units adapted to milking into recorder jars which empty into the milk pipeline
- 3 milking units adapted to milking directly into the milk pipeline.

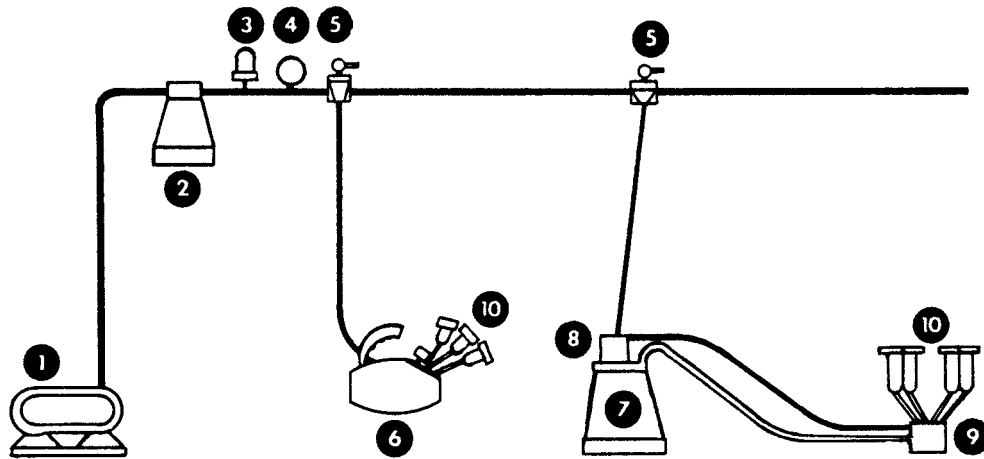

- |                  |                      |                      |                         |
|------------------|----------------------|----------------------|-------------------------|
| 1 = vacuum pump  | 5 = vacuum tap       | 9 = claw             | 13 = milk receiver      |
| 2 = interceptor  | 6 = suspended bucket | 10 = teat cups       | 14 = milk releaser pump |
| 3 = regulator    | 7 = standing bucket  | 11 = milk can        | 15 = three-way cock     |
| 4 = vacuum meter | 8 = pulsator         | 12 = overflow safety | 16 = milk recorder jar  |

Figure 22: Bucket milking

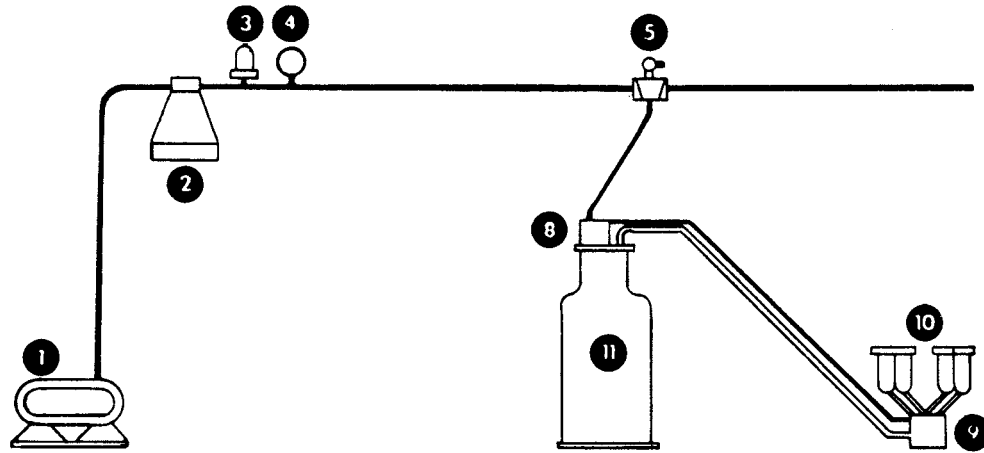

- |                  |                      |                      |                         |
|------------------|----------------------|----------------------|-------------------------|
| 1 = vacuum pump  | 5 = vacuum tap       | 9 = claw             | 13 = milk receiver      |
| 2 = interceptor  | 6 = suspended bucket | 10 = teat cups       | 14 = milk releaser pump |
| 3 = regulator    | 7 = standing bucket  | 11 = milk can        | 15 = three-way cock     |
| 4 = vacuum meter | 8 = pulsator         | 12 = overflow safety | 16 = milk recorder jar  |

Figure 23: Direct-to-can milking

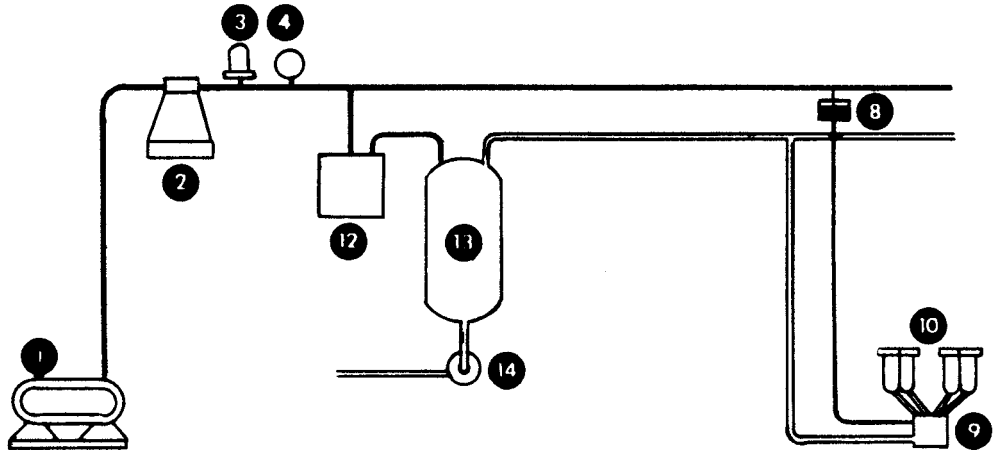

- |                  |                      |                      |                         |
|------------------|----------------------|----------------------|-------------------------|
| 1 = vacuum pump  | 5 = vacuum tap       | 9 = claw             | 13 = milk receiver      |
| 2 = interceptor  | 6 = suspended bucket | 10 = teat cups       | 14 = milk releaser pump |
| 3 = regulator    | 7 = standing bucket  | 11 = milk can        | 15 = three-way cock     |
| 4 = vacuum meter | 8 = pulsator         | 12 = overflow safety | 16 = milk recorder jar  |

Figure 24: Milk pipeline installation

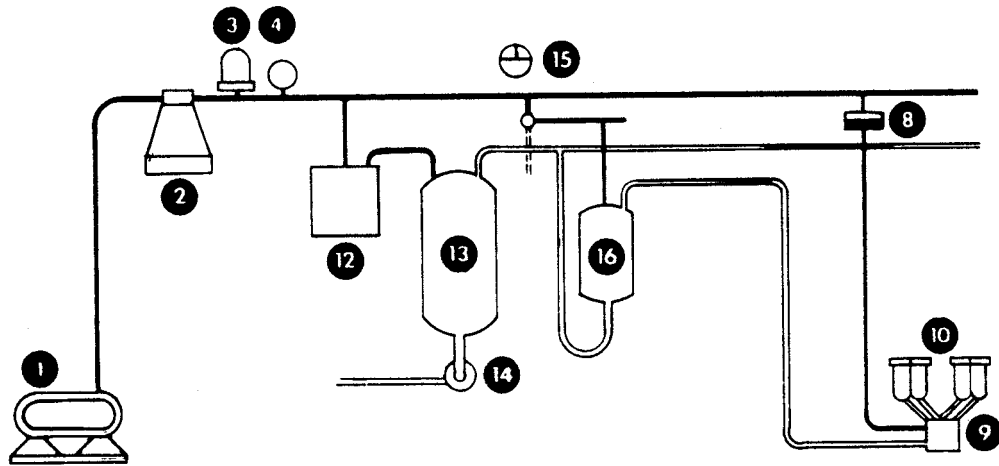

- |                  |                      |                      |                         |
|------------------|----------------------|----------------------|-------------------------|
| 1 = vacuum pump  | 5 = vacuum tap       | 9 = claw             | 13 = milk receiver      |
| 2 = interceptor  | 6 = suspended bucket | 10 = teat cups       | 14 = milk releaser pump |
| 3 = regulator    | 7 = standing bucket  | 11 = milk can        | 15 = three-way cock     |
| 4 = vacuum meter | 8 = pulsator         | 12 = overflow safety | 16 = milk recorder jar  |

Figure 25: With recorder jar

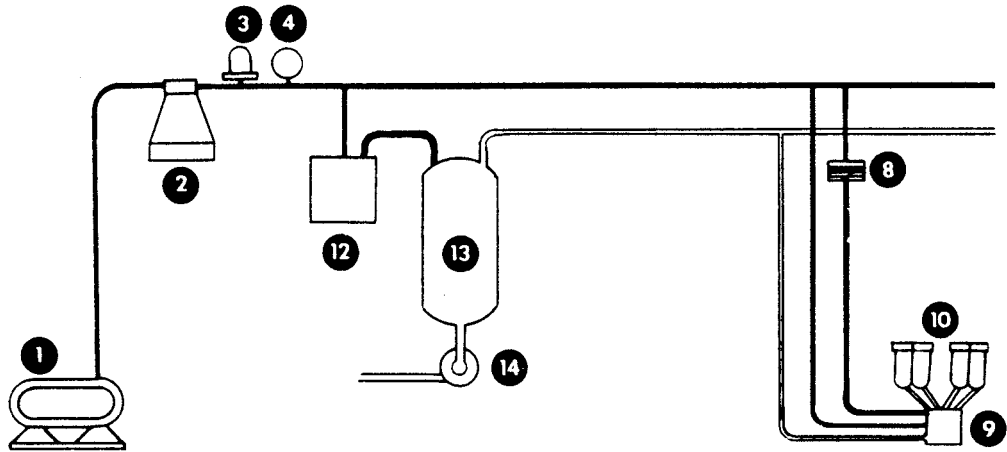

- |                  |                      |                      |                         |
|------------------|----------------------|----------------------|-------------------------|
| 1 = vacuum pump  | 5 = vacuum tap       | 9 = claw             | 13 = milk receiver      |
| 2 = interceptor  | 6 = suspended bucket | 10 = teat cups       | 14 = milk releaser pump |
| 3 = regulator    | 7 = standing bucket  | 11 = milk can        | 15 = three-way cock     |
| 4 = vacuum meter | 8 = pulsator         | 12 = overflow safety | 16 = milk recorder jar  |

Figure 26: With separate transport of air and milk

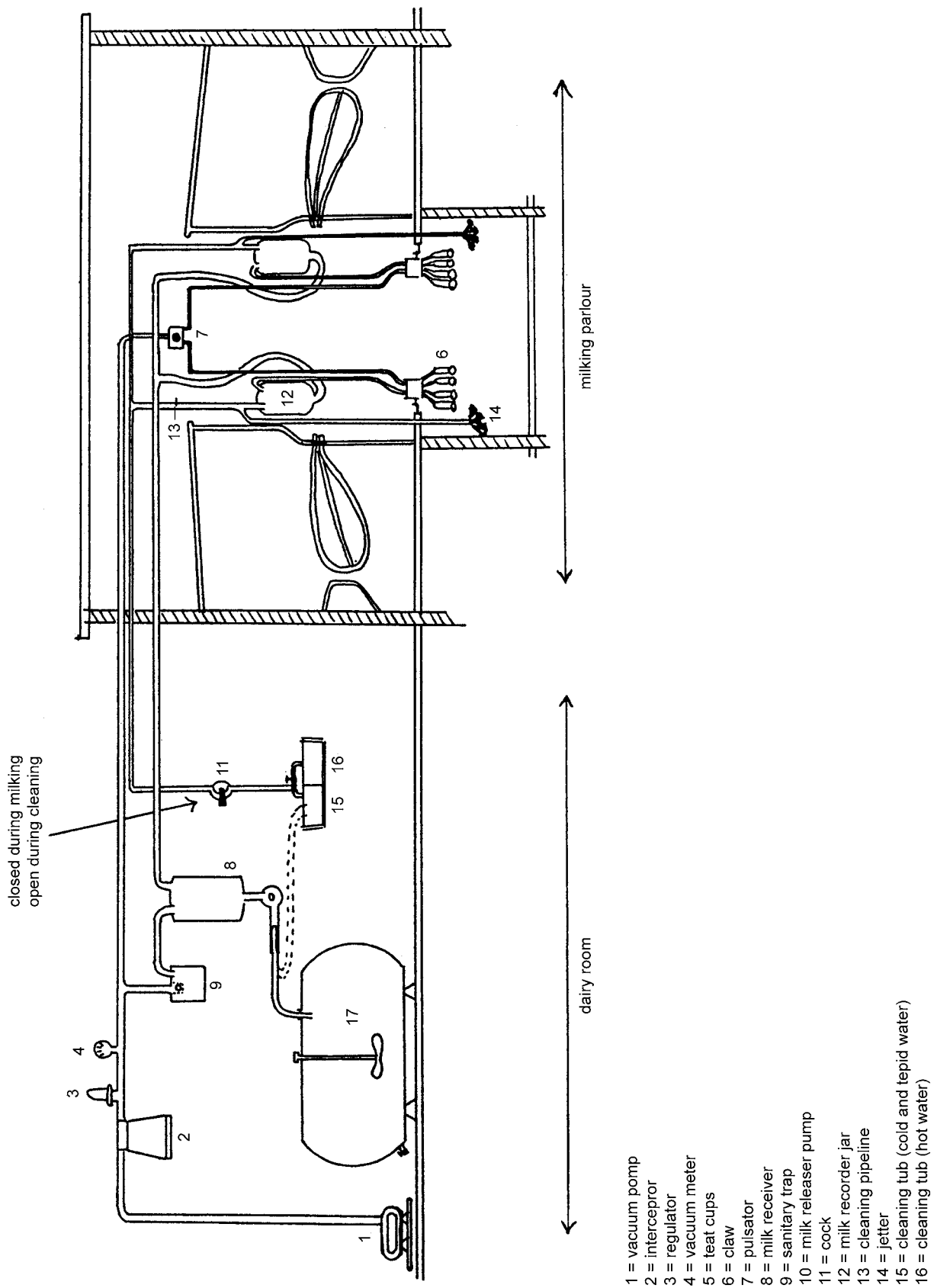

Figure 27: Milk pipeline system with milk recorder jars in the parlour

In the **standing bucket type** milking unit, the long milk tube forms the connection between the bucket and the milk chamber of the milk claw.

The long pulsation tube (or tubes) forms the connection between the pulsator and the air manifold part of the milk claw.

The four **teat cups** are placed on the milk claw; each teat cup consists of:

- a metal teat cup **shell** (normally stainless steel)
- a **rubber liner** (synthetic rubber or a mixture); it is a flexible sleeve, with what is called a mouth-piece and a barrel.

The liner should

- provide an air-tight joint at both ends of the shell
- provide a mouthpiece that fits well onto the teat, in order to prevent air admission into the milking system as far as possible
- be reasonably easy to clean
- milk the udder as completely as possible.

The liner is a very important part of the milking machine installation !

The short milk tube forms the connection between the space below the teat and the milk chamber of the claw.

The short pulsation tube connects the pulsation chamber to the air manifold part of the claw.

The (milk)**claw** connects the different tubes. Using simultaneous pulsation, there is only one long pulsation tube nipple on the claw.

The assembly of ‘teat cups’ with their short tubes, the claw and the long tubes is called a **cluster**.

The four short milk tube nipples on the claw are normally set at an angle; consequently when the assembly is held ready, the teat cups will hang downwards and seal off the short milk tubes by their own weight.

The volume of the milk chamber of the claw varies; the average is about 85 ml. Normally air can enter the milk chamber when milking is in operation (slot or hole).

The milking bucket (or the milk can) has a **lid assembly**, to which the cluster is attached.

The lid must be strong enough to withstand the vacuum to which the bucket is submitted. Usually lids are made of stainless steel; a thick rubber gasket must seal the lid to the bucket.

The lid has connections in order to admit milk and allow air to escape:

- The **milk inlet** may have a cock to isolate the teat cups from the vacuum, and a sight glass. However, their presence makes cleaning more difficult and it is probably better to cut off the vacuum by kinking the long milk tube, or by turning a valve in the claw. A pinch clip fitted to the long milk tube will also suffice.
- The **vacuum connection** usually has some kind of non-return valve, in order to maintain a proper vacuum level in the bucket, if a temporary and substantial vacuum drop in the pipeline occurs. It is **not** a ‘moisture trap’ to prevent contaminated moisture from the vacuum from reaching the bucket, as is sometimes said. That is a question of correct installation, maintenance and daily cleaning.

Normally the lid has an attachment for the **pulsator**. If the pulsator requires a vacuum for its operation, this vacuum is not taken from the bucket, but is taken separately from the air pipeline; in this way contaminated air from the pulsator does not enter the bucket directly.

Normally the pulsator is easy to remove, thus making cleaning of the other lid assembly parts easier.

## 4.2.2 Pulsation

When the milking machine is working, the pulsation chamber of a teat cup is alternately connected to the vacuum and to free air (atmospheric pressure) by the action of **the pulsator**.

What happens can best be understood by studying the following illustration.

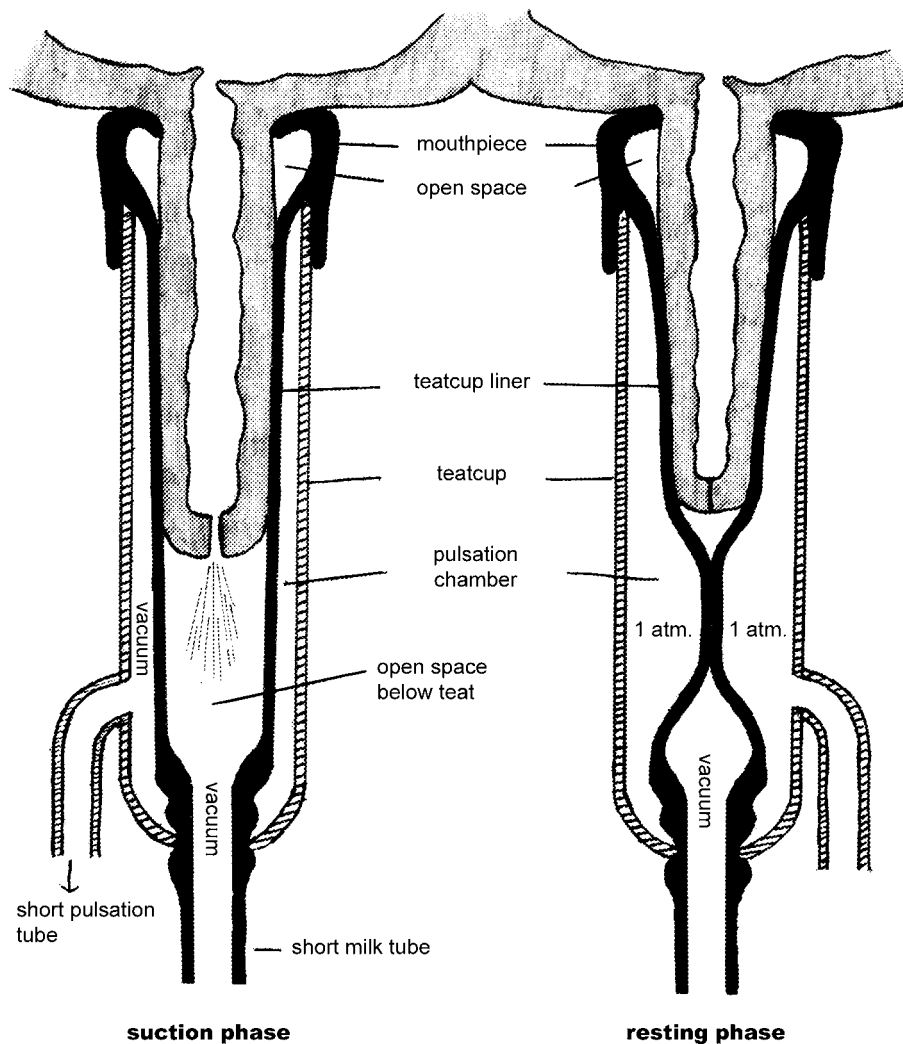

Figure 28:

During the **suction phase**, there is vacuum on both sides of the liner (milk chamber and pulsation chamber); the liner is open:

- the teat is stretched lengthwise and widened
- the muscle that closes the teat is counteracted
- the teat opens
- the milk is sucked out of the teat.

During the **resting phase**, there is vacuum in the milk chamber and atmospheric pressure in the pulsation chamber (due to air admittance); the liner is closed:

- the teat is no longer being stretched
- blood circulation in the teat is restored to normal.

One suction phase and one resting phase together form **one cycle** (pulsation). The number of cycles per minute is called the **pulsation rate**.

The changes of pressure in the pulsation chamber are represented in the following graph:

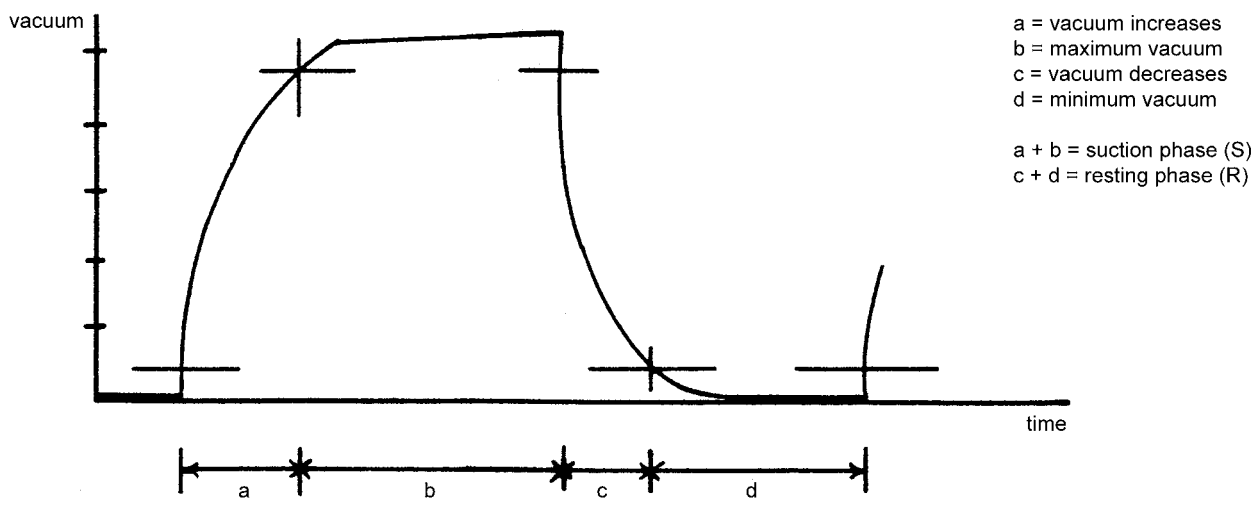

Figure 29: Pressure changes in the pulsation chamber of the teat cup

The number of pulsations per minute is the **pulsation rate**. It should be 50-60 per minute, but partially depends on the pulsation **ratio** (see below).

The pulsation **ratio** indicates the proportionate duration of S and R. In some milking machines the suction phase lasts as long as the resting phase; the pulsation ratio is then 50:50. Usually the suction is longer; the ratio may then be 60:40, for example. Some more figures, by way of illustration, are given below.

Table 4: Pulsation rate is 50 (number of pulsations per minute)

S : R	in% of total cycle duration				in 1/100th seconds			
	a	b	c	d	a	b	c	d
50:50	20	30	20	30	24	36	24	36
60:40	20	40	20	20	24	48	24	24
70:30	20	50	20	10	24	60	24	12

When the ratio rises (i.e. a relatively longer suction period), the milk flow will increase but there is a risk of teat congestion (poor blood circulation). When the ratio drops, there will be more ‘massage’ but the milking may take too much time. It is very important to avoid both teat congestion and milking that takes too long.

**Pulsators**

For milking, the pulsation chamber of the teat cup must alternately be connected with the vacuum and free air (atmosphere). This is ensured by the action of the **pulsator**.

The pulsator is connected to free air, the vacuum and the pulsation chambers. A valve - in the form of a disc, slide or piston -has two positions with regard to these three connections, resulting in either

- a connection between free air and pulsation chamber
- a connection between vacuum and pulsation chamber



This is illustrated as follows:

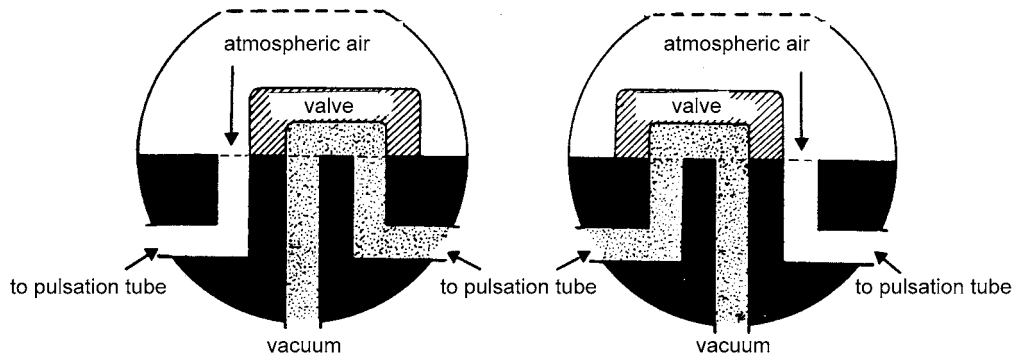

Figure 30:

The suction and resting phases may be simultaneous in all four teat cups. This is called **simultaneous pulsation**. In that case there is only one pulsation tube.

In other machines, two teats may be in the suction phase, while the other two are in the resting phase. This is called **alternate pulsation**; it requires two pulsation tubes.

Pulsators may be classed as (a) **pneumatically** controlled or (b) **electrically** controlled.

In each of the two types there are self-contained pulsators and pulsators which are controlled by a central pulsator which regulates the pulsation rate and ratio.

### **pneumatic pulsators**

Each milking unit may have a (self-contained) pulsator connected to the vacuum pipe. Free (atmospheric) air can also enter into the pulsator.

In the long run, the sealing properties of the pistons or membranes will deteriorate; they must then be replaced.

Whatever the construction may be, all pneumatic pulsators should be kept clean internally. Therefore they all have a dust filter, which must periodically be cleaned or replaced.

Milk may also contaminate the pulsator, for example if a bucket is overturned or overflows; this must be thoroughly cleaned up after milking.

### **electric pulsation**

This needs direct current of 12 or 24 Volt. The source may be:

- normal electric power which is transformed and rectified
- a dynamo driven by the motor of the milking machine

If the interruption of the electric current takes place centrally, this means that all milking units operate at the same pulsation rate.

Often there are **pulsation strengtheners**.

Electric pulsators may all work simultaneously (at the same time). This may cause disturbing vacuum drops in the vacuum pipeline.

A better system is the **cascade** system, in which the pulsators in a milking plant operate in 2 or 3 groups. This leads to more regular 'air consumption'.

In modern milking plants, with several milking units, it is common practice to use **electric pulsators**, because they

- are cheap and reliable
- require little maintenance
- maintain a set pulsation rate and ratio

In case of failure, however, few local mechanics can repair such pulsators. But it is usually easy to fit new parts.

## 5 Milk transport and milk flows on the farm

Milk can be carried in buckets to the farm dairy room, by the milker or by another person. This is still widely practised on farms where milking is done by hand or where a bucket milking machine is in use.

Walking is greatly reduced when the milk is poured into transport cans that are mounted on a cart.

In more advanced milking systems, there is a **milk pipeline** around the cowshed, with **two** functions: applying vacuum to the cows' teats and transporting milk to the **receiver** installed in the dairy room, under vacuum conditions. In that case, buckets are no longer necessary.

### 5.1 The milk pipeline and the receiver

The milk pipeline transports the milk to the **milk receiver** (glass). The receiver separates milk and air from each other. It has a **sanitary trap** and an electrically driven **milk releaser pump** which extracts milk from the receiver (which is under vacuum) and transports it to the **cooling tank**. The pump is usually of the centrifugal type. A **milk filter** is usually mounted in the pipeline between the receiver and the tank; this filter needs regular attention.

Normally the receiver has **four** connections.

Two of them (in the case of a double connection, which reduces the milk transport distance) are for the **milk pipeline** and are usually fitted near the top of the receiver.

The connection to the **vacuum pipeline** is at the top; it is fitted with an overflow safety device. The overflow safety has a float which blocks the vacuum-receiver connection when the milk level in the receiver is in danger of rising above a pre-set level. The bottom of the receiver is connected to the **milk releaser pump**.

There are certain recommendations with regard to the milk pipeline:

- normally it is made of stainless steel, with smooth interior surfaces
- the diameter of the line must be related to the quantity of milk that has to be transported and to the length of the line
- the pressure difference in the line should not exceed 2 kPa; the line should never become 'blocked' by milk; air should be able to pass freely, at all times
- the line should slope slightly downwards, to the receiver ( $\frac{1}{2}$  to  $1\frac{1}{2}\%$ ).
  - there should be no elevations in the line; elevations cause vacuum decreases (variations) and are harmful to the milkfats
  - if an elevation is necessary from a construction point of view, this should be (temporarily) eliminated when the line is used for milking.

Table 5: Recommendations for the maximum number of units on milk pipelines of different internal diameters for an average milk production of 15 kg per milking (source: IKC Lelystad)

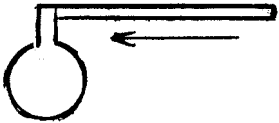
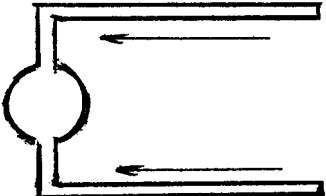
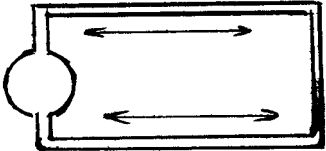
type of milking pipeline	internal diameter in millimetres and inches	total length in metres of the milk pipeline			
		10	20	30	50
 Single milk pipeline (dead end)	32 (1¼')	2	-	-	-
	38 (1½')	3	2	-	-
	51 (2')	6	4	3	2
	63 (2½')	-	6	5	4
	76 (3')	-	10	8	6
 Double milk pipeline (dead ends)	32 (1¼')	4	-	-	-
	38 (1½')	6	4	-	-
	51 (2')	12	8	6	4
	63 (2½')	-	12	10	8
	76 (3')	-	20	16	12
 Circuit (looped) milk pipeline	32 (1¼')	-	5	4	3
	38 (1½')	-	7	5	4
	51 (2')	-	12	10	7
	63 (2½')	-	-	14	12
	76 (3')	-	-	-	-

## 5.2 The milk releaser pump

The pump should be easy to dismantle for inspection and servicing. It should have a drain tap either in the pump body or in the outlet pipe.

The pump is automatically switched on and off by a control device, so that the pump starts to work when the milk in the receiver rises to a pre-set level and is switched off when the receiver is nearly empty.

The reasons for not completely emptying the receiver are to keep the pump primed and to avoid excessive aeration of the milk; this has a negative effect on milk quality.

Normally the above control device has an overriding switch which can make the pump run continuously, for complete milk evacuation and for circulation cleaning.

The control device may consist of:

- a set of electric probes, usually three
- an electro-magnetic float switch
- a weight-operated switch (becoming obsolete)

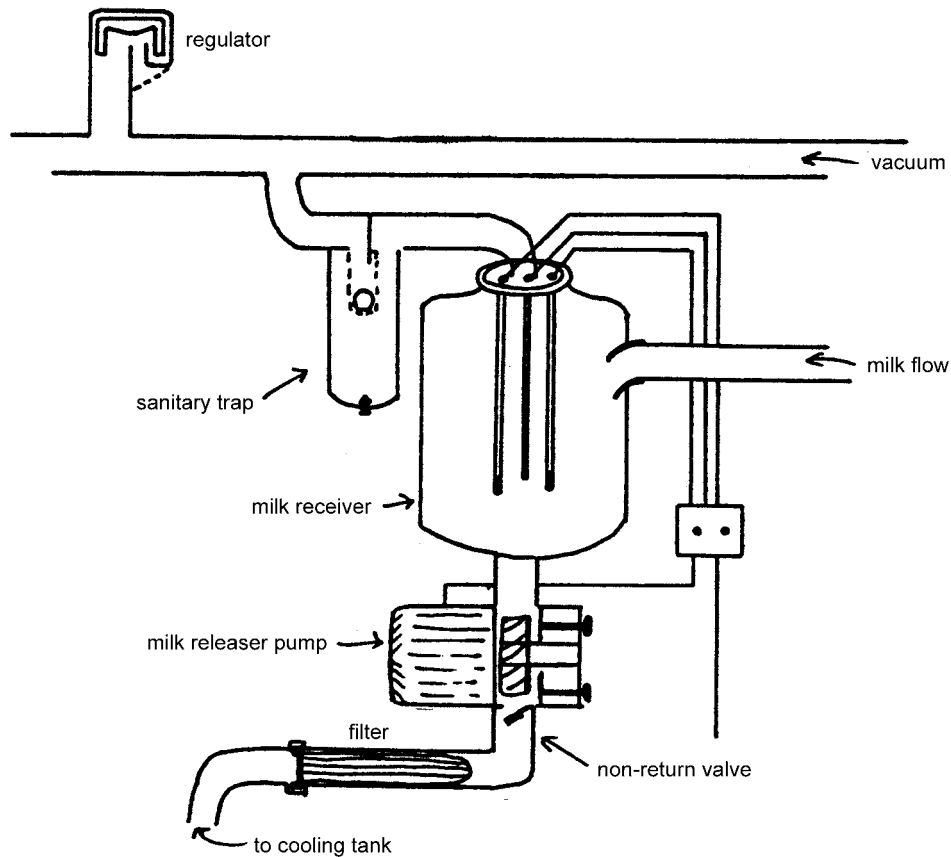

Figure 31: Milk receiver with electric probes

Excessive foam formation in the milk receiver should be avoided at all times.

Excessive foam leads to 'blind turning' of the milk releaser pump, which causes the formation of free fatty acids in the milk (loss of quality).

### 5.3 Stand-by equipment

Given the fact that **milking should never be interrupted**, which means that the milking machine should always be operational, it is necessary to have stand-by equipment in order to have an alternative drive for the vacuum pump and to have electric current for lighting purposes, the electric pulsation, the milk pump of the receiver and for cooling.

As far as **vacuum pumping capacity** is concerned, there are two proven ways of ensuring continuity in the case of an electric power failure. These are outlined below.

#### Using a stationary engine

Either a petrol or a diesel engine can be used. The engine should be fitted to run a V-belt, and it should be easy to put this engine into a pre-set position from which it can drive the vacuum pump pulley.

This stand-by engine must be well maintained and should run from time to time in order to ensure reliability.

#### Using a tractor power take-off (p.t.o.)

In this case the vacuum pump is driven from a tractor p.t.o.; it requires a special drive that fits the vacuum pump of the milking machine.

The required equipment is quite cheap and hardly needs maintenance, but the tractor must be able to be brought into position.

The tractor is also a reliable source of 12 V d.c., for powering essential electrical equipment such as the electro-magnetic pulsator.

One more illustration, to conclude this chapter:

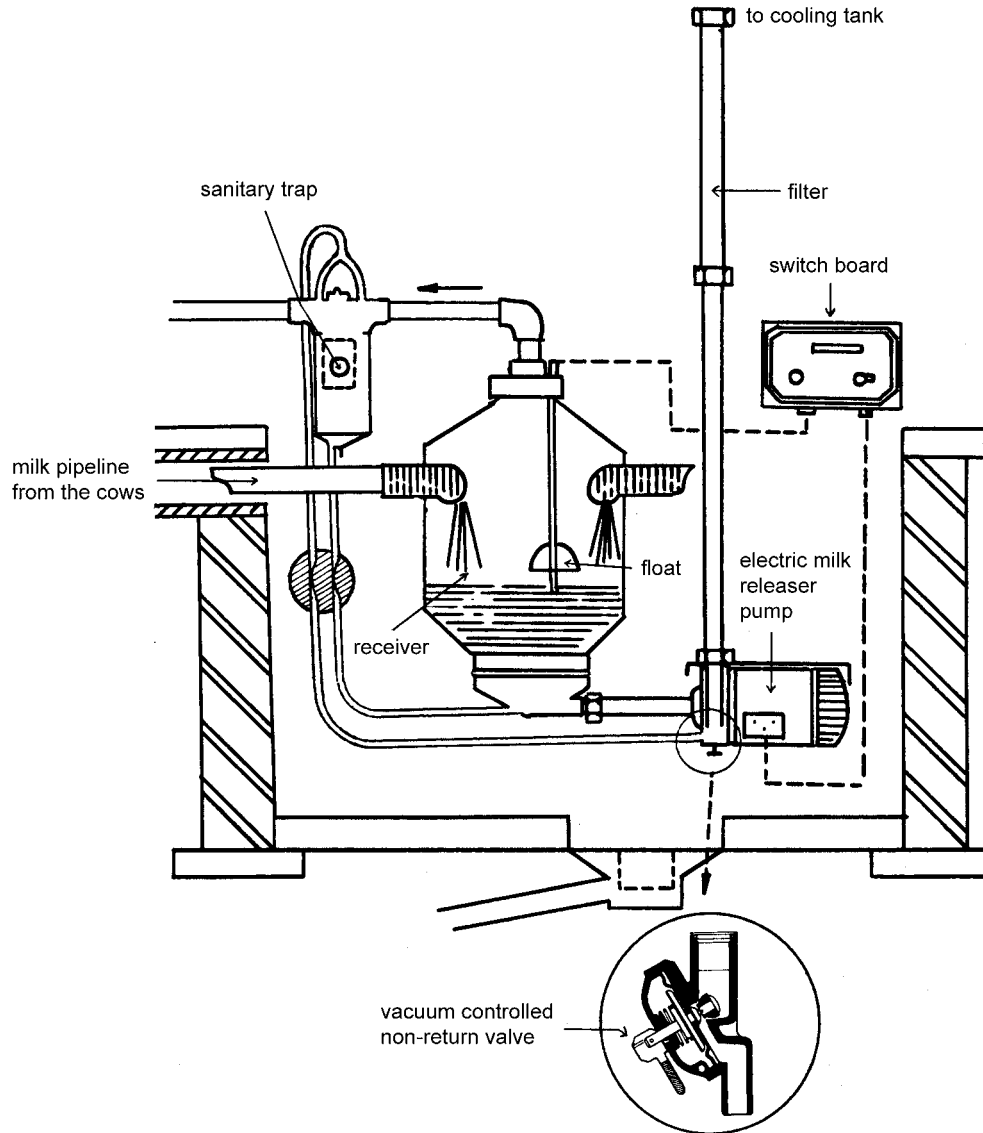

Figure 32: Schematic representation of milk reception in the dairy room (milk pipeline system)

## 6 Machine milking

With machine milking, various methods and techniques can all lead to equally good results with regard to milk yield, milk quality and udder health.

Apart from this, the efficient use of the milking units and the available labour is also important. The order in which the various routine operations have to be carried out in order to get a high labour output (number of cows milked per man per hour) is not always ideal with regard to other characteristics of good milking. A good milking routine may sometimes be a compromise between highest yield/quality and labour output.

In milking, two situations can be distinguished:

- 1 The cows are **standing in a row** (cowshed milking); bucket milking **or** pipeline milking can be applied
  - milk the cows from left to right
  - it is handy to place fast-milking cows at the beginning of the row and/or at the end; cows requiring special attention (time !) should be placed in a position where time is available
  - with a large herd and two competent milkers it is better to divide the cows into two groups, each group being milked by one milker. This is better than operating together (working efficiency, possible misunderstandings and individual responsibility).
- 2 **Parlour milking**; the cows come to the milker and a fixed order of milking is impossible for this reason

Another differentiation in machine milking is the following:

- 1 **Bucket milking** (cowshed)
- 2 **Pipeline milking** (cowshed or parlour)

These basic routines have various applications.

In the following section 'P' stands for (number of) persons (milkers), 'U' stands for (number of) milking units handled per person.

### **Bucket milking**

The bucket plant is the most simple type of milking installation. It consists of:

- at least one bucket unit (cluster, pulsator, bucket, long pulse tube, long milk tube, vacuum tube)
- a vacuum unit (pump, motor, vacuum tank)
- a vacuum line to the stall, with taps
- a vacuum regulator
- a vacuum gauge.

The milk flows straight from the cluster through the long milk tube to the bucket. The bucket has a capacity of about 20 litres and temporarily stores milk from one or two cows. When the bucket is full, the vacuum has to be released and the bucket emptied.

Bucket milking is normally used with small herds (tied cows) and with newly calved cows irrespective of the size of the herd and the type of housing.

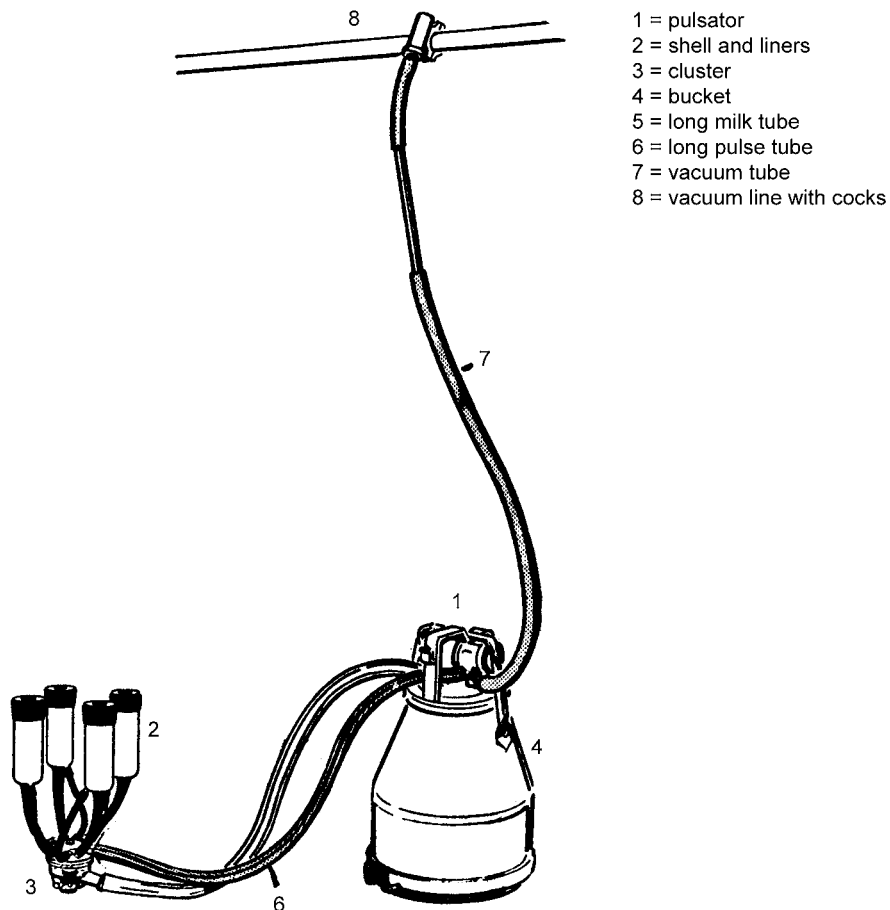

Figure 33:

### Pipeline milking

Partly in order to avoid the tedious and repetitive work of changing and emptying buckets, many farmers prefer a pipeline installation when feasible.

Such an installation makes milking less tedious and more rapid (output per operator).

A pipeline system consists of:

- milking unit (cluster, pulsator, long pulse tube, long milk tube, vacuum tube)
- vacuum unit (pump, motor, vacuum tank, vacuum line to the cow's stall, vacuum taps, vacuum regulator, vacuum gauge)
- milk pipeline
- an end unit, with or without a milk pump.

The milk is drawn from the cluster through the long milk tube into the pipeline, in which it flows to the end unit from where it is normally pumped into the milk tank.

Complete line machines are a necessity if one wants to obtain good results. In pipeline plants sometimes up to 4 units per person can be handled, in early lactation.

In parlour milking the cows are sometimes fed a little (very palatable) concentrate. This stimulates milk ejection and may be as 'powerful' as 'sham milking' (about 30 seconds massage of teats with full fist). Concentrate feeding may also induce the cows to enter the parlour relatively quickly. But it may make the cows restless before and during milking, which in itself is a sign that it works!

Other 'stimulants' than concentrate feeding and 'sham milking' are:

- udder and teat cleaning;



- foremilk checking;
- the normal massage of the teats by the rubber teat liners during actual machine milking;
- some modern milking machines have a special ‘massage phase’ in the milking process;
- a (very) high vacuum in itself also has a stimulating effect
- (hand) stripping after milking

The normal massage by the teat liners during actual milking is not stimulating enough for maximum milk ejection; for that reason something **extra** is required (listed above).

Insufficient oxytocin release may also be a question of not applying the stimulus **at the right time**: udder preparation taking place too early or concentrate feeding too long before actual milking takes place.

Milk ejection may then be (partly) delayed; after milking stripping by hand may induce a second ‘let down’. The total milk yield may thus be in order, but milking takes (a lot of) extra time. Cows easily get used to this situation! and the milker should not let this happen.

If concentrate feeding is not possible or not desirable, the best preparation for machine milking seems to be ‘sham milking’. Admittedly this takes time, but stripping by hand is then no longer necessary.

The time between udder preparation resulting in ‘let down’ and actual milking should be as short as possible; waiting times longer than 2 minutes decrease milk production markedly (unless stripping is applied, 2nd let-down). Cow ‘preparation’ before a milking unit is actually available should be avoided, especially when the length of this so-called first waiting time is variable.

### **Ending the milking in pipeline milking**

The timing and the technique of stopping (removal of the teat cups) are tricky. Towards the end of the milking there is normally a quite sudden change from ‘high milk flow’ to ‘low flow’. This could be called the beginning of so-called ‘blind milking’ or over-milking; there is still milk in the udder. It would appear that about two minutes of ‘blind milking’ does no harm, on the contrary, it appears to have a positive effect on cell count and udder health. A long(er) period of blind milking should normally be avoided, however.

With **automatic teat cup removal** the responsibility of timing the removal no longer rests with the milker, which is an advantage. Normally the automatic removal is set at a milk flow of 0.2 kg/minute. Keep in mind that this setting is arbitrary, but in practice it proves to be satisfactory.

The **non-automatic removal** of teat cups should be done with great care. Sudden removal may result in ‘impacts’: strong air pressure changes which ‘shoot’ (infected) milk droplets back into the teat canal (risk of mastitis).

The best way of machine-stripping is probably by pushing the milk claw into the right position for some time.

If there is no machine stripping, wait some time after the vacuum has been cut off before removing the teat cups, so that the vacuum under the teats falls away gradually (no sudden strong air pressure changes around the teats).

It should be noted that the above recommendations are based on experiments carried out in Western Europe (Holland, UK). Under other conditions these recommendations may not be so valid and others may need to be added. However, dairy cows have a tendency to become the same everywhere, and milking machines are ‘universal’ already.

Using a pipeline plant, P1U3 gives an output of 25 to 40 cows per person per hour. Using buckets, an output of 25 to 35 cows can be obtained.

### Milking routine with buckets or pipeline milking

Often one person milks cows in a tying-up stable with buckets or with 2 or 3 units and a milk pipeline.

**Example:** one milker with two buckets

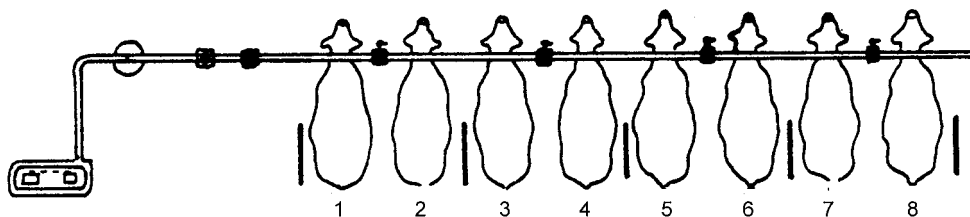

Figure 34:

#### working order:

- 1 go to cow nr.1 with bucket nr.1
- 2 prepare udder of cow.nr.1
- 3 put teat cups on to cow nr.1
- 4 take bucket nr.2 and go to cow nr.3
- 5 prepare the udder of cow nr.3
- 6 put teat cups on to cow nr.3
- 7 go back to cow nr.1 and feel with two hands in the lower part of the udder if there is any milk left in the udder cistern
- 8 take off the teat cups of cow nr.1
- 9 empty the bucket if necessary
- 10 check the udder of cow. nr.3
- 11 go to cow nr.2
- 12 prepare the udder of cow nr.2
- 13 put teat cups on to cow nr.2
- 14 go to cow nr. 4; etc.

### Milking routines in parlours

Cleaning the udder, taking the foremilk, and putting on the cups in one operation, is not so difficult.

In rotating parlours, putting on the cups immediately after cleaning is a necessity, for the sake of work efficiency.

In parlours with one unit for two stalls, the lapse of time between udder preparation and actual milking may cause a problem.

While the cows are milked in one part of the parlour (a 'herringbone' parlour) the animals in the other part are prepared for milking. The lapse of time between preparation and actual milking may increase to 5 minutes or more, at least when machine stripping is practised. In view of the desirable complete milk ejection, these long waiting times have to be avoided. Having one unit for each stall seems to be the answer.

With an increasing number of units per person the risk of overmilking becomes greater. Slight overmilking does not harm udder health, but excessive overmilking must be avoided.

Indicators (pointer, light or eye glass) may be helpful in preventing excessive overmilking. However, a good milker removes the clusters without the aid of indicators and thus limits overmilking.

When the indicator produces an electric signal, this signal can be used for automatic teat cup removal.

### Milk flow indicators

In parlour milking there is usually some provision for seeing whether the milk flow from an udder is coming to an end or has stopped.

Often this is in the form of transparent components or insertions, such as glass transition pieces joining the liners to the milk tubes, transparent covers on claw bowls and or short lengths of transparent tube inserted into long milk tubes.

Usually these provisions do not give an instant clear indication of the state of milk flow because of lighting problems and the obscuring of the transparent surface by a film of milk.

Transparent areas with a larger surface are much more useful, while **recorder jars** are entirely satisfactory.

### The recorder jar

In parlour milking, in many cases the milk flows into a **recorder jar**. In other cases it flows directly into the milk pipeline into which, on milk-recording days, flow meters are fitted.

The following figure shows the recorder jar set up for milking.

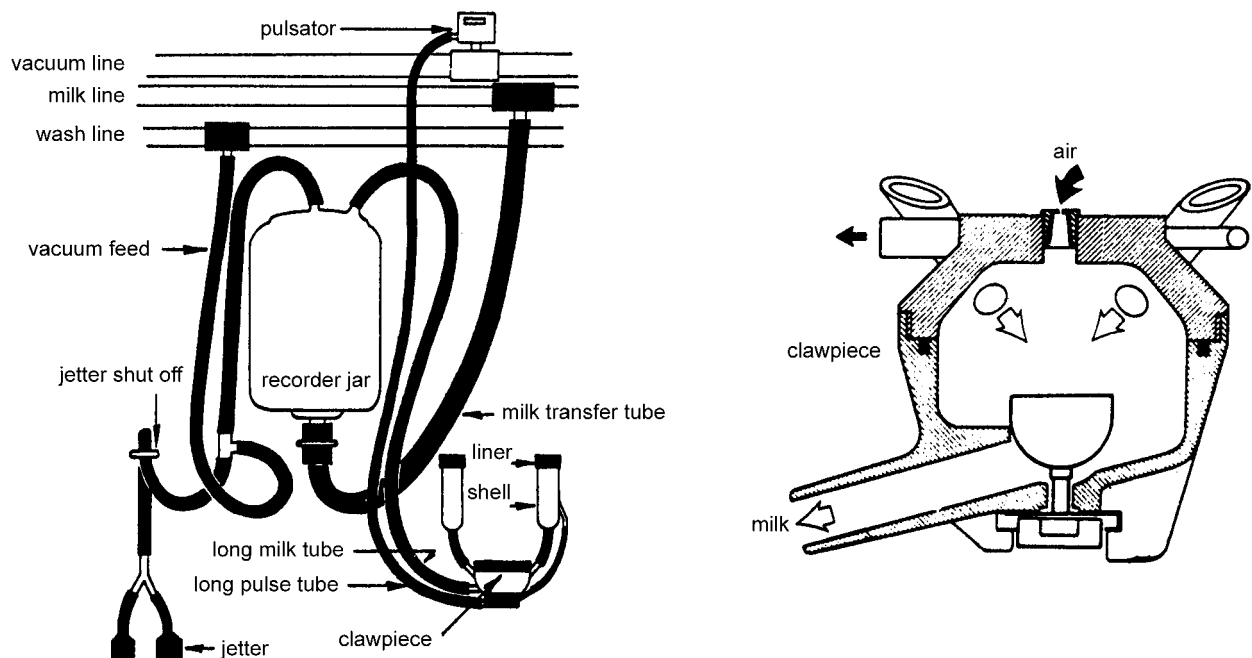

Figure 35:

Milk falls by gravity into the clawpiece and (by admission of an air bleed) will be conveyed into the recorder jar or pipeline. This can create problems with milk transport, as in most cases the milk goes upwards against gravity. The vacuum in the jar draws the milk upwards, but the weight of the milk in the tube draws the milk downwards by gravity.

In an effort to overcome this milk transport problem, lowline parlours have been introduced.

### Other auxiliary equipment

Other auxiliary equipment includes:

- devices which stop actual milking (no more pulsation) as soon as the milk flow has decreased to a certain pre-set level (with no automatic cluster removal)
- automatic cluster removal
- electronic registration of individual milk production
- devices which signal to the milker that there is mastitis or that a cow is in heat

➤ and other sophisticated auxiliary milking equipment in the milking parlour.

**Sensors** are becoming more and more important. However, increasing sophistication has its price (it costs money) and the technical level may well be too high for the persons who have to do the milking! Lastly, there is the risk of break-downs and spare parts which may not be obtainable.

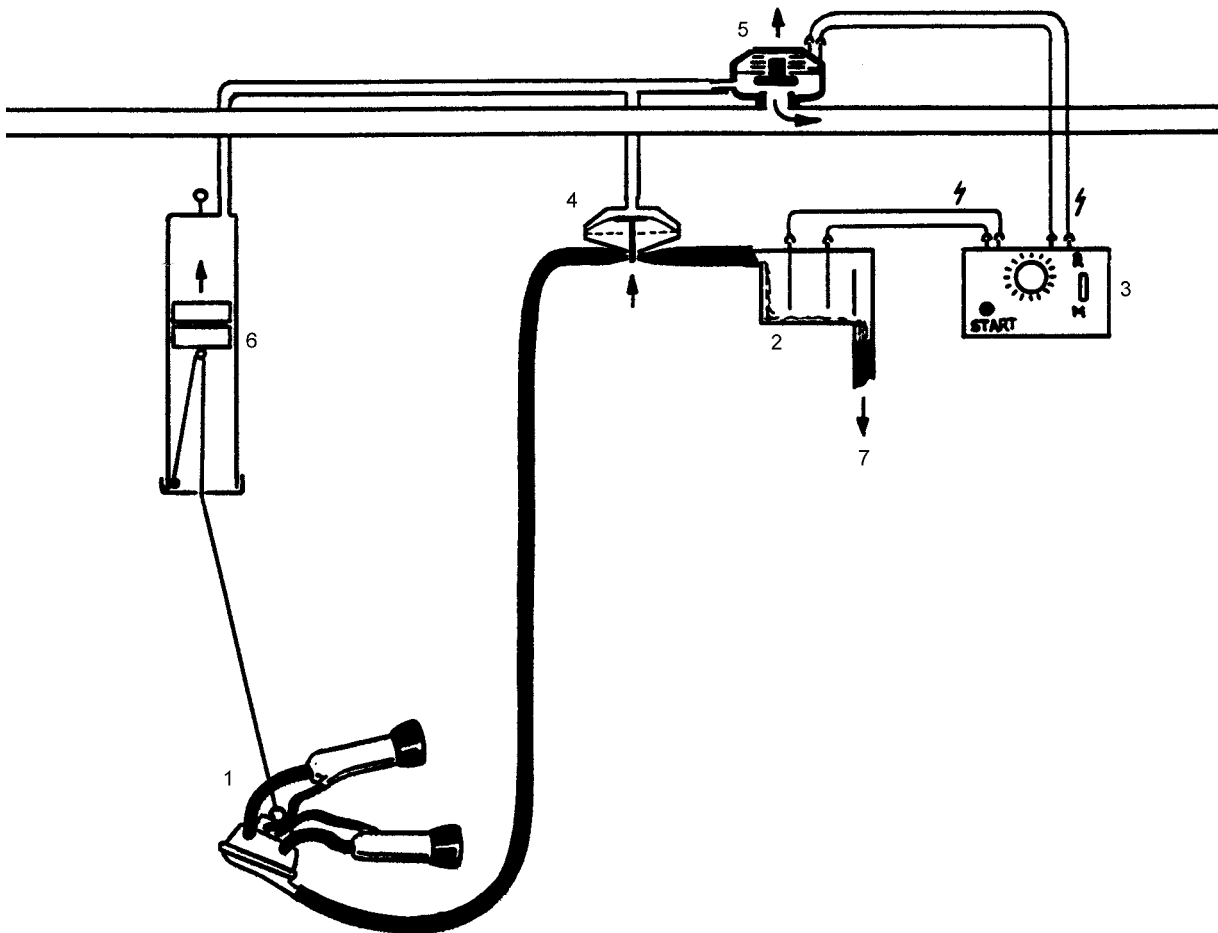

Figure 36: Automatic cluster removal

There is a milk flow recorder (2). If the milk flow is less than, say, 0.2 litre/minute for a certain period, say, 10-15 seconds, the vacuum valve (4) registers an impulse and brings atmospheric pressure to (5). This shuts off the cluster (1). Next the cylinder (6) has vacuum. The piston rises and the so does the cluster.

### The milker

In this chapter, and also elsewhere in this guide, techniques are described which are important for good machine milking. But little has been said about the milker, who must perform these techniques.

What are the qualities of a good milker:

- 1 He (or she) is able to carry out various technical operations correctly.
- 2 He is attentive, especially with regard to udders being 'empty' and to possible technical problems.
- 3 The milker should carry out all operations on time, quickly and calmly.

Unnecessary waiting periods should be avoided as far as possible; this applies to the cow, the milker and the equipment. This means that all operations should be carried out in an efficient order, that there is no superfluous walking to and fro, that the milker's reaction to problems is controlled and that the work is well organized. In short, the work is done **intelligently**.

- 4 The milker should know how to deal with animals: the cows should trust him. Therefore he should never become angry or otherwise react in an uncontrolled manner.

- 5 The milker should be an orderly person and have an eye for cleanliness.  
For example, equipment is always stored in the same way and in the same place; a dirty towel is replaced on time by a clean one; the cow's stall is cleaned, teat cup liners and hands are washed, and so on.

## 7 Machine milking : successive actions required of the milker

The following actions (A,B and C) are required of the milker, in succession.

### 7.1 Putting the milking equipment into working order

#### bucket type installation

- 1 The following is a logical sequence:
  - mount the lid and ring on the bucket; also the non-return valve and the pulsator
  - connect the long milktube and the pulsation tube and hang the milking unit on the bucket
  - connect the vacuum tube to the bucket.
- 2 Prevent twisting of the rubber parts:
  - make sure that the liners are correctly positioned in the teat cups (straight!)
  - be careful when mounting the short milk and pulsation tubes (align the teat cups before doing this)
  - also be careful when mounting the long milk and pulsation tubes
- 3 Some additional remarks:
  - place the ring in the lid flat
  - the mouthpiece of the liner must fit firmly onto the teat cup
  - check the tension of the liner; the tension should be equal to that of a new one (adjust if necessary, and if possible)
  - the direction of the tubes (starting from the lid) is the rotation direction of the handle.

#### milk pipeline installation

- 4 Here it is only necessary to mount the milking units.

### 7.2 What the milker should do when actually milking

#### Preparing for milking

- wear clean clothing and have clean hands; have short fingernails
- check whether the rest of the milking equipment is in working order (the milk strainer, the milk tank)
- check whether the small equipment has been prepared (cans, bucket with 5 litres of water, possibly bucket with concentrate, udder towels, spray can or cup)
- in the case of milking method PIU3 in a cowshed, a trough with about 20 litres of water should be put ready beforehand for rinsing the milking units immediately after milking
- start motor, check vacuum and number of pulsations; start the mixer of the milk tank
- when the milk starts entering the tank, check whether (or have it checked that) everything is functioning properly; do not forget cooling

#### Cow preparation

- the purpose is
  - to have a clean udder and clean teats (and therefore clean milk)
  - to stimulate the cow to let down her milk
  - to check on udder and milk

➤ how to proceed

- 1 Start by giving some concentrate (when this is the routine). This stimulates milk ejection; less milk will remain in the udder and this will result in higher production.  
In parlour milking, providing concentrate has other functions also, it may serve as ‘bait’ and it may be part of the ration.
- 2 Next the udder is briefly but energetically cleaned and massaged with a rough, dry udder towel (cloth). The teats especially must be well cleaned.  
When the udder is dirty, use plenty of water (bucket or hose). The water in the bucket should be clean.  
Dry the teats, preferably with a paper towel. Udder towels should be replaced when they have become soiled.
- 3 Draw two good squirts of milk from each teat; this makes the teat opening flexible and stimulates milk ejection. It is also a check on milk and udder. The milk squirts should preferably fall on a clean, smooth, dark surface so that the milker can observe the colour of the milk and notice whether clots are present.

additional remarks:

- abnormal milk should be kept apart; this also applies to colostrum, milk mixed with blood or milk with antibiotics.
- a cow with abnormal milk should, if possible, be milked last the next time.
- when the hands of the milker have been in touch with ‘bad’ milk, they should be washed with soap before he/she continues with the next cow.

### Connecting the milking units

Connecting the units to the udder is either done from the right or from the left side, according to what the cow has been accustomed to.

When the milker works from the right side, he should have the claw in his right hand and do the connecting with his left hand. The advantage is that kicks from the cow are somewhat easier to prevent or to avoid.

The teat connecting order is then left front, left rear, right rear, right front.

When making the connection, the teat cup should be held by its mouthpiece, in such a way that thumb and forefinger remain free to search for the teat and guide the teat to the teat cup.

There should be no suction; suction can be prevented by making a kink in the short milk tube and by steering (with the right hand) the milk claw in the desired direction.

When the connection is made, the milker should take care not to twist the hand with the teat cup, because the teat cup will turn back when let loose, resulting in a teat that is slightly twisted. The quarter concerned will then not be milked properly.

The teat cups should not come into contact with the floor and should not touch the legs of the cow.

When the connecting is done from the left, certain operations are done in the opposite way.

Cows with low udders are connected with teat cups closed off in order to prevent sucking in dirt from the floor.

### Removing the teat cups; checking

The milker should pay close attention to whether or not the cow has been completely milked. So-called blindmilking (udder already ‘empty’) should **not** last longer than about two minutes.

**The removal of the teat cups has priority over all other operations.**

On the other hand, the teat cups should not be removed too early; all four quarters should be empty.

To be able to make the right decision (by sight or by touch), the milker needs experience. Experience, together with attentiveness, are the right qualifications for a good milker. A milk flow indicator can render good services.

The teat cups are removed as follows (from the right side, with a standing bucket):

- shut off the vacuum (milk tap on the claw or on the lid, or by a catch lock)
- right hand at the claw
- place the left arm around the four teat cups and, with thumb and forefinger, admit air between teat and teat cup
- the four teat cups fall onto the left arm
- right hand applies vacuum for a short time in order to suck away the milk from the teat cups and milk tube (this practice is not recommended in the case of milk pipeline milking).

After a bucket unit has milked its last cow, the milker should immediately rinse it, in order to prevent the drying of milk residues.

## 7.3 Special cases

### Dipping/spraying

By treating the teats immediately after milking with a spray or a dip, the risk of udder infection can be reduced. At the same time the skin of the teat will remain smooth and flexible.

When spraying or dipping, the disinfectant should be freshly prepared. The spraying should be done accurately; especially the teat tips are important.

### Operations related to specific milking methods

Up till now the work has been described that has to be done in all milking methods. In this section the work is described that is related to specific milking methods only.

#### *milking with a standing bucket*

- The position of the bucket is important. The bucket should be placed obliquely behind the front leg of the cow, with the connection of the long milk tube directed towards the breast of the cow. Below the breast the milk tube makes a turn and runs straight to the udder, right under the belly. Some pulling power may be exerted on the teat cups and the udder by the long milk tube.
- An exchange bucket is useful for easy milking. It is then possible to place the lid (with the milking unit) of the full bucket onto the empty exchange bucket and immediately thereafter connect this to a cow. The emptying of the full bucket can then take place at a convenient moment.
- Often it is possible to milk two cows into the same bucket, one cow after the other. In that case the bucket remains standing between the two cows; one cow is milked from the right, the other from the left.

#### *milk pipeline milking*

- The unit is directly connected to the milk pipeline. It is then impossible to position the unit. Sometimes a yoke is placed over the shoulder of the cow; the milk- and vacuum tubes are then attached to this yoke (cowshed milking). In parlour milking there are other possibilities for positioning the long milk tube.

### Stripping

When a cow is thought not to have been completely milked it is possible to do what is called **stripping**. This can be done by hand or by machine.



In the Netherlands, handstripping is hardly ever done nowadays. It is only done in special cases, for example when udder infection necessitates complete milk evacuation.

Not only handstripping, but also machine stripping is done less and less in the Netherlands. Two reasons used to be given for machine stripping:

- 1 an empty udder leads to higher production;
- 2 stripping reduces the chance of udder infection.

The validity of both statements is debatable.

For **higher production**, it is much more important to stimulate the cow to let down her milk (i.e. proper udder preparation, concentrate effect, constant time lapse between preparation and connection of the milking unit, quiet during milking), resulting in little residual milk in the udder.

Moreover, the elimination of the 'last milk' is first and foremost a question of form and smoothness of the liners, the vacuum level and the sucking-resting ratio. When this is all correct, very little milk will remain in the udder, in any case so little that it will have no effect, or very little effect, on production.

As far as **infection** is concerned, it would appear that machine stripping has a negative, rather than a positive effect (stretching of the teat; milking lasts longer, causing possible slight injury to the udder tissues).

When the udder is healthy, a little residual milk in the udder is no problem and it is then better to omit stripping.

Only when there is infection, it is a good thing to evacuate all the milk. But then the best method is handstripping and not machine stripping.

## **7.4 Machine milking : what can go wrong and what should then be done ?**

Because one is dealing with live material, difficulties arise quite often which require special attention and action from the milker.

In principle, it is either the cow or the milking machine that causes the trouble; however, often the two interact. And, of course, the milker may not do his/her work properly (inexperience, lack of alertness).

The following is an attempt to classify the various problems that may arise.

### **There are problems with the cow**

- 1 The cow does not let down her milk
  - udder preparation has been insufficient
  - the cow has not been given concentrate, to which she is accustomed
  - the cow is on heat, sick, restless or easily frightened
  - unusual (bad) weather conditions
- 2 The cow is troublesome
  - the animal is young and not yet used to machine milking
  - sore teats
  - udder infection
  - rough treatment (the milker)
  - flies are troubling the cow
  - the cow has not received concentrate

- the pulsator does not function or does not function properly
  - milking continues after it should have stopped
- 3 The cow milks slowly
- low milking speed
  - the teats do not have the required form (especially teats that are too long)
  - the liner barrels of the teat cups have insufficient tension
  - vacuum is too weak
  - position of the milking unit is not correct
- 4 Too much milk is left behind and the cow must be stripped (hand- or machinestripping)
- 5 The milking is not 'square' (the milk flow from the four teats is uneven)
- the cow's udder is not 'square' (is irregular)
  - one teat is injured (the cow has stepped on it for instance)
  - a liner barrel is twisted in its teat cup
  - a kink in the short milk tube or in the pulsation tube
  - obstruction in the short milk tube, for example a teat pin
  - the pulsator does not function 'squarely'
- 6 The teats are bluish and hard when the teat cups are removed
- the teats are too small or too thin (for example in young animals)
  - udder inflation
  - milking continued after it should have stopped
  - the tension of the liner barrels is too weak
  - vacuum is too strong
  - air inlet of pulsator is obstructed / pulsator is incorrectly set
- 7 Hardened and bulging teat openings
- vacuum is too strong
  - pulsator incorrectly set
  - milking continued after it should have stopped
  - teats are too long with regard to the liner barrels
  - the speed of milking is too low

### **The milking machine is not in order**

- 1 After starting the motor there is no vacuum or insufficient vacuum
- the pump does not turn rapidly enough
  - the vanes in the pump are blocked; for example because milk has entered the pump
  - the lid of the interceptor is not air-tight
  - somewhere there is an open tap
  - somewhere a tube has got loose
- 2 The vacuum is too strong
- sticky valve in the regulator
  - regulator has been incorrectly set after a cleaning operation
  - regulator does not function because it has been shut off (for example for an inspection)
- 3 The vacuum fades away during milking
- safety overflow has started functioning
  - another milking unit has dropped off
  - a loose vacuum tube

- 4 The pulsator does not function
  - pulsator is out of order
  - some parts stick together
  - there is no vacuum in the pulsator
  - there is no electricity (in the case of an electric pulsator):
    - a blown fuse
    - insufficient contact between tap and magnet head
    - the coil of the electro-magnet has burnt out
  
- 5 The number of pulsations is too high or too low
  - pulsator is not correctly set
  - pulsator is dirty or worn out
  
- 6 The teat cups drop off
  - the vacuum is too weak
  - udder inflation
  - false air penetrates round the mouth piece
  - the weight of the unit is not balanced.

Many other technical problems may confront the milker. However, **REGULAR AND PROPER MAINTENANCE OF THE MILKING MACHINE** will do a lot to prevent trouble !

### **The milker**

A good milker, apart from doing routine work well in accordance with what has been written in other parts of this guide, will take the right measures in special circumstances.

These can be the following.

- 1 Mastitis (see also elsewhere in this guide)
  - symptoms are a hard and painful udder and abnormal milk
  - measures:
    - handmilk the affected quarter, in bucket or foremilk cup
    - repeat many times per day
    - consult veterinary officer when the result is disappointing
  - avoid infection of other cows:
    - after milking a mastitic cow, wash hands, rinse the stand and take clean udder towel
    - do not connect mastitic cows to the milking machine; milk mastitic cow(s) last
    - disinfect teats of all cows after they have been milked
    - in problem cases the use of a foremilk cup is recommended
  
- 2 Troublesome cows
  - young animals in particular may cause trouble in early lactation; they have to get used to the milking machine; the feeding of some concentrate may help
  - approach the animal in such a way that it is not frightened (talk to it, lay a hand on it)
  - act promptly and with assurance
  - make the connection with the milking machine quickly
  - when the animal kicks sometimes without being aggressive, the milking unit can also be connected between the hind legs (milk tube is directed backwards and does not touch the leg of the cow)
  - when the cow is really aggressive she may have to be forced to do what the milker wants
  - troublesome cows should never get an additional ration of concentrate

### 3 The milking of cows with an abnormal udder

- cows with three teats:
  - close the unwanted teat cup with a special stopper and place the teat cup over the claw
  - if there is no stopper, turn the teat cup in such a way that there is a kink in the short milk tube; pinch the teat cup between the tubes of the other teat cups
  - it is also possible to place a ring (φ 2-3 cm) around the folded short milk tube
- cows with very deep udders:
  - when placing the teat cups, first connect the two hind teat cups
  - shut off the other milk tubes by kinking them
- cows whose teats are too far apart:
  - use a milking unit with extended short milk tubes

### 4 Milking of newly calved cows

- collect the milk in a separate can
- take the teat cups away on time, especially with young animals, because the udder tissue is particularly vulnerable at this time
- keep the milk apart till the colour of the milk has become normal

### **In general**

A good milker keeps a close eye on how a cow behaves and how she reacts. A good milker notices sick cows and cows which are in heat.

**QUIET, CLEANLINESS AND REGULARITY are VERY IMPORTANT in dairy farming, particularly in milking.**

## 8 Cleaning and disinfection of milking equipment

Milk is **sterile** at its secretion by the milk cells in the udder. However, milk can rapidly become infected, even before it has left the udder.

The risk of infection is particularly great **once the milk has left the udder** and become exposed to a wide range of bacteria.

These bacteria eventually spoil the milk, more or less rapidly, in one way or another.

Cooling the milk is not good enough - it only prevents bacteria from multiplying; also, there are strains of bacteria which thrive at refrigeration temperature !

There are **three main sources of bacterial infection** of raw milk:

- the exterior of the cow's teats
- the interior of the udder (udder infection)
- the milking (and cooling) equipment.

In general, **the importance of proper hygiene cannot be over-emphasized**. Poor hygiene in milking and in equipment is likely to cause serious infection of raw milk.

As far as equipment is concerned, **all surfaces** that come in contact with milk should be thoroughly cleaned and disinfected **after every milking**. In addition, all rubber parts must be regularly checked for cracks and replaced when necessary. The formation of milk stone and other deposits must be prevented. The same applies to corrosion; surfaces must be kept hard and smooth.

Several **factors** are significant in the cleaning operation:

- 1 **Time**. The longer a detergent is in contact with a soiled surface, the better it is.
- 2 **Mechanical action**. Remember that using a nail-brush to clean dirty hands helps considerably.
- 3 **The temperature**. In general, chemical reactions are accelerated by increased temperatures; in the same way, cleaning is more effective at higher temperatures.
- 4 **Chemical action**. Chemicals can remove dirt from soiled surfaces and keep it in solution. They can also soften water and thus prevent the formation of milk stone.

There are various ways of making milking equipment (surfaces in contact with milk) clean again after use. The most simple and acceptable way would seem to be:

- 1 A lukewarm pre-rinse, to remove all particles that are loose:
  - when the bucket system is used, the vacuum pipeline should extend into the milkroom; the operator should do the pre-rinse immediately after the last cow has been milked.
  - the outer surfaces of all milking utensils should be cleaned separately, in order to avoid mixing dirt with the cleaning water.
- 2 Cleaning with hot water and a detergent
  - the hand milking utensils and the utensils for the bucket system should be cleaned in a separate trough
  - the pipeline system should be treated for at least eight minutes.
- 3 Disinfection of the cleaned equipment can be carried out after cleaning. However, it is often recommended to combine cleaning with disinfection; in that case combined detergents/disinfectants are used.
- 4 Finally a rinse with fresh cold water, in order to remove the residues of the cleaning solution and to prevent re-infection.

The above routine has proved to be suitable for both large and small plants, for milking and cooling equipment and for both automated and manual cleaning.

As milking takes place **twice a day, automation** of the cleaning / disinfection operation is rather attractive. An automatic unit ensures reliable, thorough cleaning/disinfection at all times.

Where hot water is difficult to come by, it is possible to apply the so-called NaOH cold water soak method, using two sets of rubber-ware with one set always soaking. Enquire locally for further particulars.

## 8.1 Daily cleaning and disinfection routine: bucket milking machine

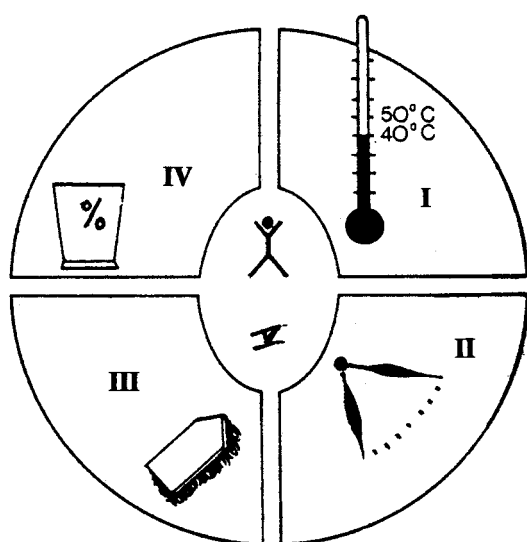

Five factors are significant in the removal of milk residues, dirt particles and bacteria from milking equipment:

- I = temperature
- II = time duration
- III = mechanical action
- IV = detergents/disinfectants
- V = the milker (the person who does the cleaning)

Figure 37:

### Required materials and equipment (see illustration next page)

- wash troughs (or tubs)
- 1 bucket
- dark brush (3)
- light brush (4)
- brush for liner barrel (5)
- long flue brush for long milk tube (6)
- short flue brush for short milk tube (7)
- tube remover (8)
- towel
- a dairy detergent, with graduated measure
- hypochlorite, with graduated measure
- (warm) water

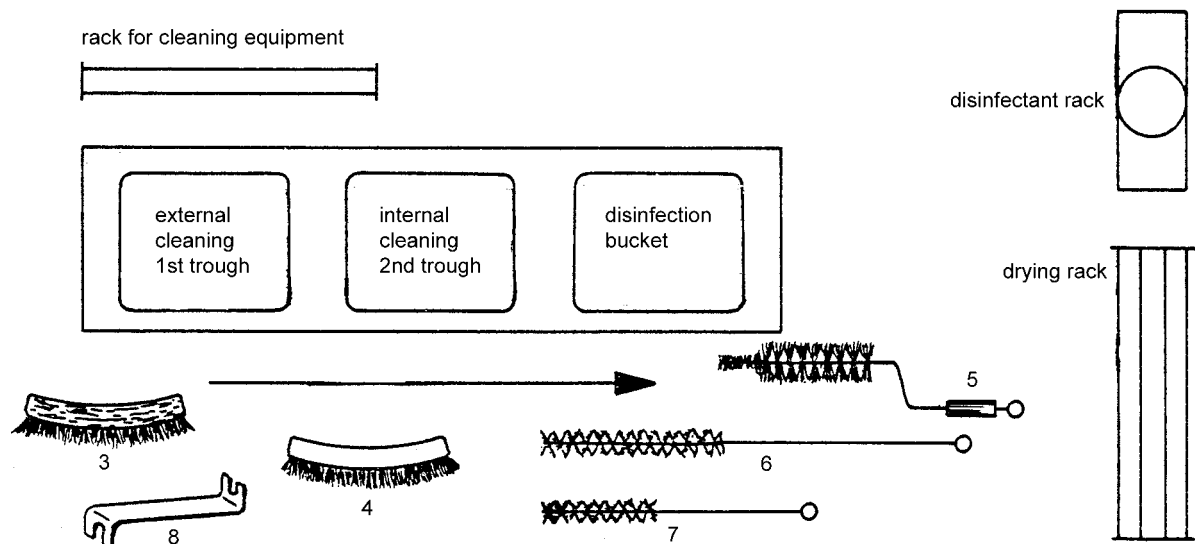

Figure 38:

The routine after every milking consists of the following steps:

- a pre-rinse with water
- a wash (outer surfaces first and then inner surfaces)
- disinfection
- storing the equipment on metal racks and hooks

In order to be able to rinse the equipment immediately after milking, water should be put in readiness before milking starts.

After taking away a unit from a cow for the last time, this water should be drawn through the teat-cups into the bucket (minimum 5 litres of water). Also rinse the milk strainer with this water. Immerse the used towels.

Next, the following equipment is set ready in the dairy room, from left to right (see illustration):

- 1 A trough with 20-40 litres of cold or tepid water, with the dark brush in it.
- 2 A trough with 20-40 litres of warm water (about 50 °C), with the light brush and the flue brushes in it.  
Add a dairy detergent; instructions for the quantity to be used are shown on the label. It is necessary to know the volume of water that is in the trough.
- 3 A bucket with 10-15 litres of cold water to which has been added the right quantity of hypochlorite (liquid or in tablet form). Hypochlorite should be stored in a safe place.

### The routine

- 1 External and internal cleaning of the unit
  - Clean the outside of the unit in the first trough, with the dark brush; do not forget to scrub the mouthpiece of each teatcup individually.
  - Place the unit in the second trough and scrub it internally, with the flue brushes. Scrub with the unit immersed in the water and always in the same direction (rotation).
  - Disconnect the claw and the long milk tube and scrub them; then mount them again. Connect the vacuum tube to the vacuum pipeline and draw about 5-8 litres of cleaning water through, a little at a time.
  - Disconnect the unit and immerse it in the bucket with the hypochlorite water. Make sure that the water can flow from the teatcups through the claw and the long milk tube. The water should **not** enter the pulsation tube. Hang up the unit, so that the water drains off as well as possible.

## 2 Vacuum tube and pulsator

- Disconnect the vacuum tube and scrub the outside, in the first trough; rinse it with water from the tap and hang it up.
- Remove the pulsator; take the loose parts off the lid (for example the return valve and the pulsator seat), scrub them and place them in the hypochlorite water (the pulsator itself must always remain dry).

## 3 Pulsator lid

- Scrub the outside of the lid over the first trough and the inside in the second trough. Remove the rubber ring and scrub it separately (all four sides). Scrub the connecting nipples under water and stack on the storage rack.

## 4 Milk strainer

- When all the milking units and all the lids have been dealt with, clean the milk strainer and the sieve bottoms, in the second trough; rinse with hypochlorite water and stack on the storage rack.

## 5 Milk buckets

- Clean the outside of all the buckets in the first trough. Make sure that water from the first trough does not get inside the buckets. Next clean the inside of the buckets, with the light brush. This means taking water from the second trough and transferring it from bucket to bucket while thoroughly applying the brush. Repeat. Finally rinse the buckets, inside and out, with hypochlorite water and stack them on the rack.

## 6 Udder towels and water bucket

- Disinfect the flue brushes and the light brush and put them away.
- Rinse the towels in the first trough and place them in the second trough.
- Clean the water bucket inside and out with the dark brush and fill it with hypochlorite water.
- Scrub the towels one by one, against the side of the trough or on a clean piece of floor. Rinse them in the second trough and put them in the bucket with hypochlorite water.
- Scrub the troughs (also externally) and rinse with hypochlorite water from the bucket. Also treat the brush with this water. Finally wring out the towels and hang them on a clothes-line (preferably out of doors).

## 7 Just before the next milking

- After everything has been remounted, draw hypochlorite water through the unit once more. Rinse **thoroughly** before starting milking.

### *Note*

With a special washing outfit it is possible to clean the milking units by letting the cleaning water circulate in surges.

Usually a combined detergent-disinfectant is used in this case.

It is then no longer necessary to work with brushes.

The routine is then different:

- first clean the units externally
- connect the units with the washing outfit
- then clean the rest of the milking equipment
- rinse the units with water from the tap and hang them up.



## 8.2 Daily cleaning and disinfection routine: milk pipeline installations

### Required materials and equipment

- wash troughs (tubs)
- brushes
- dairy detergent
- disinfectant
- **or** a combined detergent-disinfectant
- (warm) water

### steps

- removal of manure and dirt
- removal of milk residues (pre-rinse)
- cleaning
- disinfection (usually combined with cleaning)
- rinsing

There are no real differences between the cleaning of the milk pipeline of a cowshed and that of a parlour.

In the first case the milking units are carried to the dairy room, where they are placed in a wash trough.

In the second case the milking units remain in the parlour ('inplace cleaning'); they are connected to so-called jettors which draw water from the wash trough, through the cleaning circuit.

### The routine

#### 1 Exterior of milking units

- Immediately after the last cows have been milked, the outside of the milking units is cleaned with a dark coloured brush and cold water. In parlours one can make use of a shower for this work. The mouthpieces of the teat cups should each get a special, separate scrubbing.
- Next the milking units are connected to the jettor **or** placed in the wash trough.
- If a trough is used, fill this trough with lukewarm water (about 35 °C); the quantity such be such that alternately water and a little air are taken up.

#### 2 Evacuation of all remaining milk; removal of the filter

- In the **cowshed**: empty the milk pipeline by drawing a small sponge through the line. In the **parlour**: admit air into the rear milking units.
- Empty the milk receiver (manually).
- Evacuate all milk that is in the pipeline between the receiver and the cooling tank.
  - if this is a piece of flexible tubing, disconnect it behind the filter and raise it, so that the milk flows into the tank (or into cans)
  - if it is a fixed line, draw some clean water into the receiver (in accordance with the capacity of the line); remove this water and immediately afterwards disconnect the line from the tank.
- When the filter is taken away, the water will flow back, there will be no mixing of water and milk
  - take away the filter and put it in a (closed) waste bucket; do not use the filter a second time
  - connections in this line which are regularly loosened, should be allowed to leak somewhat during the operation described above; this ensures the necessary cleaning of the threads.

#### 3 Pre-rinsing of the milk pipeline

- Connect the cleaning circuit to the wash trough with lukewarm water, in such a way that the trough is sucked empty through the milk pipeline and the milk receiver; this water should not be recollected.

#### 4 The actual cleaning and disinfection

- During pre-rinsing, fill the second trough with hot water (70-80 °C) and add the required quantity of combined detergent-disinfectant (usually ½%).
- Place the milking units or the cleaning circuit in the second trough; keep the delivery line out of the trough. Draw water from the trough; when the water that drains from the delivery line is sufficiently warm, this line should also be placed in the trough ('circulation cleaning').
- Let the fluid circulate for 10 minutes (maximum).  
At the end of the cleaning process the temperature of the water should still be 40 °C (minimum); if this proves not to be the case, water with a **higher** initial temperature should be used.  
Another possibility is a shorter circulation period or the draining away of more water at the start of the cleaning process.
- **Once a week** the combined detergent-disinfectant should be replaced by an acidifier, in order to remove milkstone. Store them separately as mixing may create dangerous situations!

#### 5 Post-rinsing

- During the actual cleaning, refill the first trough with cold water.
- When cleaning ends, place the cleaning circuit for the milking units in this trough.  
Draw water and do not recollect it; it can be used for cleaning the floor of the dairy room.

#### 6 Water evacuation

- After the milking machine has stopped, open the drain valves (that have been installed for this purpose) so that all the water can drain from the lines.

#### Remarks

On many farms (in the Netherlands and elsewhere) cleaning and disinfection of the milking machine is automated.

The equipment should be programmed in such a way that the working order is in accordance with what has been described above.

The most important advantage of automated cleaning is that the cleaning is **always carried out according to a fixed schedule**.

The cleaning process produces **waste water** containing milk residues and disinfectant/detergent.

The following page schematically shows automated circulation cleaning.

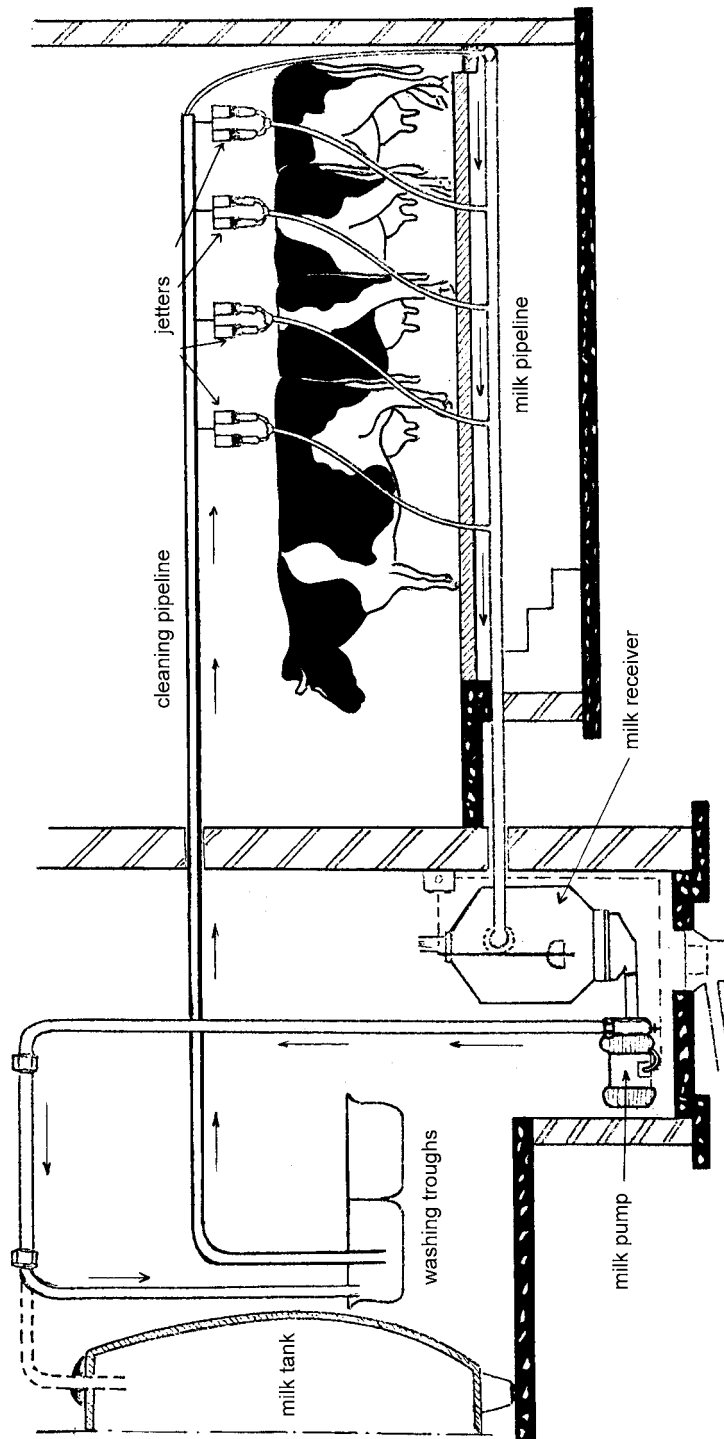

Figure 39: Automated circulation cleaning

## 9 Mastitis and its prevention

Wherever herds of cows are kept for commercial milk production, ‘mastitis’ is present: at least as something which needs constant attention and very often as a major problem.

### 9.1 What is mastitis?

The milk in the udder of a healthy cow contains very few bacteria and not many body cells either. When there is something wrong with the udder and the number of body cells or the number of bacteria (or both) increases sharply, it is said that the cow is suffering from mastitis.

The symptoms relating to the milk, the udder or the cow herself can vary widely, depending on the type of pathogen and the susceptibility of the cow.

The cow may just have a slight rise of temperature or may be seriously ill; sometimes a cow may even die of mastitis.

The udder can show various responses: a quarter may be temporarily slightly warm to the touch, but it may also be ‘red hot’ and painful.

After an acute infection, a quarter may become normal again, but it may also remain permanently enlarged and hardened. A quarter may wholly or partially lose its capacity to produce milk.

As far as the milk itself is concerned, the abnormality may be hardly noticeable or may be very clear. The milk from seriously affected quarters has a bad smell, is bloody, purulent, clotted, and may have a very abnormal chemical composition. In less serious cases, the appearance may be quite normal and clots are only found in the first few squirts, but the chemical composition deviates from that of normal milk.

Internationally the following **definitions** are used.

- 1 **Normal udders** are udders which show no outward signs of a pathological condition; the milk is free from pathogenic organisms and has a normal cell count.
- 2 **Latent infections** are present when the milk contains pathogenic organisms but has a normal cell count.
- 3 **Non-specific or aseptic mastitis** is present when there is no recognizable infection (and no pathogenic bacteria present in the milk) but when there is a markedly increased cell count.
- 4 **Subclinical mastitis** does not show an inflamed udder but microscopic examination of the milk reveals udder infection (pathogenic bacteria), and/or an increased cell count and sometimes alterations in the milk (milk clots). Under certain conditions (the weather; wrong milking techniques) subclinical mastitis may become ‘clinical’.
- 5 **Clinical mastitis**; one speaks of **acute mastitis** when there are obvious signs of inflammation of the udder, such as heat, pain and swelling. The milk is clearly abnormal (no microscope needed !) and the cow may have a raised temperature.  
One speaks of **subacute mastitis** when a quarter fails to respond to treatment over a period of time.

Sometimes it is only the teat canal which is infected (colonized); there are pathogens in the milk but there is no increased cell count.

Subclinical cases and teat canal infections are important sources of infection (for other cows) via the milking equipment that is used (especially worn-out teat cup liners).

**Mastitis generally starts by udder pathogens penetrating into the teat canal.** But this penetration does not always lead to inflammation. Teat canal infections sometimes precede inflammation.

It is likely that in many cases aseptic mastitis (cell count in milk too high) is also caused by udder infection (subclinical mastitis with milk without pathogens at the time of the analysis).

There are various **methods** and **tests** for the detection of mastitis. Usually they require a laboratory and the results need careful interpretation. This subject is not dealt with in this guide.

In **daily practice** the observant milker will soon discover if something is wrong with one or more cows: clots in the first few squirts, abnormalities to the touch or to the eye. Especially the more striking clinical cases are easily recognized. However, it should be realized that, like the proverbial iceberg, they represent only a fraction of the mastitis cases in the herd. The milker should be aware that the inconspicuous subclinical form can cause far greater economic losses !

Investigations have shown that a cow suffering from subclinical mastitis in one udder quarter loses on average 10% of her possible milk yield.

With regard to **treatment**, antibiotics are widely used but they **have many disadvantages**. Apart from the fact that they are not effective against all infections, their use means loss of milk during the whole treatment period and for up to five days after this period, because the milk of cows under treatment **cannot be used by the processing factories**.

What is more, antibiotics cannot prevent new infections. Treatment with antibiotics should therefore be restricted to clinical cases as soon as they appear and to subclinical cases only at drying off.

More information on the subject of treatment should be sought elsewhere (textbooks, local veterinarian).

## 9.2 How does mastitis develop ?

As the udder is a very productive organ, it is sensitive not only to mechanical damage, but also to sudden environmental changes (draught, sudden big temperature differences). Under such conditions resistance to infection may temporarily be low.

In the udder pathogens (generally bacteria) find conditions favourable for rapid growth. They then affect the udder tissue. The cow's body resists this 'attack', partly by sending white blood corpuscles, which kill the bacteria, to the threatened tissue.

Many such 'somatic cells' and bacteria are secreted into the milk during this process.

The important mastitis-causing organisms (Staphylococci and Streptococci) are almost always present on the skin of the teats, so the risk of infection is almost always there. But this risk becomes a real threat when there is **regular** strong contact with mastitis bacteria, for example from infected teatcup liners, or infected hands, or when there are many flies around.

Teat openings that are not quite normal, teat lesions and sores encourage the growth of bacteria on the teats. The presence of bacterial colonies near the opening makes the penetration of these bacteria into the udder more likely.

The teat canal is a natural barrier, but it is not always able to resist invasion by bacteria. Factors such as the condition of the milking machine and how it is used, and damage to the teat canal orifice and the teat canal itself play a role, but also whether or not the teat-closing muscle works well.

Presumably the bacteria penetrate into the udder between milking times. One may imagine that during milking the bacteria are 'washed away' again by the milkstream. On the other hand it is likely that during machine milking, when there is intense movement of liquid and air caused by sudden strong vacuum changes, bacteria may be 'shot' into the teat canal (so-called impacts).

When a cow already suffers from subclinical mastitis, draught, sudden temperature drops, poor milking, etc., may lead to clinical mastitis.

### 9.3 Mastitis prevention

Antibiotics are important when a farmer wants to treat cows that are clearly suffering from mastitis. But during lactation latent infections and subclinical cases are not treated, and it is these cows which will spread the disease. **So the use of antibiotics** should not receive all the attention. On the contrary, the right **preventive** measures would seem to be much more important.

Measures that will prevent the disease from spreading should be sought in the context of:

- hygiene
- housing
- prevention of teat damage (lesions, sores)
- proper use of a well-functioning milking machine

#### Hygiene

Proper hygiene during milking is very important. The milker should prevent teats and openings from becoming infected with mastitis bacteria, which are always present here and there in a dairy herd; the milker should make it difficult for the bacteria to spread to other cows.

The following measures decrease the risk of infection:

- 1 Milk cows last that clearly suffer from mastitis.
- 2 Produce the first few squirts by milking the cow by hand; preferably check the milk with the fore-milk cup.  
Never milk into the hand or let milk fall onto a place where the cow lies down.
- 3 After milking, disinfect the teat cup liners properly and replace them by new ones when necessary  
Do not economize on teat cup liners. Preferably use paper towels that are discarded after use.
- 4 Hands should never be in direct contact with milk.
- 5 When water is used to clean the udder, this water should be changed frequently; add a disinfectant when possible.
- 6 If feasible, feed the cows immediately after milking so that they will not lie down too soon. This will give time for the teat canal orifice to close properly.

The above measures will **not** always prevent infection.

In order to **decrease the risk of infection further**, farmers are increasingly advised to dip or spray the teats immediately after milking with a proper disinfectant. Germs that are present on the teats are then killed (if the dipping or spraying is done correctly), especially those that have 'arrived' during milking.

The bedding of the cows should be as clean as possible.

#### Construction, condition and use of the milking machine

Milking with a milking machine may damage the teats to some extent, particularly the openings and the teat canals, resulting in easier penetration of bacteria into the udder.

Strong and/or sudden **vacuum changes around the teats** favour the penetration of bacteria.

Causes of injury to teat canal and teat canal orifice:

- the cow is a slow milker
- the teat cup liner is too wide
- the vacuum is too strong during milking
- the pulsator does not work properly
- 'blind milking' that really lasts too long

Irregular vacuum drops due to sudden air intakes ('impacts') are very unfavourable to udder health. This is partly a matter of machine construction (e.g. capacity, regulator, number of milking units). On the other hand, when connecting or disconnecting a unit, it is important to limit the additional air intake as much as possible. Careless handling leads to vacuum drops in units which are connected, especially when the reserve capacity of the installation is low and the milk pipeline is long or too narrow

It should be clear from the above **that, especially in view of mastitis, the milking machine should be tested and serviced regularly**; it should always be in good working condition.

### **Housing; teat damage not caused by the milking machine**

This is particularly important in temperate and cold climates.

### **Summary**

An effective control system may be summarized as follows.

- 1 Follow good general husbandry and milking practice, as described. Regularly check and service the milking machine.
- 2 Follow a simple hygiene routine as described. Dip the whole teat in an appropriate solution immediately after the milking unit has been removed, or spray with a spray can.
- 3 Apply antibiotics under veterinary supervision
  - to all cows, as a routine at drying off
  - to clinically affected quarters; keep treatment records and cull the cows with recurrent clinical mastitis.

### **Note**

From a recent doctoral thesis (year 2000).

The bacteria which cause mastitis can easily enter into udder cells; antibiotics cannot.

Mastitis is an udder disease which cannot be fully controlled so far, despite intensive research efforts, An infected cow will never entirely get rid of the bacteria. And the bacteria will immediately start multiplying in the udder once they have entered.

# 10 Periodical maintenance of the milking machine

A milking machine needs to be checked once every month by the person in charge of the machine. Certain parts of the machine are subject to wear and tear and should be replaced periodically.

If this monthly check is neglected, it has repercussions on the **quality of the milk** and the **health** of the cows.

In the long run, neglect affects the working life of the installation.

## Maintenance and control items

### 1 The milking unit

#### the teat cup liners

- Check the cleanliness and the state of the rubber. To do this, it is necessary to remove the liners.
- The pulsation chamber should be dry. If it is moist, it probably means that the liners are leaking; if this is not the case, it is due to poor daily cleaning.
- The rubber of the liners should be smooth and shining and have a round form. If the form has become oval, it is time to replace the liners. The rubber should not develop cracks or be broken.
- In certain cases it is possible to ‘renew’ the liners (stretching). If that possibility does not exist, worn-out liners should be replaced.
- In any case, the liners should be replaced once or twice a year, depending on the work load and the cleaning method.

#### the milk tubes

- Milk tubes should not develop cracks or be broken.
- The inner surfaces should be smooth. If they have become rough, it is time to change the tubes.
- The milk tubes should be flexible. If they have become rigid, it is time to change the tubes. Transparent tubes made of nylon easily become rigid.

#### vacuum and pulsation tubes

- They should not have leaks or be broken.

#### the milk claw

- The milk claw should be clean and have a smooth surface. The air hole should not be obstructed. There should not be any cracks.

#### the cluster

- The non-return valve should be clean and functional. The joint should be clean and in good shape.

#### the bucket

- The bucket should be clean and have a smooth inner surface (sometimes one finds calcareous deposits, which should be removed).

#### the cleaning nipples

- They should be clean.

### 2 The motor

- The vanes of the air-cooling system should be clean (no dust and no oily surfaces).
- The ventilation holes should be clean.



- The engine oil (internal combustion engine) should be changed every 100 working hours.
- Check spark plug(s) and the points of the breaker set (petrol engine).
- The air filter should be cleaned once in a while (change the element when necessary).

### 3 The fan belt

- the pulley of the motor and the pulley of the pump should be in line with each other
- the fan belt should fit the dimensions of the pulleys
- check the condition of the fan belt (wear and tear, cracks)
- check the tension of the fan belt (about 1 cm play)

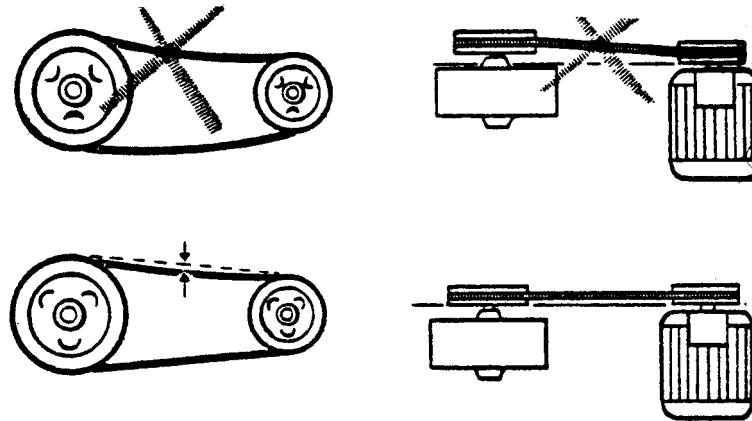

Figure 40:

### 4 The vacuum pump

- The cooling vanes should be clean.

#### lubrication

- Make sure that the lubrication system functions normally.
- Check the oil level and top up if necessary.
- If the oil is re-cycled, it is necessary to change the oil twice a year.

### 5 The interceptor

- Check the interior cleanliness. If the inside is dirty, the vacuum pipe is dirty too.
- Check the gaskets of the automatic drain valve and the overflow.

### 6 The vacuum meter (gauge)

- The pointer (needle) should be clearly visible; it should be at 'zero' position when the motor is not working.

### 7 The regulator

- The protective cover and the valve should be clean (no dust).
- Check the vacuum level.

### 8 The vacuum pipe

- Check the state of the rubber joints.
- Inner surfaces should be clean; if not, the pipe should be flushed with a detergent solution (basic reaction).

Generally speaking this should be done once a month, as follows:

- Flush the pipe with **hot water**, to remove dust and to moisten dust particles; hot water can be drawn through the pipe via a vacuum tap at the end of the line.  
The amount of water should not be more than 3/4 of the volume of the interceptor.
- Let air enter at the same time, to create turbulence.

Make sure that the water flows in one direction only. When the installation has more than one dead end, water must be drawn through from each end.

Once the water has passed through, the motor must be stopped in order to empty the moisture trap.

- Repeat this operation, but now with a **hot detergent solution** (with a basic reaction) that is not foaming and not corrosive.
- If the pipeline is **very dirty**, it is necessary to start with the taps that are nearest the motor and then continue with the taps further away. Otherwise the pipeline may become completely blocked.
- After the detergent solution, rinse with **water**. At the same time, clean (brush) the inside of the moisture trap.

## 9 The vacuum taps

- Every three months it is necessary to clean the taps (hot water, with a detergent). Where necessary, lubricate at the same time.

## 10 Drain valves

- They should be clean and well-closed when the motor works.

## 11 The milk pipeline

- There are two kinds: stainless steel and transparent pipelines.
- Check interior and exterior cleanliness, especially near the milk filter. Check whether there are calcareous deposits on the inner surfaces.
- Check cleanliness and air-tightness of the **joints** (leaks cause the milk to become foamy).
- Check the cleanliness of the outer and inner surfaces of the (milk) jars in the milking parlour.
- Check cleanliness and air-tightness of the milk taps.

## 12 The milk receiver

- The outside of the receiver should be cleaned from time to time. When there are calcareous deposits, an acid detergent should be used instead of one with a basic reaction. Check the cleanliness of the inside, especially the upper part.
- Check the milk level control system; the releaser pump should only work when there is milk (it should not function 'dry').
- Check the cleanliness of the **milk releaser** pump. The motor of the pump should be clean and dry. The non-return valve should be clean and functional. If the valve does not close properly, this will show when one fills the receiver with water; rising air bubbles indicate a leaking valve.
- Check the cleanliness of the filtering system. Check the functioning of the sanitary trap by filling up with water. Check cleanliness and functioning of the drain valve.

## 13 The pulsation system

- **Bucket system**: check the number of pulsations/minute at each bucket. This number should be the same for all buckets.
- **Milk pipeline system**: check the pulsation rate; it should be the same for all units operated by the same pulsator. If this is not the case, the relay pulsators should be checked.
- Check cleanliness of the protective cover of the amplifiers.
- If necessary, lubricate the drive of the pulsator.

## 14 The milk tank

- The milk tank should be clean, inside and out. The tank should be periodically cleaned with a detergent solution. Use an acid detergent in the case of calcareous deposits.

- Check the interior of the tank. Locate calcareous and fatty deposits, especially at the level of the mixer and in the corners of the tank.
- If there is dirt, it is necessary to check the cleaning system.
- Check the cleanliness of the lid's gasket and the tank tap.
- Check the cooling temperature of the milk; it should be 4° Celsius.

**Note:** After checking the milking installation as described above, it is necessary to rinse the system.

# 11 Tests carried out by milking machine technicians

Milking machines need maintenance and checks, in order to keep functioning properly.

Apart from daily, weekly and periodical maintenance, it is necessary to let a technician (a milking machine specialist) **test the milking machine once a year**, to check the functioning of various parts and to adjust or change parts that are no longer functioning properly.

This chapter pays attention to

- norms for the functioning of the milking machine
- common faults
- various tests (measurements) carried out on the milking machine
- further maintenance jobs

## 11.1 Norms

### The vacuum pump

A vacuum pump is characterized by its 'capacity'. The capacity depends on the volume of the pump's cylinder and the speed of the pump (i.e. number of revolutions per minute).

The characteristics of the pump are indicated on the plate:

- make (name) and type
- (max.) number of revolutions per minute
- output at 50 kPa, in litres of air per minute at atmospheric pressure
- how the pump is lubricated

A milking-machine pump should have a certain minimum capacity (also called base-, reserve- or over- capacity) to be able to correct small vacuum fluctuations when the milking machine is working. Such fluctuations occur for instance when liners are put to teats. 'Minimum capacity' permits milking to take place without noticeable changes in the vacuum level.

For internationally accepted norms and standards, refer to ISO recommendations 3919 (terms and definitions), 5707 (construction and performance) and 6690 (testing).

*Table 6: Recommended minimum free air capacity of the vacuum pump in litres per minute at different numbers of units (source: IKC Lelystad)*

number of milking units	bucket type installation	milk pipeline installation (circulation cleaning)
2	250 litres/minute	330
3	300	
4	350	425
5	400	
6	530	675
8		1000
12		1400
16		1700
20		2000

### The vacuum pipe or pipeline

The diameter of the vacuum pipe(s) should correspond with the capacity of the pump.

The main pipe should have a diameter which is at least equal to (not less than) that of the pump entrance (where the vacuum pipeline is connected to the pump). In this way vacuum differences within the installation are kept to a minimum.

Table 7: Standards for the minimum vacuum pipeline internal diameter in relation to the quantity of air extracted per minute at constant air flow; pipe length 30 m (source: IKC Lelystad)

air flow in litres/minute	internal diameter (mm)	section surface area in cm <sup>2</sup>
less than 300	25 mm = 1 inch	5.0
200 - 600	38 mm = 1½'	11.3
600 - 1000	50 mm = 2'	20.4
1000 - 1700	63 mm = 2½'	31.2
over 1700	76 mm = 3'	45.3

### The milk pipeline

Refer to pages 37-38 of this guide.

### The regulator

The vacuum pump draws air from the vacuum pipeline. Air enters the vacuum pipeline mainly through the milking units; the milking units are 'consumers' of air.

It is the **regulator** that keeps incoming and outgoing air in balance, it maintains the vacuum at a certain level.

In practice, when only a few milking units are operating, a lot of air has to enter the system through the regulator to maintain the vacuum at a certain level. However, in this case the vacuum is slightly higher (i.e. less air) than when all units are operating.



Figure 41:

Because of its construction, a regulator can only allow a certain amount of air to pass, it has a **maximum capacity**. This maximum capacity should be higher than (or at least the same as) that of the vacuum pump.

Normally one finds the capacity of the regulator indicated on the regulator.

Sometimes it is necessary to mount more than one regulator on one installation. The total capacity should then be the same as (or exceed) that of the pump.

Regulators should not be mounted opposite each other or be positioned on one single T-piece.

When there is more than one regulator in an installation, they should be adjusted differently, as this will prevent vibrations and pressure fluctuations in the system.

With a regulator it is possible to increase or decrease the vacuum level in an installation, by adjusting the weight or the tension of the spring. However, this will not eliminate the pressure differences existing within the system.

Lastly, the regulator should be fitted in the main pipe (the largest diameter), somewhere between the vacuum pump and the point where secondary pipes branch off from the main line.

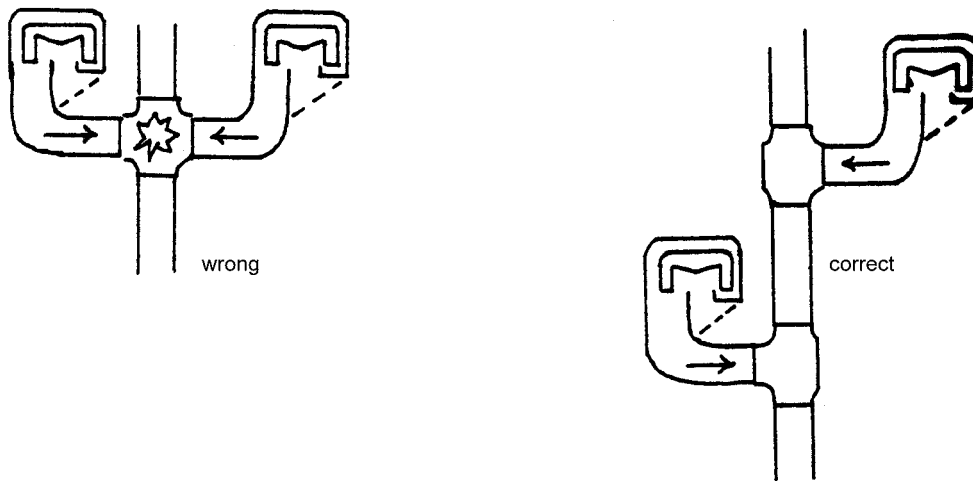

Figure 42:

## 11.2 Test equipment

The following equipment is needed to test (to measure) the functioning of a milking machine:

### a vacuum (test) meter

This meter is based on the mercury column (of the physics class at school) and graduated in cm Hg or in kPa.

It is a very precise instrument but it breaks easily !

### an air-flow meter

This instrument measures the amount of air evacuated by the pump, in litres per minute. It is calibrated at the factory.

### a revolution counter

To count the number of revolutions made by the motor or the vacuum pump.

### a pulsator tester

An electronic instrument to check a pulsator and its phases (refer to pages 33-36).

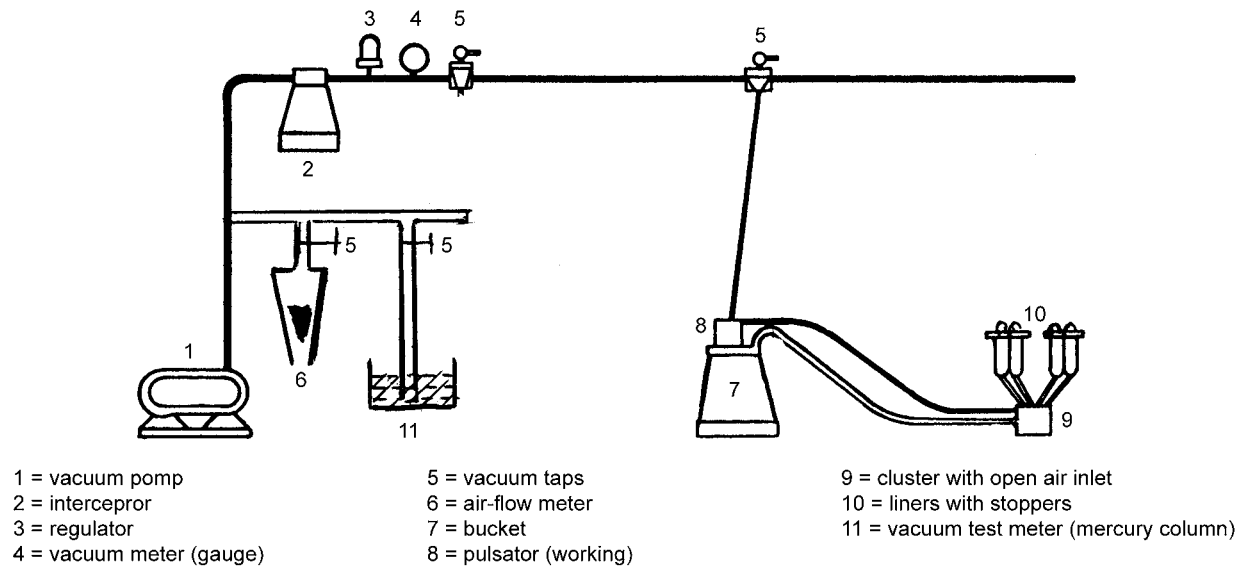

Figure 43: Diagram of a milking machine with an extra piece of test pipe, with an air-flow meter and a vacuum meter

**Note:** for convenience sake in the drawing the meters have been placed between the interceptor and the vacuum pump. In reality this should **not** be the case; there should never be anything between interceptor and vacuum pump.

### 11.3 Various tests carried out on the milking machine

The duration of the working life of a milking machine **depends to a large extent on the maintenance that is provided.**

Improper functioning may be due to the:

- vacuum meter
- regulator
- vacuum pump
- power transmission
- engine of the pump
- vacuum pipe(s) and milk pipeline

**Milking machine testing methods and procedures may vary somewhat between one country and another, although internationally accepted standardization is the aim. On the following pages (up to page 85) a specific procedure is described by way of example. The outcome of the tests is compared with norms which in reality, in a given country, may be slightly different. In reality in certain countries tests may be more elaborate and detailed.**

#### Vacuum meter test

The vacuum meter of the installation should indicate the level of the vacuum. The meter should be easy to read, reliable and fairly precise.

A vacuum meter in an installation may show a value which is too high or too low (i.e. it does not record the actual pressure). This is misleading and may result in milking with a vacuum that is too strong or too weak.

A weak vacuum (i.e. pressure in the system is too high) increases the duration of milking. A vacuum that is too strong (i.e. pressure in the system is too low) may endanger the health of the udder.

**Test:**

- First of all, read the position of the needle with the motor stopped; it should be 'zero'. If this is not the case, the precision of the meter is doubtful.
- Start the motor and watch the rise of the needle of the vacuum meter. The rise should be **regular**, i.e. without jerks.  
If the needle rises jerkily, the meter is in questionable shape (perhaps there are vibrations in the system?)
- Next **one** milking unit is connected to the vacuum pipe, with its teatcup liners closed with stoppers (to imitate reality).  
Note the reading of the vacuum meter of the installation and that of the test vacuum meter.
- Repeat this operation, with **all** units connected (but with stoppers). Note the readings. The difference should be less than 3 kPa (that is the norm).



**An example of a test result, based on reality.**

A form has been used to write down the test results. This form is reproduced below:

Date of test ..... **10.08.1994**  
 Name of owner ..... **Mr. Dairyman** Address ... **Green Valley**  
 Supplier ... **Milkflow Ltd.** Installation date .. **01.03.1992**  
 Make . . . **Daisybird** System ... **buckets** .....  
 Number of units .... **4** Number of cows .....

**Vacuum meter:**

- where placed: **at entrance of stable**
- needle with engine stopped: **"zero" mark**
- rise of needle: regular/~~irregular~~
- at full operating level the needle is: ~~stable~~/fluctuating
- the meter functions: ~~with vibrations~~/without vibrations
- type of meter: ~~glycerine~~/other

	a	b	a-b = c	d	e
Test Programme	farm meter	test meter	difference	norms	re-marks
1 one unit connected	52	53.3	1.3		
2 all units	51	53	2	3 kPa	
2-1	0.3	2 kPa			

**regulator:**

- type of regulator: ~~spring/weight/sensor~~
- position of the regulator : **between interceptor and vacuum meter**
- conclusion:

Figure 44: Test result

**Comments**

With the engine stopped, the needle of the vacuum meter is at the 'zero' mark; at first sight this means that the meter functions as it should.

The needle rises regularly which is good. At operating level the needle fluctuates; this means that the meter is not properly set (perhaps the meter is faulty).

There are no vibrations. Often, in a vacuum pipeline there is a rubber piece (vertically mounted) between the vacuum pipe and the pump, to prevent vibrations and to protect the vacuum meter.

The vacuum meter is not of the 'glycerine' type; this is no problem here because there are no vibrations.

*Test nr. 1*

With one milking unit connected, the difference between the readings of the farm meter and the test meter is noted; it is 1.3 kPa. Hence the vacuum is in reality stronger than we thought at the farm. This is all the more serious because the (real) vacuum should not be stronger than 50 kPa!

*Test nr. 2*

With all units connected, the difference is 2 kPa.

Conclusion: there is a difference, but the farm meter can still be used because the norm is 3 kPa (maximum). However, the vacuum is too high (it should not have been more than 50) and the regulator needs adjustment.

*2-1*

The difference 'one unit - all units' is 0.3 kPa. Hence the conclusion is that the capacity of the pump is sufficient (the norm is 2 kPa maximum).

The regulator is a 'weight' regulator and is placed between the interceptor and the vacuum meter, which is correct. For a fixed installation like ours one can use this type of regulator.

**Regulator test**

There are several types of regulators: spring, weight and sensor. Essential is that a regulator **prevents fluctuations** in the vacuum level, that it is **sensitive** and that it admits as much air as is needed by the installation.

First of all one must ascertain whether the position of the regulator is correct and whether it stands vertically (especially when it is a 'weight' regulator).

Before starting the test, the pump should be at working temperature; this requires about 15 minutes. The regulator test should be done at a vacuum level that is 2 kPa below the normal working level (2b, on the test form). The regulator is then closed. The air which enters before its closure represents the reserve capacity of the installation + air leakage in the regulator.

After the vacuum level has dropped by 2 kPa, the regulator only admits air through its leaks.

*Determination of the reserve capacity: Test nr.3*

This test should be carried out with all milking units and accessory parts in working order but with the teat cup liners closed off (with stoppers).

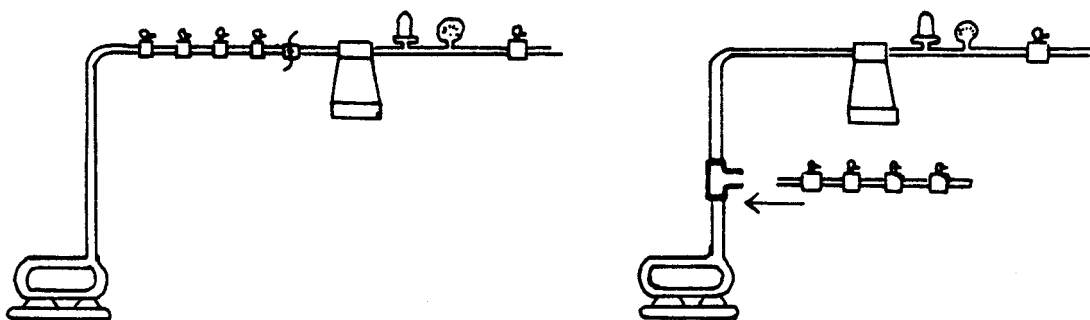

Figure 45:

The opening of the air-flow meter should now be adjusted in such a way that the pressure in the installation attains the test level (i.e. 2 kPa lower than the normal working level). This will close the regulator. Then read the float indicator of the air-flow meter and convert the reading into litres of air/minute. Next, compare the result with the norm (see table below).

If there is insufficient reserve capacity, milking cannot be carried out as it should because there will be too much pressure fluctuation in the installation.

A lack of reserve capacity may be due to leaks in the installation. If it is not due to leaks, the capacity of the pump is too low.

*Table 8: Norms for reserve capacity (after more than one year in use)*

number of milking units	bucket installation (litres/min.)	milk pipeline (litres/min.)
2	90	150
3	115	175
4	140	200
5	165	225
6	190	250
7	215	275
8	240	300
10	290	350
12	-	370
14	-	390
16	-	410

*Determination of the air consumption of the milking units: Test nr. 4*

Each milking machine unit consumes some air because of the pulsation chamber/claw air inlet; this air will enter the vacuum pipeline (and the milk pipeline); it should be continuously removed by the vacuum pump.

The most important air inlet is the pulsator. If the dustcap or air filter of the pulsator is blocked, the air consumption will be much lower, but this hampers the functioning of the pulsator and should be prevented.

First, determine the capacity of the installation as described under test nr. 3, but now without the milking units. Note the result, in% and in litres of air/minute.

Calculate the difference between tests nrs. 4 and 3. This difference corresponds with the air consumption of the milking units. It should not be more than 25 litres per bucket or 40 litres per milking unit of a milk pipeline installation.

*Determination of regulator leakage: Test nr. 5*

Determine the capacity of the installation, with the regulator closed off.

Note the result shown by the air-flow meter, in% and in litres of air/minute. Then calculate the difference between 5 and 4. This difference represents 'leakage' in the regulator.

Sometimes there may be more than one regulator in an installation. The total leakage should not exceed the recommended maximum. Worn-out seatings and/or valves, or dirt between seating and valve, are the main causes of leaks in a regulator.

*Determination of milk pipeline leakage: Test nr. 6*

First the actual capacity of the installation without the milk pipeline is determined and noted. Then the difference between tests 6 and 5 is calculated; this difference represents leakage in the milk pipeline.

Leakage may occur at the joints and the taps in the milk pipeline. It should never be more than 30 litres/minute.

### *Determination of vacuum pipeline leakage*

First determine the capacity of the pump just behind the pump. Note the result. Next calculate leakage in the vacuum pipeline (the difference between tests nrs. 7 and 6).

Leakage in the vacuum pipeline may occur at the joints and the taps. It should not be more than 5% of the capacity of the pump.

### *Capacity of the vacuum pump: Test nr. 7*

The pump should have sufficient capacity. Compare the test result with the performance as stated by the manufacturer.

See table on page 21.

Quite often the performance of a vacuum pump decreases considerably with use.

To increase the capacity of a pump, one should first count the number of revolutions per minute it makes (test nr. 8). Next, consider changing the pulleys in order to get more revolutions; this may only be done if it is within the pump's limits. If not, a more powerful pump should be bought.

### *Test nr. 8*

With a revolution counter, determine the number of revolutions/minute made by the pump, by placing the counter directly on the pump shaft for one minute.

Compare the result with the specification provided by the manufacturer.

### *Check on the air-flow in the pipeline(s): Test nr. 9*

For this test all 'vacuum-consuming' parts should be connected and operational. With the mercury column, measure the vacuum at the beginning of the line (behind the pump) and at the end.

Then calculate the difference (b-a); this difference should not be more than 2½ kPa.

The difference is due to friction losses in the installation; the vacuum near the pump is stronger than that at the end. Narrow pipes, long distances, many bends and cross tubings, and water and dirt in the line(s), all increase the fall in vacuum level.

If the vacuum pipeline has two dead ends, both ends should be measured separately.

**An example of a test result, based on reality** (continuation of page 76):

The air-flow meter used is the Fischer/Porter; 1% on the flow meter is in reality 3.1/5.6/7.0/12.9/15.4 litres of air per minute. In our case **7.0** litres.

$$2b = 53.2 \text{ kPa} - 2 \text{ kPa} = 51 \text{ kPa}$$

P = vacuum pump      R = regulator  
VP = vacuum pipe      L = milk pipeline

*Table 9:*

Test Programme		air-flow		norms	remarks	
		%	litres/min.			
3	P + VP + R + L + 4 milking units (reserve capacity)	30	210	140 litres	see table reserve capacity	
4-3	air consumption of milking units and accessory parts		56	30 L/unit	normal	
4	P + VP + R + L (capacity without milking units)	38	266			
5-4	regulator leakage		266	8% of pump capacity (max. )	too large	
5	P+VP+L (capacity without regulator)	76	532			
6-5	milk pipeline leakage			20L/min. (max. )		
7-6	vacuum pipeline leakage		36	5% of pump capacity (max.)		
7	P (pump capacity)	84	588	700 litre	see specification of manufacturer	
8	revolutions/min. of the pump	850 T/min				
9	pressure difference over 50 m pipeline	a	b	b – a=c	norms	remarks
		level in kPa at the end	level in kPa at the beginning			
	1st pipeline	49.5	50.8	1.3	2 (max. )	correct
	2nd pipeline	-	-	-		

**Comments**

*Test nr. 3*

The test is done with all milking units and all other parts functioning. The air-flow meter indicates ‘30’; with our meter ‘30’ should be multiplied by ‘7’ = 210 litres/min. in reality.

The norm for the reserve capacity with 4 milking units is 140 litres, hence we may conclude that the capacity of the pump is sufficient for our installation.

*Test nr. 4*

If one takes away the milking units, it is possible to determine the capacity of the installation itself (test nr.4). The calculation is that of test nr. 3 i.e.  $38 \times 7 \text{ litres} = 266 \text{ litres}$ .

With the results of tests nrs. 3 and 4 it is possible to calculate the air consumption of the milking units.

The difference between 3 and 4 is  $266 - 210 = 56 \text{ litres}$ . To find the air consumption per unit, 56 should be divided by 4 (units), which gives 14 litres. We may conclude that the milking units do not consume too much air, because the norm is 30 litres (max).

*Test nr. 5*

The capacity of the installation is determined with the regulator removed. The result is  $76 \times 7 = 532 \text{ litres}$ .

The regulator leakage is the difference between tests nrs. 5 and 4; hence  $532 - 266 = 266 \text{ litres}$ .

The norm is ‘not more than 8% of the pump capacity’, which is  $588 \times 8\% = 47 \text{ litres}$ . The conclusion is that our regulator should be replaced because its leakage is far too high!

#### *Test nr. 7*

Leakage in the vacuum pipeline can be calculated after the capacity of the pump has been determined (just behind the pump, test nr. 7).

In our case this gives  $84 \times 7 = 588$  litres. Leakage in the vacuum pipeline is the difference between tests nrs. 7 and 6; hence  $588 - 532 = 66$  litres. The norm is 5% of pump capacity (max.), hence  $588 \times 5\% = 29$  litres.

The conclusion is that there is too much leakage: pipeline and taps should be repaired.

The capacity of our pump is actually 588 litres. According to the manufacturer the capacity should be 700 litres. One may conclude that the pump is worn out !

#### *Test nr. 8*

The number of revolutions of the pump is 850/min. This is in agreement with the manufacturer's specifications.

#### *Test nr. 9*

The air-flow test shows a difference of 1.3 kPa. The norm is 2 kPa (max.); the conclusion is that the air-flow in the installation is within the norm, but a cleaning operation would certainly be in order !

### **Pulsator test**

After working for a long time, a pulsator may no longer function properly.

A malfunctioning pulsator may cause problems (mastitis; milking takes too much time; teats are damaged).

The following tests of the pulsation system should be carried out:

- number of pulsations per minute
- limping (only with alternating systems)
- the pulsation curve (see page 34)

It is difficult to say which is the best pulsation curve. Nevertheless it can be said that the **b** and **d** phases should be clearly defined, with a minimum of respectively 30% and 15% of the duration of the cycle.

Especially on farms with mastitis problems it is important to keep a check on the pulsation curve.

**Example of test result** (continuation of page 80):

Make of pulsation system : **Pulsall**  
 Type : **JA 100**  
 Alternating/Simultaneous : **alternating**  
 Amplifier yes/no : **no**  
 Vacuum level : **53kPa**

Test programme	Pulsator number		
	1	2	etc.
10 number of pulsations per minute	60		
11 limping test	3%		
12 vacuum increase (a)	7.1	10.1	
13 max. vacuum (b)	66.6	66.6	
14 suction period (a+b)	73.7	76.7	
15 vacuum decrease (c)	7.1	4.1	
16 min. vacuum (d)	19.2	19.2	
17 resting period (c+d)	26.3	23.3	
remarks on functioning of pulsation system	in order		

- manufacturer's specifications:

\* number of pulsations/min = 60  
 \* ratio suction/massage = 71.5 - 28.5  
 \* limping = -

- visual check of the installation: **the vacuum taps look faulty**

- remarks on the installation:

- repairs or modifications to be carried out: **repair (or replace) the regulator and renew the vacuum taps**

Figure 46:

**Comments**

The pulsator is tested with a special electronic test apparatus that registers the readings.

*Test nr. 10*

The pulsation rate is 60. This is exactly what it should be. Tolerances are:

➤ at 40 p/min., between 38 and 42 is o.k.

- at 50 p/min., between 47.5 and 52.2 is o.k.
- at 60 p/min., between 57 and 63 is o.k.

#### *Test nr. 11*

'Limping' is only possible in an alternating pulsation system and it is the difference in% between the suction phase (**a** + **b**) left and the suction phase (**a'** + **b'**) right. This difference may not be more than 5% of the duration of the cycle:

- at 40 p/min., max. permissible limping is 3.3%
- at 50 p/min., max. permissible limping is 4.2%
- at 60 p/min., max. permissible limping is 5.0%

#### *Test nr. 12*

The phase 'vacuum increase' (**a**) is 7.1 and 10.1 respectively. This is in order given the fact that it takes only a little time to reach a maximum vacuum.

#### *Tests nrs. 13 and 14*

The 'maximum vacuum' phase (**b**) is 66.6 and 66.6 respectively. This is rather long but the risk of udder congestion is limited because there are 60 pulsations per minute.

The suction period (**a** + **b**) is 73.7 and 76.7 respectively.

#### *Test nr. 15*

The phase 'vacuum decrease' (**c**) is 7.1 and 4.1 respectively. This is rather short but there is still sufficient time for the massage of the teats.

#### *Tests nrs. 16 and 17*

The 'minimum vacuum' phase (**d**) is 19.2 and 19.2. This is long enough for proper massage of the teats.

The ratio suction-massage ('resting') should be 71.5 - 28.5 (manufacturer). In reality on the left it is 73.7 - 26.3 (2% deviation) and on the right 76.7 - 23.3 (5% deviation).

The maximum permissible deviation is 5% (at 60 pulsations per minute). This means that our pulsator functions just within the norm (but not more than that).

At 50 p/min., the limit is 4.2% and at 40 p/min it is 3.3%.

The overall conclusion is that our pulsator is still functioning properly.

## **11.4 Further maintenance jobs**

At least **once a year** the following items should receive attention.

### **vacuum pump**

- cleaning of oil reservoir
- adding or draining oil
- cleaning of exhaust pipe
- tension of V-belt; replacement if necessary

### **vacuum regulator**

- cleaning of dustcap, valve and seating
- adjustment, if necessary

### **pulsator**

- cleaning
- new diaphragm in pulsators, if necessary



- greasing if necessary
- pulsations per minute; adjustment if necessary

#### **vacuum taps**

- renewing of faulty taps
- greasing

#### **milk taps**

- check condition of taps (repair if necessary)

#### **milk pump**

- check (and adjust) switching system
- install new sealing rings
- install new non-return valve
- install new rubber ring in joint near milk filter

#### **automatic cluster-removal equipment**

- override time control and adjustment (about 1.5 min)
- time delay (about 15 sec.)
- greasing of piston and ram

#### **feed supply equipment**

- control and adjustment

#### **repair damage to gates and doors**

**Room for additional remarks, illustrations, etc:**

## 12 The choice of a milking system

In principle, a milking session should not last longer than one and a half to two hours. One reason is that the attention (alertness) of a normal milker wanders if milking lasts longer.

Hence, to get the milking done within that period of time, with a given number of milking cows on the farm, one has to consider:

- how many stalls with milking facilities are needed?
- which system should be used: hand milking, bucket, milk pipeline, milking parlour?

The **number of milking cows** is related to the surface area of the farm and to the husbandry system that is practised. If calvings are well distributed over the whole year, about 85% of the total herd needs to be milked at any one time.

However, in the planning phase, one should also take (future) herd expansion as a possibility into account.

Normally, in Holland, a milking parlour is recommended when a herd exceeds 50 milking cows.

With respect to the **number of milkers**, one should take into account the maximum duration of the milking session and the milking system which is going to be applied.

Vacation days (weekly, yearly) and illness should not be overlooked; there should be ‘reserve’ milkers who can replace the ‘normal’ milkers when necessary.

Depending on the funds available and the preferences of the farmer, a costly or less costly system can be set up.

Much can be said about milking systems, stall facilities and dairy rooms. However, it is beyond the scope of this guide to go into details. Conditions differ so much (for instance, the climate, labour availability and costs) that it is almost impossible to treat this subject in a meaningful manner.

Our suggestion is to study guides such as ours, read articles, look around locally, discuss the matter with those who have opinions, consider costs and availability of materials and equipment, consider yearly costs and returns and, finally, to take decisions after very thoughtful consideration.

**The effects of wrong decisions will be felt all the time as milking takes place every day!**

**Room for additional remarks, illustrations, etc:**

## 13 Milk cooling = conservation

Milk as an agricultural product is quite unique as it is a liquid, heavy to carry around (85% is water) and almost instantly perishable (liable to spoilage).

Bacteria which are present in milk start multiplying as soon as milk leaves the udder of the cow. *Cooling* restrains the multiplication of bacteria and for that reason milk at the farm should be cooled down as rapidly as possible.

It is clear that in warm climate zones milk conservation at the farm is more difficult than elsewhere because of high ambient temperatures for several months in the year or throughout the year.

The following table shows the effect of cooling on the length of time milk is conserved (does not spoil). Note that 12 °C is not a temperature that is easy to come by in warm climate zones and that above 12 °C milk spoils rapidly.

Table 10:

temperature	milk is conserved for
12 °C	12 hours
8 °C	evening + morning milk mixed, 8 to 12 hours
8 °C	12 to 24 hours
4 °C	24 to 72 hours

As we all know, *heating* is another way to cope with bacteria but at the farm, outside the household situation, heating is not normally carried out.

### 13.1 Relatively simple methods of cooling milk at the farm

See illustrations on the following page.

- Air cooling.** One of the oldest methods is to place milk in its container in the coolest available area (shade & draught). This is effective for evening milk in areas where nights are reasonably cool. The method can be improved by placing wet cloth over the outside surface of the container; this may provide some additional cooling from water evaporation. Milk cans and the like should not be left open when they are still in the cowshed, because fresh milk easily picks up bad smells (dung, poor silage).
- Water cooling.** In its simplest form fresh milk is placed in a container (preferably from metal, for faster heat exchange) into the coldest water available at the farm. An improvement is water running over the outer surface of the milk container; this water may be tap water or water from a well. A next step is a metal surface cooler with water passing through the inner side and milk flowing over the outer surface in a thin layer. Such a *plate heat exchanger* is very effective and widely used for water cooling in relatively large-scale dairy farming throughout the world.
- Ice cooling** with ice produced commercially. Generally fairly expensive and not particularly effective because it is not easy to get a rapid heat transfer from the liquid milk to the solid ice.
- Rotor cooling.** Relatively cool running water under pressure passes through a system of pipes inside the milk can. The pressure activates a rotor. The rotor stirs the milk and this accelerates the cooling.

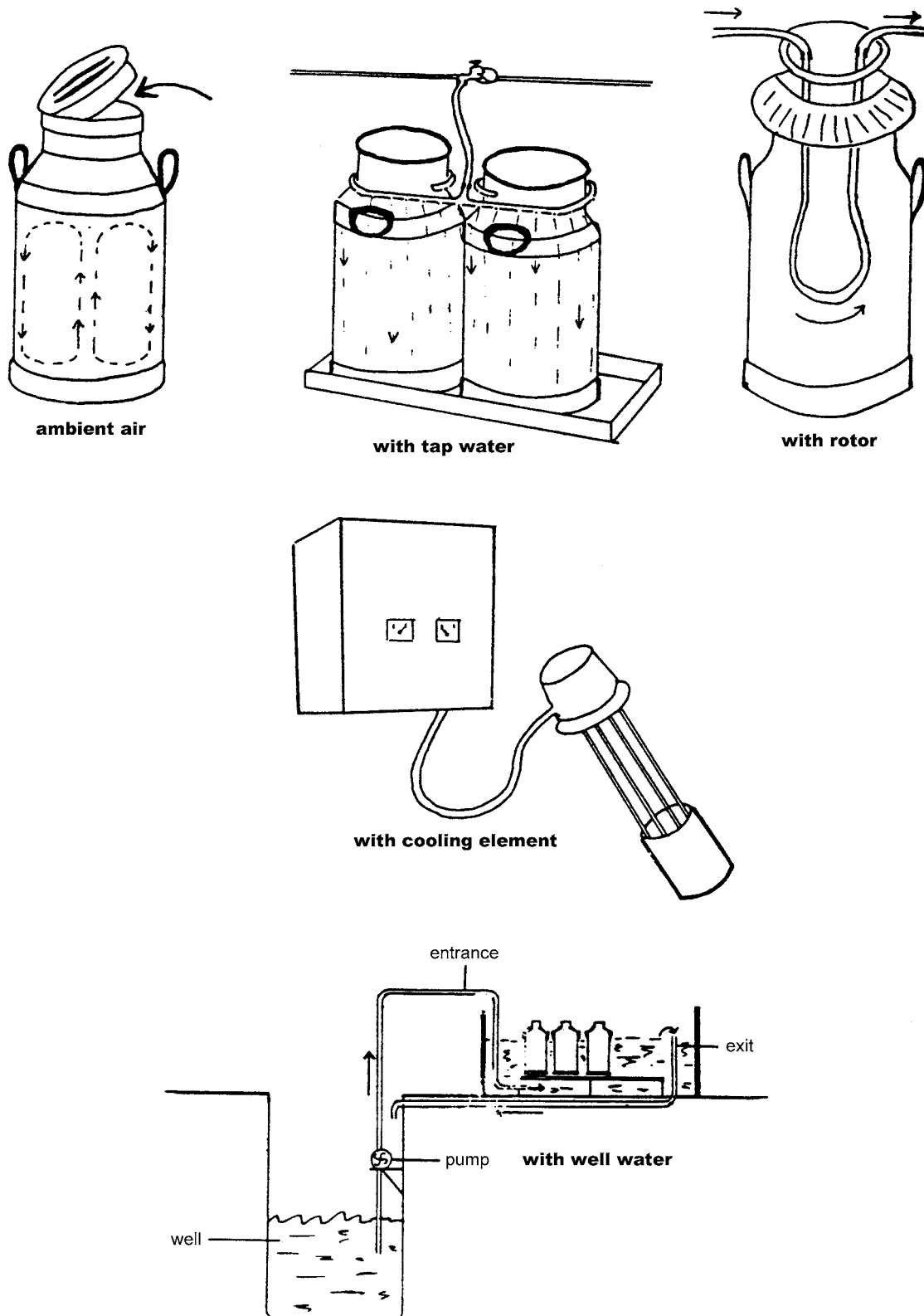

Figure 47: Cooling methods

### 13.2 Mechanical refrigeration (tank cooling)

The most effective means of arresting bacterial growth is to reduce milk temperatures to around 4 °C, as quickly as possible after milking, by means of *mechanical refrigeration*. This is widely applied in dairy farming in technically advanced countries.

In its most simple form it is milk placed into the domestic household refrigerator, which is practical for small amounts of milk.

Electric cooling with a cooling element is another simple version of mechanical refrigeration. Here a refrigerant liquid passes through an element that is introduced into the milk can. There is heat exchange and the milk cools down. Equipment exists with a rotor (for stirring the milk) and a thermometer.

The most widely used system in technically advanced countries and in large-scale dairy farming almost everywhere is the *direct expansion bulk tank*, ranging in size from 500 to 20,000 litres.

The working principle is **heat exchange** between two bodies, as before. Here the two 'bodies' are **the refrigerant liquid** and the **milk** in the tank.

The refrigerant is normally a chlorofluorocarbon (CFC) which evaporates easily. Its boiling point at atmospheric pressure is about minus 30 °C (water boils at +100 °C). The boiling point increases with rising pressure.

CFC is not corrosive, flammable or toxic and does not show temperature fluctuations. A kind of CFC should be used that is **not** harmful to the atmosphere's ozon layer.

In the following text the CFC will be called 'freon' (a trade name).

Freon evaporates in the milk tank (closed circuit). This process requires heat provided by the milk in the tank. In this way the milk is cooled.

There is a **compressor** in the system which draws the freon gas from the tank. This raises the temperature of the freon.

In the **condensor** (which has a ventilator) the freon gas cools down and becomes liquid again. Cooling continues due to pressure decrease and the cycle starts again (with evaporation in the milk tank).

In fact, the heat of the milk has been taken away by the air current created by the ventilator of the condensor.

The diagram illustrates the working principle of freon cooling.

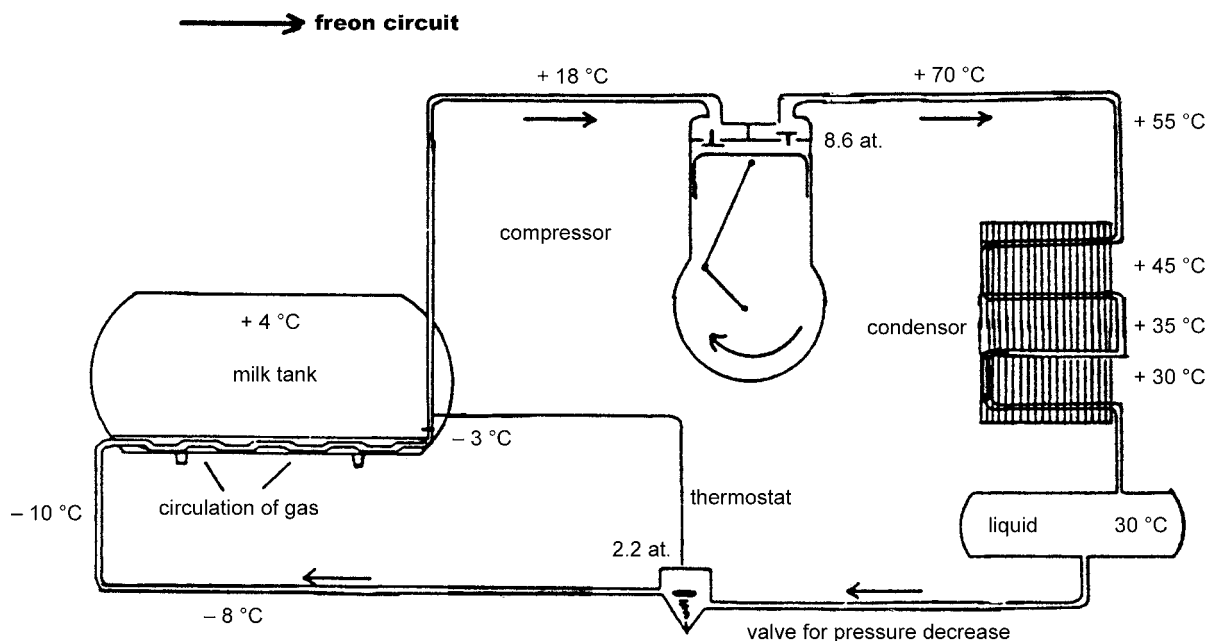

Figure 48: Working principle of freon cooling

The maintenance of mechanical refrigeration equipment should only be carried out by properly trained and experienced personnel. If this personnel is not available the installation of such equipment does not make sense.

Any breakdown or malfunction of refrigeration equipment must be attended to almost immediately or the value of the investment will be at risk.

An adequate supply of spareparts should be included in the installation.

Also an adequate supply of refrigerant (freon) should be assured.

Manuals should be provided containing a full and detailed explanation of the operation and maintenance of the equipment.

Electric power from the grid should be guaranteed. If not, a standby generator has to be installed, probably together with high and low voltage protection equipment.

There is a **compressor** in the system which draws the freon gas from the tank. This raises the temperature of the freon.

In the **condensor** (which has a ventilator) the freon gas cools down and becomes liquid again. Cooling continues due to pressure decrease and the cycle starts again (with evaporation in the milk tank).

In fact, the heat of the milk has been taken away by the air current created by the ventilator of the condensor.

Tank cooling by means of freon is quite effective and practical, for relatively large quantities of milk. But it requires reliable electric power (without power cuts!).

The milk in the tank can be conserved in this way for 2-3 days.

The freon is in indirect contact with the lower interior wall of the tank (a 'double' wall) and the milk is cooled down by contact with this wall because inside the tank the temperature of the freon is about  $-5^{\circ}\text{C}$ . It is necessary to have a **rotor** in the tank so that the milk near the cooling surface does not freeze.

To economize on energy, it may be possible to cool the milk down with (relatively cool) running water, from  $35^{\circ}\text{C}$  to about  $20^{\circ}\text{C}$  or even lower, before the milk enters the tank.

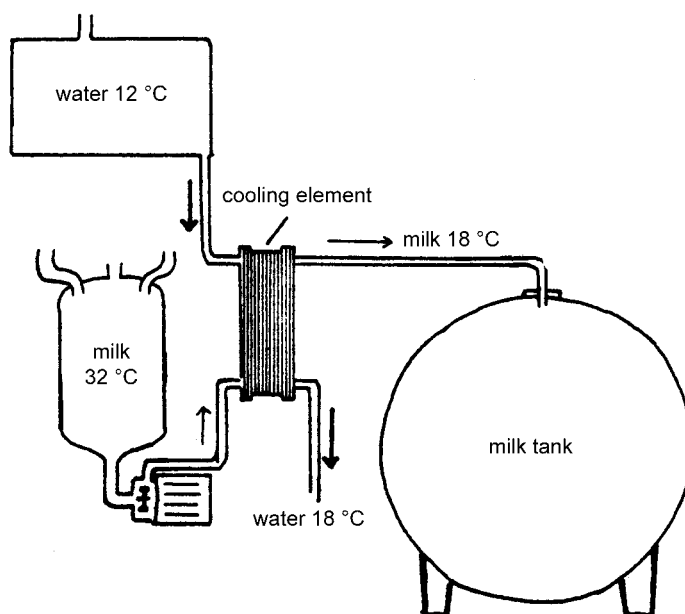

Figure 49: Water cooling before milk enters tanks

Different models and types of cooling tanks are available. The way in which the tank is cleaned is a point to consider.

Another important point is energy consumption. Try to make it as low as possible under the prevailing conditions; extra investments should be carefully weighed off against lower energy bills later on.



The milk in the tank should never freeze (become solid); the stirring mechanism inside the tank is important in this respect and should function properly under all circumstances.

Another very important point to consider is the **capacity** of the tank (minimum and maximum amounts of milk to be stored; possible expansion in the future).

Before starting milking:

- is the tank spotlessly clean ?
- is the milk evacuation tap (drain) closed ?

The cooling system may be started as soon as the rotor touches the milk; not before, because of the risk of ice formation.

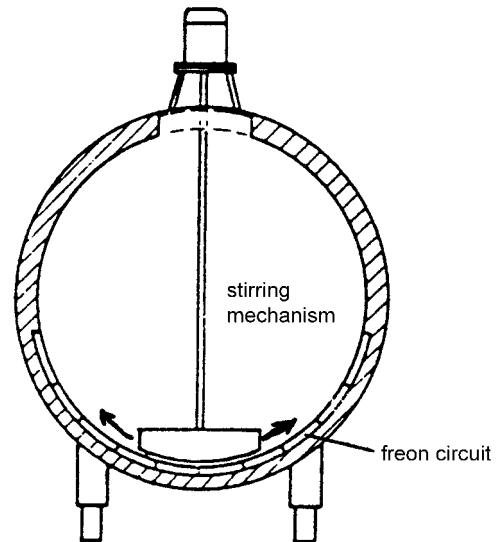

*Figure 50: Stirring to prevent freezing*

**Room for additional remarks, illustrations, etc:**

Under certain conditions preservatives harmless to human health may be used as an alternative method to conserve milk. However, milk preservatives are illegal in many countries.

Hydrogen peroxide is a preservative that has been known and used for a long time.

# 14 Milk : composition, quality and processing

## 14.1 The composition of milk

Milk is composed of a number of substances which are of great importance in (human) nutrition.

The following table gives an indication of the composition of the milk of common farm animals (in%):

Table 11:

	water	dry matter	fat	protein	milk sugar	salts
cow	87	13	4	3	5	1
mare	91	9	1	2	6	0
sheep	83	17	5	6	5	1
goat	85	15	5	5	4	1
camel						

It can be seen that the milk of different species of animals is quite different in composition.

The composition of **cow's milk** is not the same all through the lactation period.

Right after calving, the milk is called **colostrum** milk; an example of its composition is shown below:

Table 12:

	water	fat	protein	sugar	salts
at calving	66.5	6.5	23.5	2	1.5
after 12 hrs.	79	2.5	14	3.5	1
after 24 hrs.	84.5	3.5	7	4	1
after 48 hrs.	86	3.5	5	4.5	1

Colostrum milk should **not** be delivered to the milk factory. About 3-5 days after calving the milk will have reached its normal composition.

### The components of milk

#### Fat

The fat in milk is present in the form of very small (solid) particles. If the milk is left standing for some time (12-24 hours) without being stirred, the fat particles move towards the surface.

On the surface they form a **cream layer**, which can be removed and used to make butter. The fat gives the milk a slightly yellowish colour.

During the first few weeks after calving the fat content of the milk drops. Later, it gradually rises again; by the end of the lactation period the fat content is at its highest level.

The fat content of a cow's milk can vary from day to day.

Normally the evening milk has a higher fat content than the morning milk.

Feeding can also influence the fat content.

Furthermore, genetic factors are involved; one cow may give a higher fat content than another cow of the same herd.

There are also differences between breeds; e.g. milk from Jersey cows has a higher fat content than milk from Holstein cows (6 and 4% respectively).

In countries where the price which the farmer receives for milk is partly determined by the fat content, the latter directly influences the profitability of the farm.

The same goes for protein content.

### *Protein*

Protein in milk is also present in the form of very small particles. The protein content of the milk during a cow's lactation follows the same pattern as the fat content.

There is no marked relationship between the fat and protein contents of the milk of the same cow. In other words, a high fat content does not automatically mean a high protein content.

Genetic factors influence the protein content of the milk.

### *Milksugar (lactose)*

Milksugar is not present in the form of particles but is dissolved in the milk.

Milksugar gives milk its slightly sweet taste.

### *Salts*

Salts are also dissolved. Salts influence the taste of the milk.

Milk has a rather low iron (Fe) content. Calves fed only on milk may develop anaemia.

### *Vitamins and enzymes*

Vitamins are present in milk in very small quantities. Enzymes are chemical substances which facilitate certain chemical transformations.

One kind of enzyme (lipase) is of special concern to the farmer. It makes the fat in raw milk decompose into fatty acids which give a bad smell and a bad taste to the milk; they spoil the milk. Improper milking techniques or a poorly functioning milking machine can stimulate this process.

Enzymes cannot withstand high temperatures and they are destroyed when milk undergoes heat treatment in the milk factory.

### **Bacteria**

The quality of milk is largely determined by the number and types of bacteria present in the milk.

Bacteria consist of only one cell. They multiply by dividing into new cells. This process can be very rapid. Some bacteria need only twenty minutes to divide into two new bacteria.

In this case, after forty minutes there may be four bacteria, after one hour eight, after two hours sixty-four, etc. Hence, after four hours, one single bacterium may have multiplied to four thousand !

Milk is a very good medium for bacteria and in a relatively short time large numbers of bacteria can develop in milk, if it is not properly cooled. **COOLING THE MILK PREVENTS** the growth of most types of bacteria to a considerable degree. If it only needs to be stored for 12 - 18 hours, cooling to 8°C is good enough. If it has to be stored for one day or longer, cooling to 4 °C is necessary.

### *Main types of bacteria in milk*

Lactic-acid bacteria convert sugar into lactic acid, they render the milk 'acid'.

They are found everywhere: in the air, the cow shed, on clothing and on milking equipment (especially if not properly cleaned). Milk is easily contaminated with these bacteria and in milk they find very good growing conditions. In milk they develop rapidly, more than any other type of bacterium.

Lactic-acid bacteria do not make people sick.

**Coli bacteria** also convert milksugar, but not only into lactic acid. They also form gases.

Coli bacteria mainly live in the intestinal system of animals; hence they are present in faeces (cow dung for instance).

**Infectious bacteria** are commonly found in soil and water, but also on milking equipment which is not properly cleaned. In the latter case they can infect milk. They affect the protein and sometimes the fat in milk, giving it a bad flavour. They may be a threat to human health, for instance Brucellosis, Leptospira and tubercle bacteria.

**Butyric-acid bacteria** are commonly found in (poor quality) silage. When this is fed during milking, the milk will be contaminated. Therefore silage should only be fed after milking is finished. The presence of butyric-acid bacteria in milk causes problems if the milk is used for cheese-making. Even a few butyric-acid bacteria in milk are sufficient to cause problems.

**Mastitis bacteria** are present in milk when the udder of the cow is not healthy and has developed udder infection.

**HEATING THE MILK TO AT LEAST 80 °C KILLS** most types of bacteria.

On the farm, proper **CLEANING AND DISINFECTION OF THE MILKING EQUIPMENT** goes a long way towards preventing the development of large numbers of the above-mentioned bacteria. This is because on a farm the most important source of milk contamination is milking equipment that has not been properly cleaned and disinfected before use.

**Notes:**

- Dust or dried cow dung may contain as many as 1 billion bacteria per gram, just to give an idea of the numbers involved when speaking of bacteria.
- What bacteria need most of all is **moisture**. So do not look for bacteria on clean-looking equipment that has been ‘baked’ in the sun for some time. It is the combination of ‘dirt’ and ‘moisture’ which produces bacteria. Suspect places where they come together.

## 14.2 Milk quality

The notion ‘quality’ has several aspects. In the case of milk we may distinguish the following:

- 1 The **nutritional value** of milk (for humans).
- 2 **Safety**. A foodstuff should be safe for the person consuming it. The absence of disease-causing organisms and other harmful substances is very important in this respect. In the case of milk, great efforts should be made to prevent the entry of harmful bacteria and other substances when it is produced, and later, when it is stored and processed. If necessary, harmful bacteria should be eliminated during processing.
- 3 **Keeping qualities**. Milk should ‘last’ for some time, it should have a certain ‘keeping capacity’. Usually milk is treated one way or another, to improve its keeping capacity; for instance, ‘heating’ reduces the number of bacteria in milk. But the number of bacteria originally present in milk on the farm partly determines the properties of milk after heating; heating cannot change an originally poor product into quality milk.
- 4 **Processing qualities**. Fresh milk can easily be processed. Spoiled milk gives great problems.
- 5 **Sensorial properties**. A foodstuff should be ‘palatable’ (attractive) to the consumer and it should ‘go down well’. In milk the fatty acids may decompose and give milk and its products a more or less distasteful flavour.
- 6 **Acceptability**. A foodstuff should be acceptable in the public opinion of a country. Generally speaking, milk as foodstuff for humans is accepted almost everywhere.

When a cow is healthy, particularly her udder, she produces milk of good quality.

There are practically no bacteria in her udder and the presence of harmful (foreign) substances in the udder’s milk is unlikely. The udder tissue around the milk cells (alveoli) in the udder only permits the passage of molecules including water, which are then transformed into milk components in the alveoli of the udder.

A great effort should be made to **MAINTAIN** the original high quality of the milk, during the milking itself and after the milk has been removed from the udder (farm transport and storage). But some ‘deterioration’ is unavoidable; particularly micro-organisms, dirt particles and some farm chemicals may contaminate the milk after it has left the udder. And improper treatment, transport and storage at the farm may also have a negative effect on quality.

Milk processing plants (and milk collection centres) normally set **quality standards** for milk that is delivered.

The following quality tests may be carried out:

- the number of bacteria (TPC, total bacteria plate counts)
- the presence of Coli bacteria (culture)
- the presence of dirt in the milk and the smell of the milk
- the number of somatic cells in the milk (mastitis)
- the presence of antibiotics
- the presence of residues of detergents and disinfectants; or other substances which may have been intentionally added to the milk by the seller
- the presence of pesticides

Not every milk processing plant will carry out all the above-mentioned tests and it goes without saying that a quality test of the milk of every individual farmer cannot be carried out every day. Normally, (partial) tests are done every two, three or four weeks.

If milk does not pass the tests in one way or another, processing plants in many countries pay a lower price for that milk over the entire test period (two to four weeks). This will affect the farmer’s income and will presumably stimulate the farmer to try to deliver good quality milk next time.

Moreover, the processing plant (interested as it is in obtaining good quality milk) may send someone to check the farmer’s way of milking and cleaning and to advise on improvements. This is in the interest of both the farmer and the milk processing plant.

### **What can the farmer do to deliver good quality milk ?**

#### **1 If the milk contains too many **bacteria**.**

First of all the farmer should consider where the bacteria may come from (remember what has been said about moisture) :

#### **dirty:**

- udders
- milking stalls
- cows (long hairs, dung)
- working clothing, hands of milker(s)
- milking equipment (not properly cleaned and disinfected)
- feed remains
- surroundings and conditions, in general

Think especially of the milking equipment.

In order to prevent contamination of the milk, the following precautions should be taken:

- The cow, and especially her udder, should be clean. Shaving the udder twice a year is good practice.

- Washing the entire udder before milking, using clean udder towels and clean water (containing udder wash), can be recommended. The towels used for cleaning the udder should be washed out properly every day.  
The use of paper tissues for drying (a clean one for each cow) is advisable.
- It is also good practice when milking commences, to discard the first one or two squirts of milk, in order to remove bacteria which may have accumulated in the teat canal of each udder quarter.
- The milker's clothing and hands should be clean.
- The milking parlour, or the milking stalls should be clean.
- The milking equipment should be cleaned according to procedures described elsewhere in this guide.
- Once again, using milking equipment that is not properly cleaned and disinfected is the main cause of high numbers of bacteria in the milk. Bacteria particularly like milk residues left in milking equipment.  
Disinfecting the milking equipment just before milking is good practice.

## 2 If the milk contains **dirt**.

The farmer should try to find out what kind of dirt is getting into the milk; e.g. hairs, pieces of skin, dung, sand, ticks and flies.

In order to prevent dirt from getting into the milk, the same precautions must be taken as under a).

Apart from this, there are a few more points to bear in mind:

- The use of a good milkfilter, so that floating dirt is filtered out (ticks, flies, sand, etc.)  
But keep in mind that bacteria and harmful substances dissolved in milk are **not** retained by a filter! and 'floating dirt' should never have entered the milk. A milk filter (milk strainer) is there for 'incidents'.
- Do not stir up dust during milking by sweeping with brooms.
- In machine milking, the cow may sometimes kick off the teat cups. A clean milking stall prevents the teatcups from falling into faeces before they are reconnected.
- Store the milking equipment in a dirt-free place.

## 3 If the milk has a **bad smell and/or taste**.

This may be caused by the use of certain feedstuffs (e.g. wet brewers grains, silage of grass or maize, especially when of poor quality).

These feedstuffs should **not** be fed **before** milking but after milking is over.

## 4 If the milk has a '**cell count**' which is too high.

When the (somatic) cell count is too high (more than one million white blood corpuscles per cm<sup>3</sup>), it is almost certain that one or more cows have **mastitis**.

In this case the best thing to do is to check the cows individually. This can be done by making a cell count for each cow (at the milk processing plant) or by applying the so-called Californian Mastitis Test CMT (on the farm); as follows.

A special test plate is used, divided into four parts. Keep the handle of the test plate always in the same position (pointing towards the cow's tail), in order to know in which part of the test plate the milk of a certain quarter is present. Equal quantities of milk must be present in each of the four parts of the plate. Milk the cow's quarters directly into the plate.

Now a 10% T-pol solution is added to the milk, equal to the quantity of milk already present on the plate. Shake the test plate for 10-20 seconds.

Milk that becomes slimy comes from a quarter that must be suspected of being affected by mastitis.

Such quarters can be treated (see elsewhere in this guide).

## 5 If **antibiotics** are found in the milk

There are several ways in which antibiotics may get into milk:

➤ Cows, when dried off, are (sometimes) treated with antibiotics. These antibiotics are active in the udder for a period of about six weeks. If the cow calves before six weeks have passed, her milk will still contain antibiotics.

This milk should not be used for processing before the six-week period has passed.

➤ Mastitic cows are often treated with antibiotics. These antibiotics stay active for some days. The general rule is that milk from cows under treatment should not be delivered to the processing plant until 48 to 72 hours (4-6 milkings) **after** the last treatment. This includes the milk of quarters that were not treated, because antibiotics may pass from one quarter to another.

Always read the directions for the use of these antibiotics carefully !

➤ Cows which are treated with antibiotics for other reasons than mastitis may have antibiotics in the milk, even though the antibiotics were not applied to the udder but were given by intramuscular injection elsewhere, for example.

The milk of these cows should be kept separate for 24-36 hours (2-3 milkings).

## 6 If residues of **detergents** and/or **disinfectants** are present in the milk.

Farmers should keep themselves informed about the proper types of detergents and disinfectants to be used. They should take care to use these substances according to the directions and they should use the right quantities.

After using these substances, the milking equipment should be rinsed with plenty of water.

If detergents do get into the milk, the processing station should be informed. Such milk should be rejected for human consumption.

## 7 There may be **other harmful substances** in milk such as heavy metals, radioactive materials and toxic substances such as aflatoxine (produced by *Aspergillus flavus*, in feedstuffs). And milk may be colostrum milk or have undesirable flavours from feeds (from poor quality silage for instance).

### **Additional milk tests**

Sometimes milk processing plants apply further tests:

➤ for the presence of thermo-resistant bacteria in the milk;

➤ for the presence of blood in the milk;

➤ determination of the freezing/boiling point of the milk, or specific gravity, in order to find out whether water has been added to the milk.

Milk should not contain residues of **chemicals used in insect control** (flies, ticks or other insects). These chemicals may be a threat to human health.

Apart from this, it is important to have drinking water and feedstuffs that are not contaminated by **crop protection chemicals** in general.

Normally these chemicals are toxic to the animals; but they may also be a threat to human health when present in milk.

### *Alcohol test*

A milk processing plant may test the quality of milk by means of the alcohol test, which indicates the **stability** of the milk.



In the alcohol test, equal quantities of milk and alcohol (75%) are mixed. If the mixture becomes more or less solid (coagulation), the result is called positive and the milk in question is rejected. If the test is positive, the milk is too acid (pH lower than 6.2). Such milk is no longer 'stable' (this applies especially to its proteins) and will cause problems when processed. In fact, it is unfit for processing.

Milk can become **instable** as a consequence of:

- presence of large numbers of bacteria forming (lactic) acid in the milk
- presence of mastitic milk
- presence of residues of detergents and sanitizers

The addition of substances which raise the pH (by the seller, in order to pass the alcohol test !) renders the milk even more unsuitable.

#### *Temperature checks*

Persons handling milk before it is finally delivered to the processing plant, should regularly take the temperature of the milk. A temperature which is too high is one of the main causes of poor quality milk! Water-cooled milk should have a maximum temperature of 15 °C.

#### *Non-processed milk: the informal milk market*

As we all know, in many countries in the tropics, resource-poor consumers (and they are many) cannot pay the extra costs that processed milk incurs (pasteurization, packaging) and prefer to buy raw milk and boil it themselves, prior to consumption, mainly as an ingredient in other foods, mostly tea. In line with tradition, by the way. There is an informal market in non-processed milk: mobile vendors, milk bars and milk kiosks, giving employment to many people.

A recent survey by ILRI in Nairobi has shown that in Kenya, Tanzania and Uganda, some 80% of the milk produced is sold on the informal market as raw milk. The same applies to India, the world's largest milk producer.

In Kenya, preservation (refrigeration, chilling and boiling) is applied in the informal marketing chain, but about 30% of milk from all traders is not treated for preservation in any way. The use of chemical preservatives (hydrogen peroxide) is very limited.

Some conclusions from the above survey:

- consumers generally prefer whole raw milk, even those who can afford pasteurized milk
- more than half of the samples taken during the survey exceed bacterial count standards but nearly all consumers boil milk before consumption, eliminating any bacterial threat to health
- the shorter the marketing chain, the lower the bacterial count
- anti-microbial residues were found in many samples, and since they are not destroyed by boiling, they may pose a major long-term public health threat in milk
- findings from Ghana and Tanzania indicate similar results

#### *Chemical milk preservation*

In stead of the traditional hydrogen peroxide, the FAO presently recommends the use of the lactoperoxidase system (LPS) for chemical milk preservation, in circumstances where proper cooling by (electrical) refrigeration is not possible.

## **14.3 The processing of milk in the factory**

'Processing' is a general word. It may comprise removal of dirt, centrifuging, pasteurization, standardizing, sterilization and other treatments.

### **Removal of dirt**

The removal of (floating) dirt is done by a so-called cleaning (clarifying) centrifuge.

The dirt is separated from the milk by centrifugal force. In addition to this, the milk is passed through milk filters.

### **Centrifuging**

Centrifuging is done to separate the cream (fat) from the milk.

After separating the cream, the milk contains only about 0.1% fat. This milk is called **skimmed milk**.

Skimmed milk can be used for cheese-making. In this case, part of the cream has to be added again, because milk used for cheese-making should contain more fat than 0.1% (normally at least 3.3% fat is needed).

### **Pasteurization**

Pasteurization is a heat treatment. The milk is heated to 72-74 °C and kept at this temperature for (only) 15-20 seconds. This is enough to kill most of the bacteria. Some survive, however, and the spores of bacteria are not killed either.

But enough are killed to make the milk fit for human consumption or for further processing.

Pasteurized milk is not sterile and cannot be stored for a long period.

### **Sterilization**

Sterilization is also a heat treatment. The milk is heated to well over 100 °C for a few seconds only. By doing this, all bacteria and spores are killed.

Sterile milk is obtained, which can be stored over a relatively long period (at least eight weeks) without getting spoiled ('Long Life Milk').

### **Standardizing**

This is done to obtain liquid milk with a fixed fat percentage.

By adding skimmed milk to whole milk (about 4% fat or more), milk with a lower fat content can be obtained, e.g. 3.2% fat.

### **N.B.:**

The kind of processing done in a factory depends partly on the types of products it produces.

In any case, some sort of heat treatment (pasteurization or sterilization) is always applied.

### **The production of milk for human consumption**

Usually most of the milk delivered to the factory is transformed into pasteurized milk for human consumption.

After pasteurization, the milk is cooled down to about 4 °C. The milk, after pasteurization, is not completely free of bacteria, but it has been turned into a safe product, fit for human consumption.

The milk is bottled or put into cartons, which are properly closed, in order to prevent contamination with dirt, bacteria, etc.

**Pasteurized milk** keeps its natural flavour to a large extent. It cannot be stored for a long time and has to be kept in a refrigerator to prevent rapid spoiling (within a day). But even in a refrigerator, a pack or bottle will still spoil in a relatively short period (2-5 days).

**Sterilized milk** has the advantage that it can be stored for a long time without having to be kept in a refrigerator.

After opening the bottle or pack, it will not be sterile any more and must be consumed within a short time. Sterilized milk has lost most of the natural milk flavour.

## Milk products

Milk factories can produce a lot of milk products. For example: certain custards, chocolate milk, vanilla milk, yoghurt, condensed milk, butter, cheese and dried milk.

### *Butter*

Butter is prepared from the cream of the milk. The cream is separated from the milk by a centrifugal process and contains 30-40% fat.

The cream is pasteurized and then cooled to 8-13 °C. Sometimes the cream is made slightly acid by the addition of lactic-acid bacteria. This is done to facilitate the process of **churning** and to give the right flavour to the butter.

Churning the cream makes the fat particles cling together, thus forming butter.

The liquid left over after churning is called **butter milk**, a product used for human consumption.

If the churning is done properly, as much as 98% of the fat in the cream is found in the butter.

After churning, the butter is washed with water at a low temperature, in order to remove the butter milk.

The last thing to do is the so-called working of the butter, to turn the butter into a homogeneous mass.

After this the butter is ready to be packed and stored, or to be consumed.

Butter can be stored for quite a long time, provided that it is kept at a low temperature.

The composition of butter:

- fat 83%
- fat-free dry matter 1%
- water 16% (maximum).

### *Cheese*

There are many different types of cheese. They can be classified according to their fat content in the dry matter, e.g. 60+ cheese, 40+ cheese and 20+ cheese. They can also be classified by their water content (hard cheese with 40-50% water; soft cheese with more than 50% water).

It should be kept in mind, however, that in addition to water and fat, cheese has a high protein content.

Milk of a certain fat content is used, depending on the type of cheese that the factory wants to produce.

Some substances are added to the milk, to stimulate or to prevent certain processes (e.g. lactic-acid bacteria, nitric acid, calcium chloride).

After the milk has been brought to the right temperature (about 30 °C) with the additives present, the **coagulant** is added, in order to make the milk more or less solid. This takes about half an hour. The product formed in this way is called **curdled milk**.

The remaining liquid is called **whey** and contains most of the lactose. The solid part is called **curd** and contains the fat and protein. The whey is removed and the curd is put into so-called **cheese casks** with added salt for the flavour; in these casks the product is put under pressure for about four hours, to remove the last whey.

Then the cheese is put away in store rooms **to mature**. The maturing process can last from a few weeks to a few months, depending on the type of cheese that is wanted (fresh cheese, matured cheese).

The longer the maturing period, the stronger the flavour of the cheese.

**Whey** is cheap and can be used in calf rearing. It can partially replace milk (or a milk replacer).

### *Condensed milk*

Condensed milk is produced with or without sugar added. The common kind of condensed milk sold in the (sub)tropics contains sugar. It is prepared by adding sugar to the milk and partially evaporating the water. After this the product can be packed. It is always canned, never bottled.

Other kinds of condensed milk are processed differently.

The composition of condensed milk with sugar:

- fat 8-9%
- fat-free dry matter 20-22%
- sugar 43-45%
- water 25-26%

### *Milk powder*

Whole milk, skimmed milk or buttermilk can be used for the preparation of milk powder, depending on the kind of milk powder that is wanted.

The aim of making milk powder is to get a product that can be stored over a long period, without taking up too much space (100 kg of whole milk gives about 12 kg of powder).

The basic procedure is to evaporate the water in the milk; milk powder contains only 2-3% water.

It goes without saying that evaporation takes a lot of energy.

After evaporation of the water, the oxygen present between the milk powder particles must be removed in order to prevent oxidation of fat, which would spoil the product. This is done by removing the air in the powder container with a vacuum pump and replacing it by nitrogen gas.

When milk powder is canned, it can be kept over a long period, even in tropical climates.

Milk powder is often made in seasons of high milk production, when more milk is available than can be marketed.

Milk powder is easily traded and transported over long distances.

The European Union EU as a whole dominates the international trade in products like condensed milk (73%), cheese (55%) and whole milk powder (55%), whilst it is amongst the main exporters of butter (with 31% ranking second after New Zealand). Holland is a major dairy producer in the EU.

The EU Common Agricultural Policy (CAP) is a bone of contention. The export of large quantities of subsidized whole milk powder by the EU can be an obstacle in the development of dairy farming in countries importing the powder.