

AT MICROFICHE REFERENCE LIBRARY

A project of Volunteers in Asia

How to Build a House Using Self-Help Housing Techniques

Published by:

Office of International Affairs
US Department of Housing and Urban Development
Washington, DC 20410 USA

Paper copies are \$ 1.40; ask for stock number
023-000-00276-1 when ordering. Bilingual edition
in Spanish and English.

Available from:

Superintendent of Documents
US Government Printing Office
Washington, D.C. 20402

Reproduction of this microfiche document in any
form is subject to the same restrictions as those
of the original document.

HOW TO BUILD A HOUSE ...USING SELF-HELP HOUSING TECHNIQUES

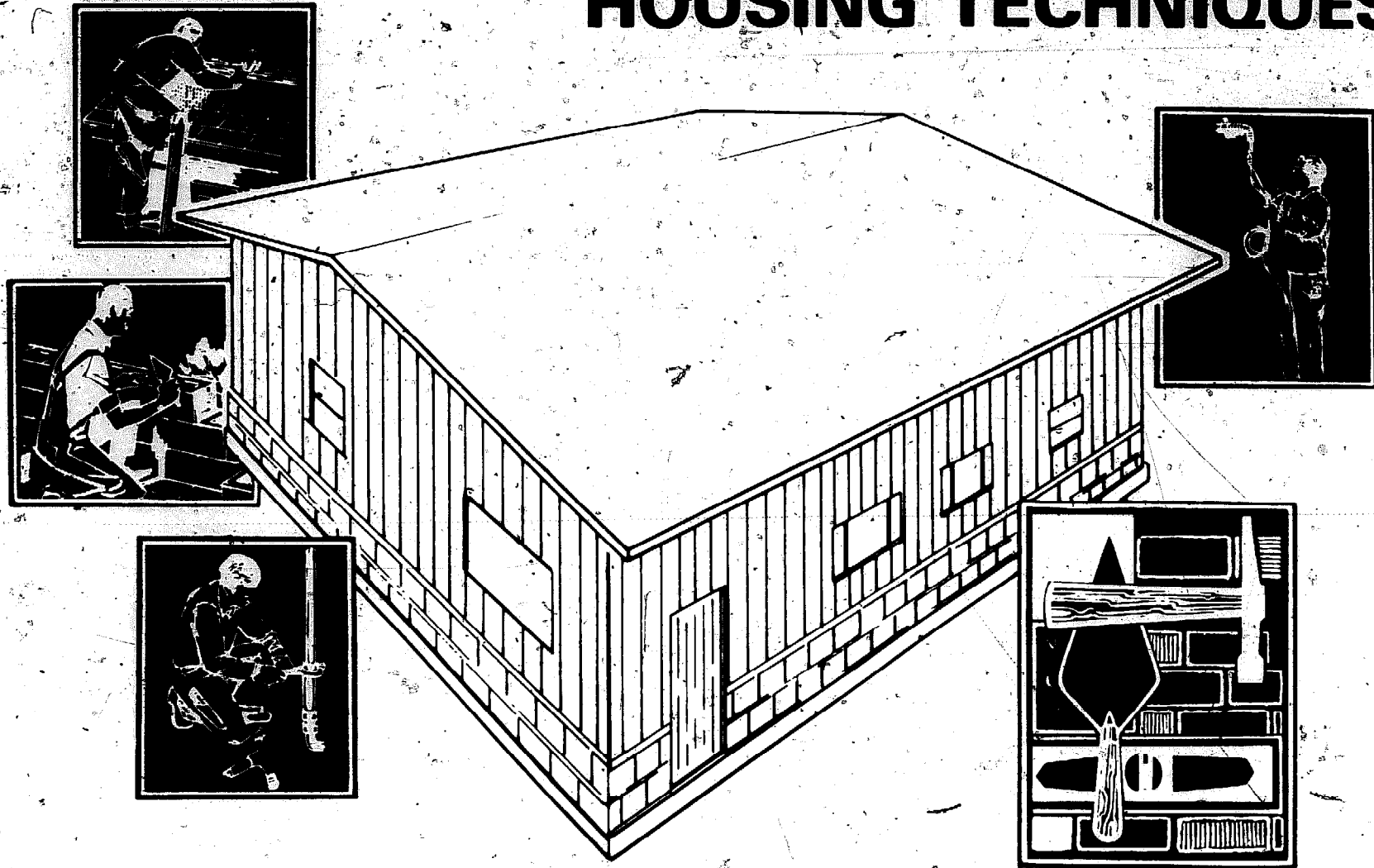

COMO FABRICAR UNA
CASA... USANDO TECNICA
AYUDA PROPIA

The Office of International Affairs, Department of Housing and Urban Development, has published this manual on self-help housing in the interests of the dissemination of information and knowledge of interest to U.S. domestic and other low income family needs. The techniques presented are not necessarily representative of construction in any given geographical area.

MAY 1974

For sale by the Superintendent of Documents, U.S. Government Printing Office
Washington, D.C. 20402 - Price \$1.40
Stock Number O23-000-00276-1
Catalog Number HH 1.6/3:H81/4

You can build your own house!

This manual is designed as a graphic means of demonstrating the basic methods and techniques used in building a home, whether it be a one room cabin or a more complicated dwelling with an electric, plumbing and sewage system. It has been conceived as a basic technology handbook for use by either individuals or groups of individuals who have the goal of building, or adding to, a home of their own, and for those involved in self-help home building or home improvement projects.

Much of the graphics material has been reproduced from a manual on the same subject produced by the Inter-American Institute for Housing located in Bogotá, Colombia, in collaboration with the National University of Colombia, and the Institute for Territorial Credit, the Colombian Government agency for the development of low cost housing.

¡Usted puede fabricar su propia casa!

Este manual ha sido diseñado con el objeto de demostrar en forma gráfica, los métodos y técnicas básicas que se utilizan en construir una casa; sea esta del tipo de cabaña de un cuarto o un tipo de vivienda más complicada - con electricidad, instalación de agua y sistema de alcantarillado. Este manual ha sido concebido como un texto básico y tecnológico para ser utilizado ya sea individualmente o por grupos de personas cuyo objetivo sea construir su propia vivienda, o ampliar en parte su propia casa, y para aquellos involucrados en proyectos de construcciones de viviendas - por auto-construcción - o de mejoramiento de viviendas. Gran parte del material gráfico ha sido reproducido de un manual que trata sobre la misma materia presentado por el Instituto Inter-Americano de Vivienda ubicado en Bogotá, Colombia, en colaboración con la Universidad Nacional de Colombia, y el Instituto de Crédito Territorial, la agencia del Gobierno de Colombia encargada de programas de desarrollo de viviendas de bajo costo.

TABLE OF CONTENTS
EL CONTENIDO

	Page Página	
Shelter Types	6	Tipos de Casas
Units for Rainy Climates	6	Casas en Clima Húmedo
Units on Sloped Terrain	6	Casas en Desnivel
Units for Hot Climates	6	Casas en Clima Caliente
Units Designed for Temperate Climates	7	Casas en Clima Templado
Units Designed for Hot and Humid Climates	7	Casas en Clima Caliente y Húmedo
Parts of a House	8	Los Cuartos de una Casa
Kitchen	8	La Cocina
Dining Room	8	El Comedor
Living Room	8	La Estancia
Bedroom	9	Las Camas
Bathroom	9	El Baño
The Drawing	10	El Plan
Laying Out A Building	11	Contorno de la Construcción
Squaring the Layout	11	Localización de la Casa
Layout-Levelling	12	Contorno y Nivelación
Staking Out the House	14	Apuntando y Localizando la Casa
The Foundation	16	La Fundación
Materials and Construction Methods	16	Materiales y Métodos
Equipment and Tools	16	Utensilios
The Walls	18	Los Muros
Brick or Cement Block Walls	19	Muros de Ladrillos
Village Brick Works	20	Para Hacer Ladrillos
Adobe Walls	22	Muros de Adobe
Making Adobe Bricks	23	Ladrillos de Adobe
Stone Walls	24	Muros de Piedra
Using Plaster to Finish Walls	25	Aplanado de Yeso
Windows and Doors	26	Ventanas y Puertas
Thresholds and Window Sills	28	Sardineles y Repisones

TABLE OF CONTENTS
EL CONTENIDO

	Page Página	
The Floors	30	Los Pisos
Concrete	30	Cimiento
Stone Floor	31	Piso de Piedra
Flagstone Floor	31	Piso de Piedra Laja
Wood Floor	32	Piso de Madera
The Roof	33	El Techo
Clay Tile Roof	34	Techo con Tojas de Barro
Aluminum Roof	35	Techo de Aluminio
Asbestos Roof	36	Techo de Asbestos
Thatched Roof	38	Techo de Zacate
Water Supply Systems	39	Agua Para Usos Domésticos
Water Purifications	40	Filtros Domésticos
House Plumbing	40	Instalación y Drenaje
Sewerage Disposal Systems	43	Alcantarillado-Letrinas
Septic Tank System	44	Sistema de Alcantarillado con Tanque Séptico
Household Septic Tanks	44	Tanque Séptico para Uso Doméstico
Outhouses and Latrines	46	Letrinas
Electrical Systems	47	Sistemas Eléctricos
Wiring Diagrams	47	Instalación de Alambres
House Wiring Layout	48	Sistema de Alambres para una Casa
Electrical Components	50	Componentes Eléctricos

Shelter Types

Tipos de Casas

Units for Rainy Climates

Casas para Clima Húmedo

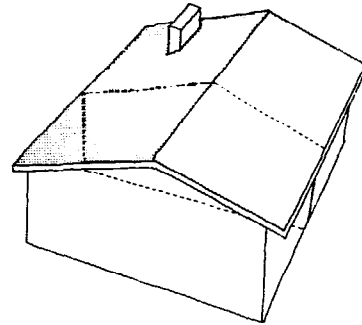

Units on Sloped Terrain

Casas en Desnivel

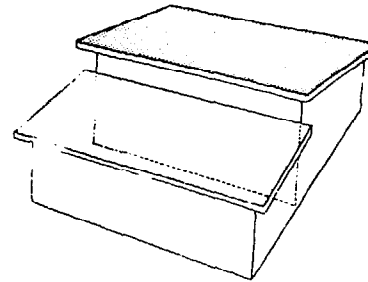

Units for Hot Climates

Casas en Clima Caliente

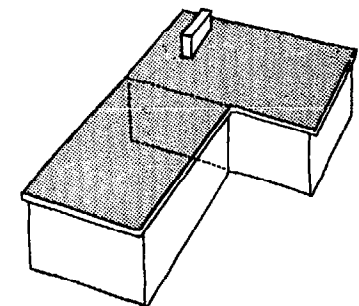
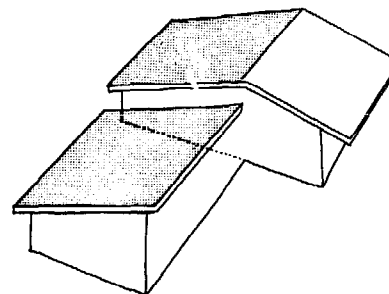
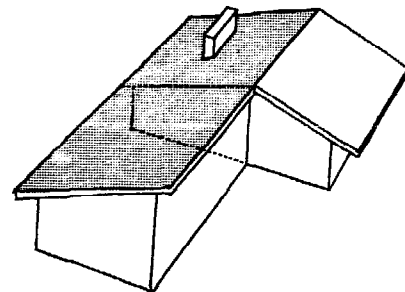
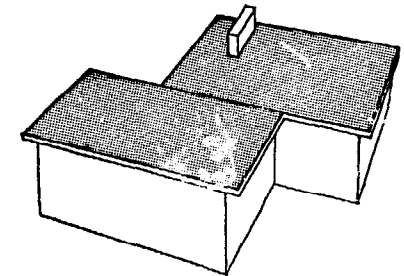
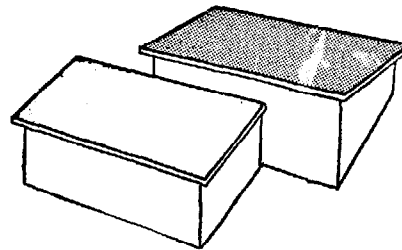
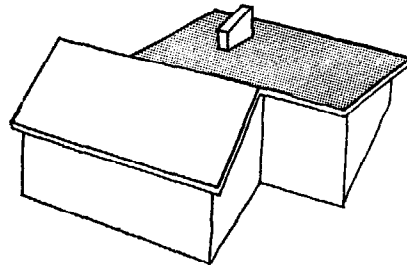
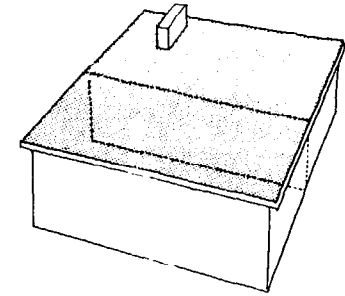

Units for Temperate Zones
Casas en Clima Templado

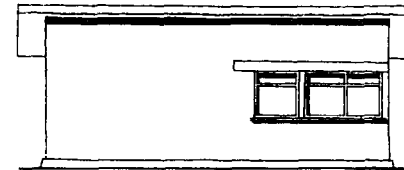
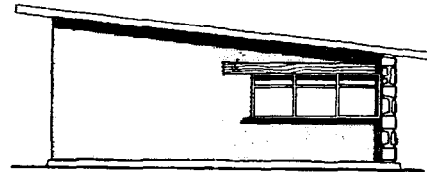
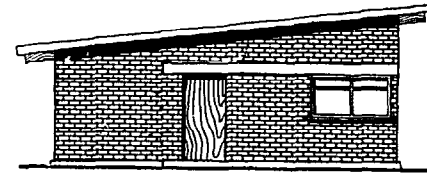
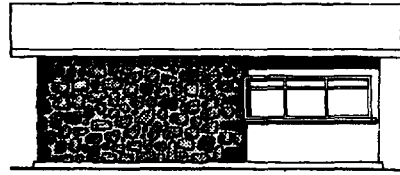

Units for Hot, Humid Zones
Casas en Clima Caliente Húmedo

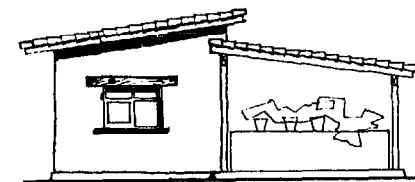
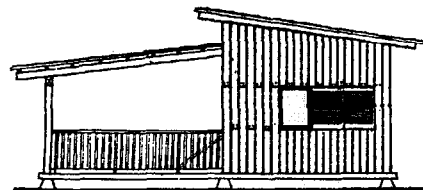
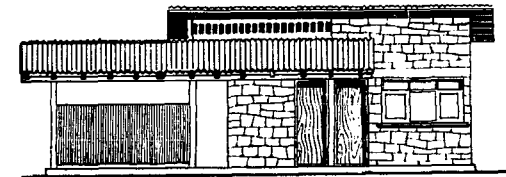
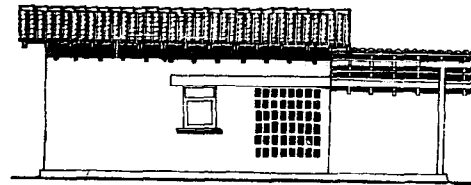

Parts of a House

Los Cuartos de una Casa

Kitchen
Cocina



Shows Space Required for Equipment and Circulation
Muestra del Espacio Necesario para Muebles y Circulación

Dining Room
Comedor

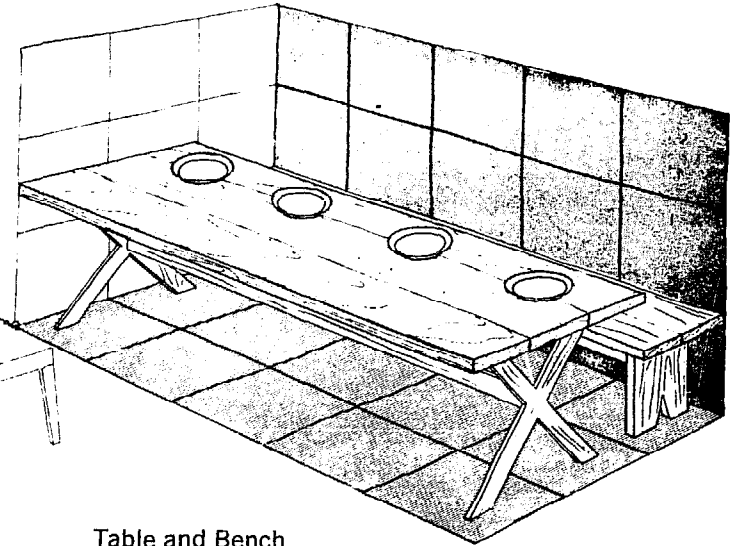
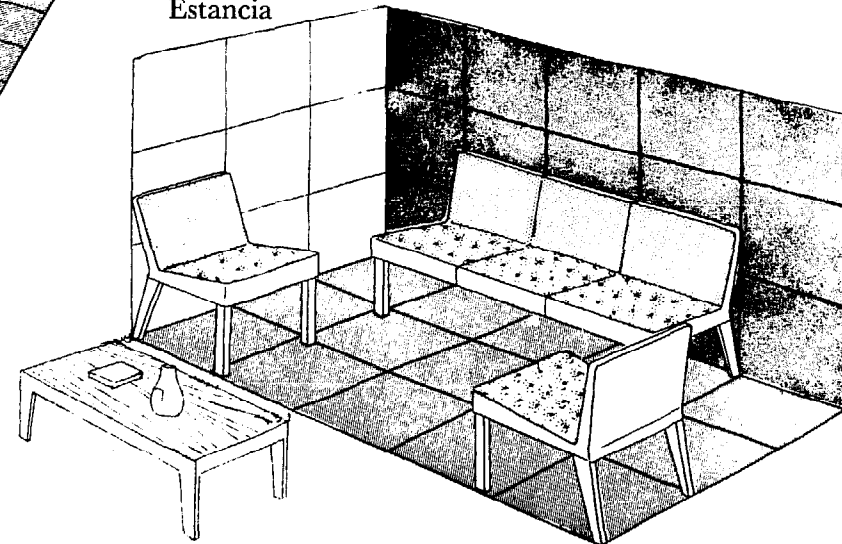

Table and Bench
Mesa, Banco-Silla

Living Room
Estancia



Couch and Table
Sofá y Mesa

Bedroom
Las Camas

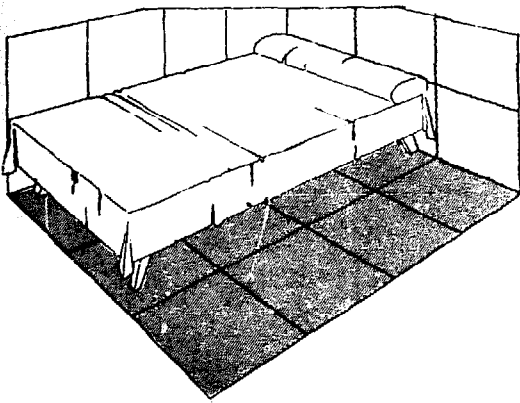

Single Bed Space
Espacio para Cama Individual

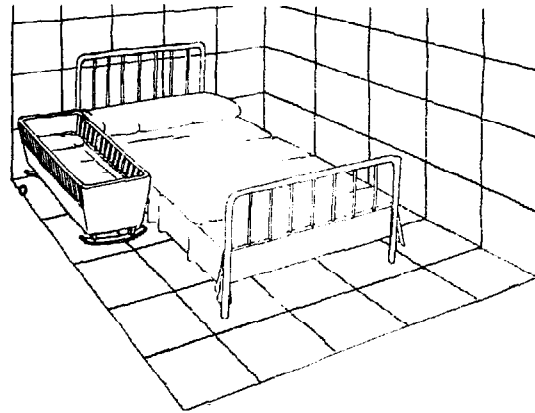

Bed with Crib
Espacio para Cama Mediana y Cuna

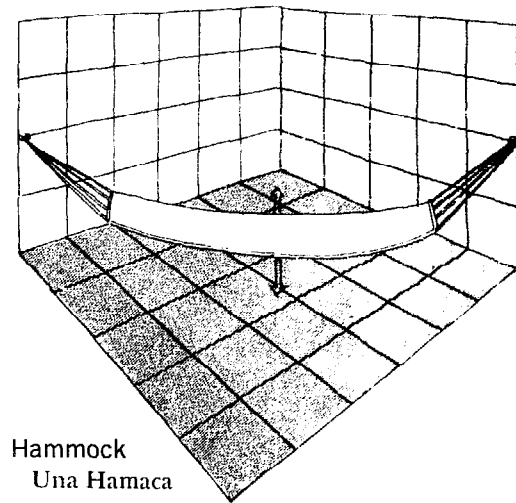

Hammock
Una Hamaca

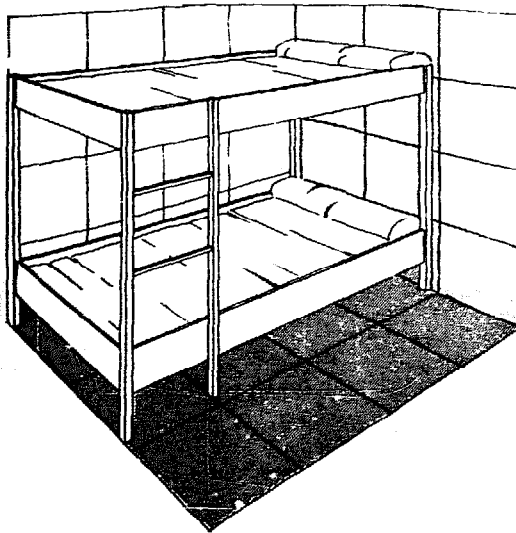

Bunks
Espacio para Dos Literas

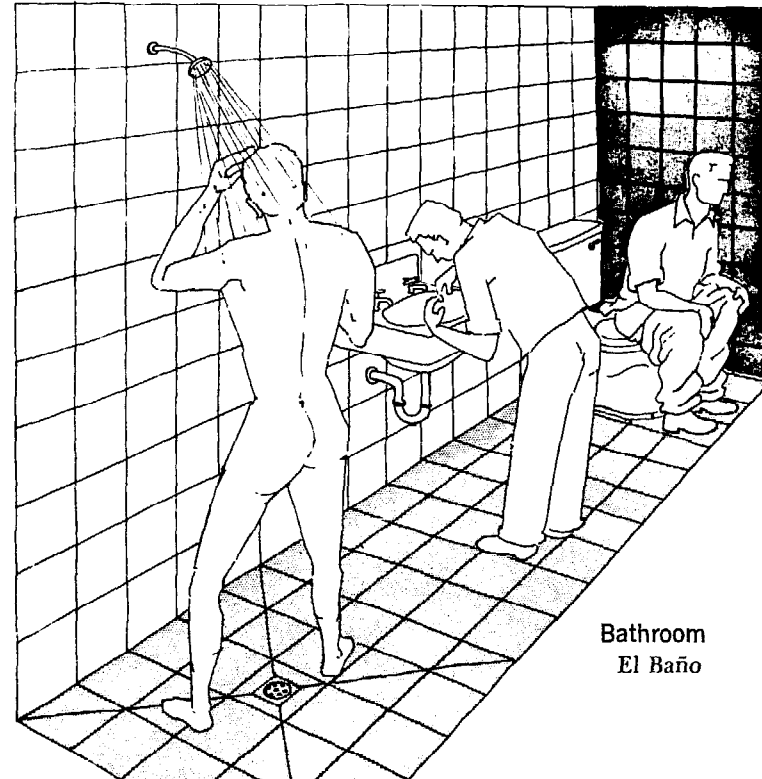

Bathroom
El Baño

The Drawing El Plan

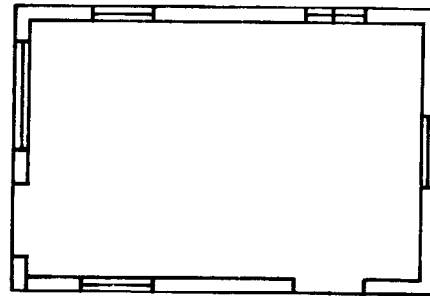
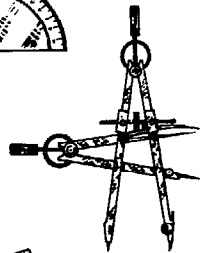
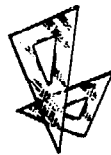
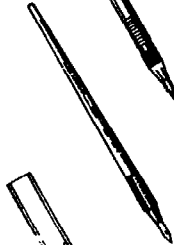
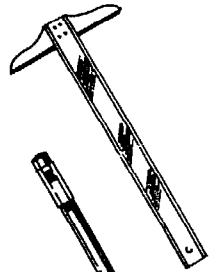

View from Above
Vista de Arriba

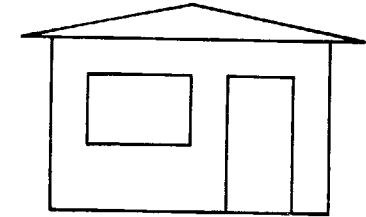

Side View (Left)
Vista de Izquierda

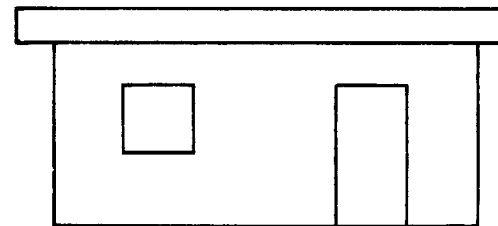

Front View
Vista de Enfrente

Layout and Levelling Contorno y Nivelación

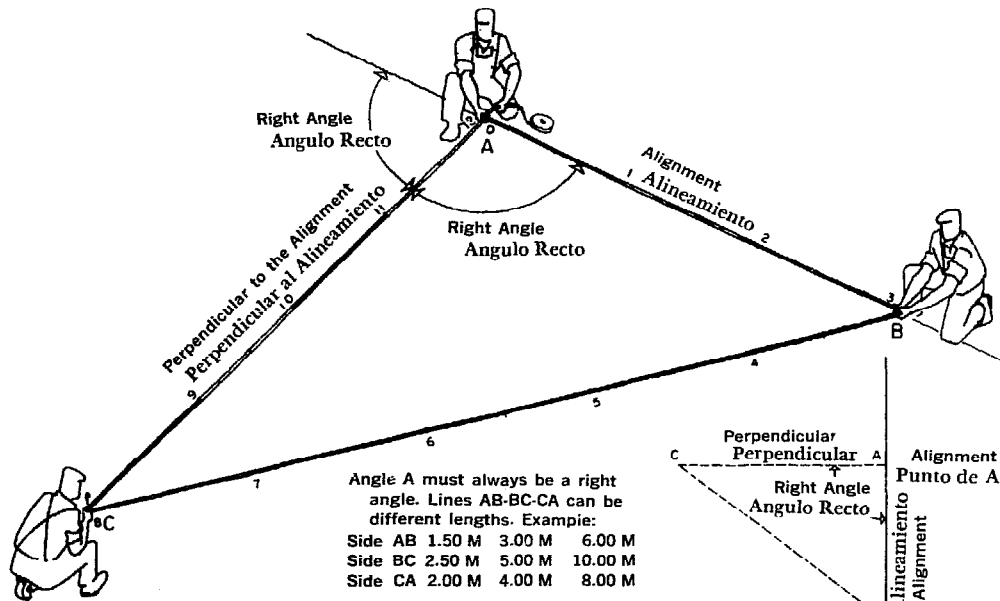

Angle A must always be a right angle. Lines AB-BC-CA can be different lengths. Example:
 Side AB 1.50 M 3.00 M 6.00 M
 Side BC 2.50 M 5.00 M 10.00 M
 Side CA 2.00 M 4.00 M 8.00 M

El ángulo en A siempre será recto. Las distancias AB-BC-CA pueden variar según convenga. Ejemplo:
 Lado AB 1.50 M 3.00 M 6.00 M
 Lado BC 2.50 M 5.00 M 10.00 M
 Lado CA 2.00 M 4.00 M 8.00 M

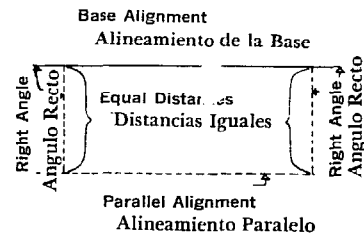
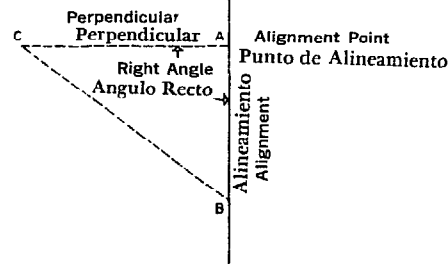

Tools Utensilios

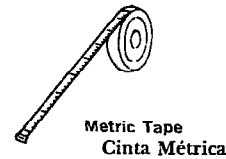

Establishing a level between two points

Nivelación entre dos puntos

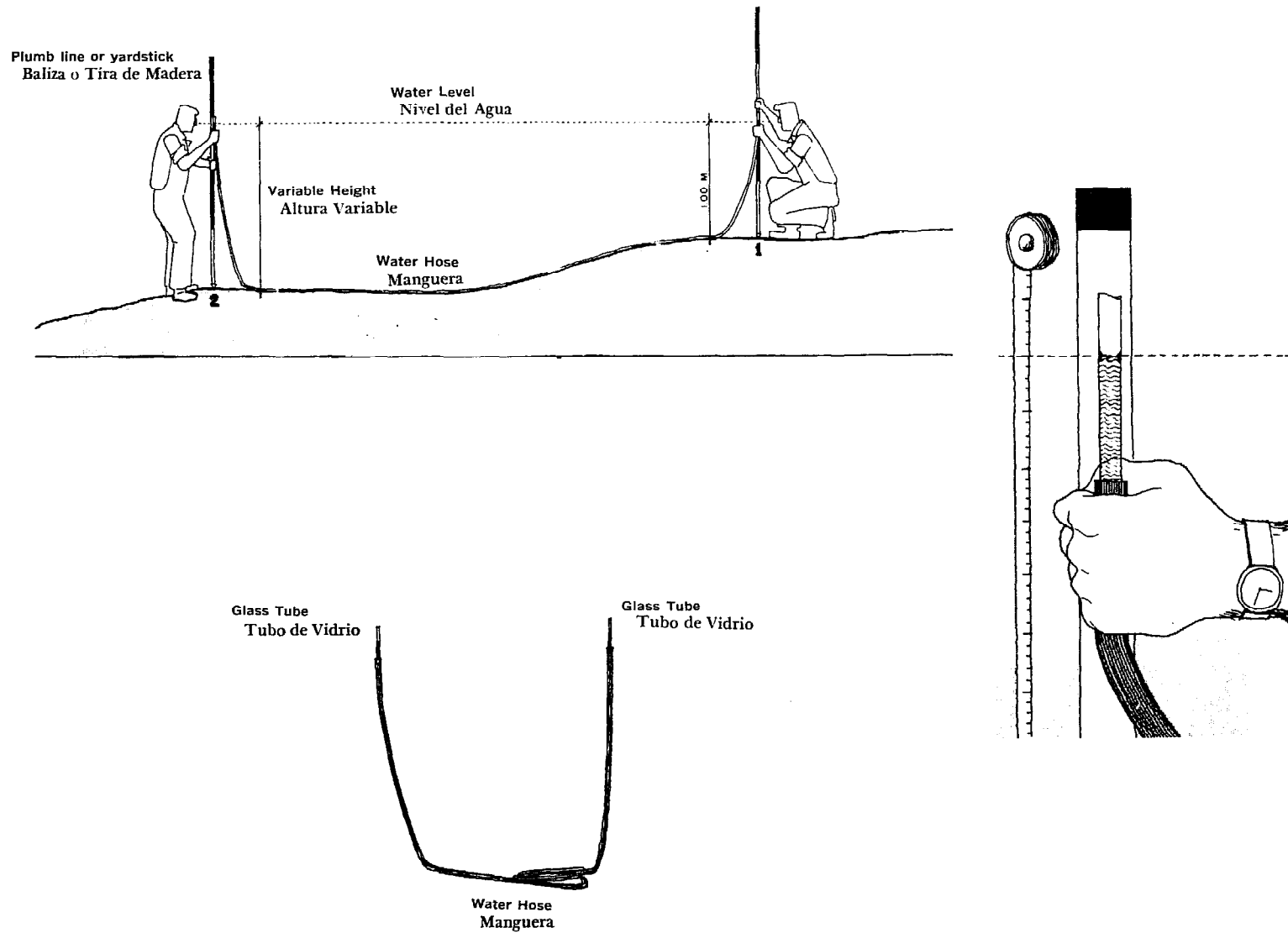

Staking and Laying Out the House
 Apuntando y Localizando la Casa

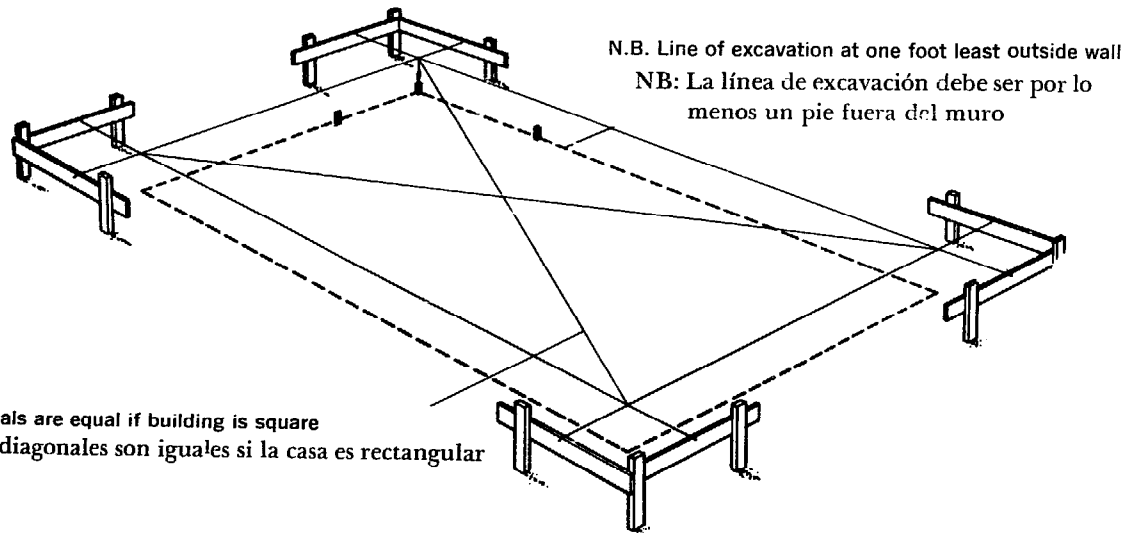

Diagonals are equal if building is square
 Los diagonales son iguales si la casa es rectangular

Outside line of foundation wall
 Línea externa de la fundación

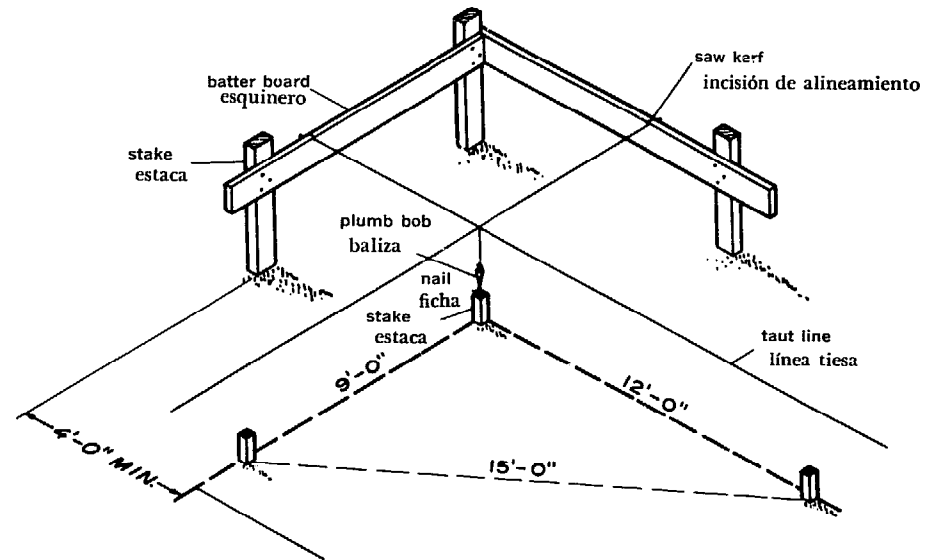

Establishing corners for excavation and footings

Estableciendo los rincones para la excavación y las bases

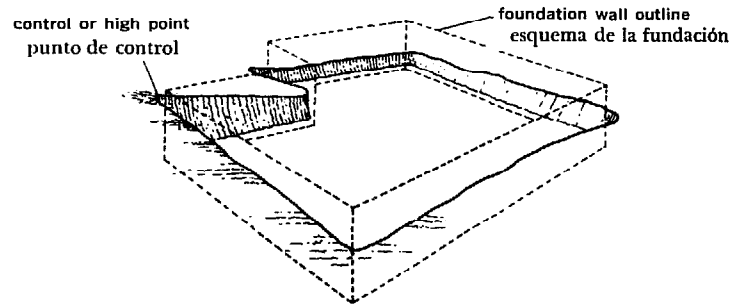
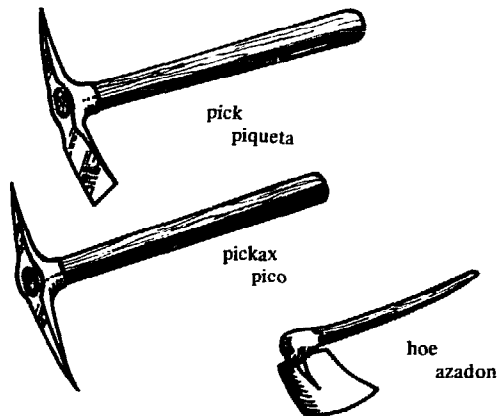
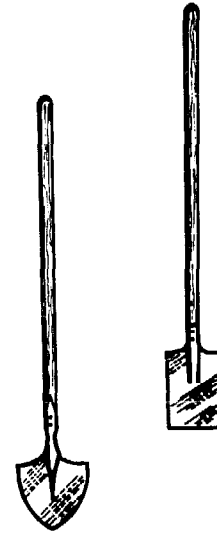
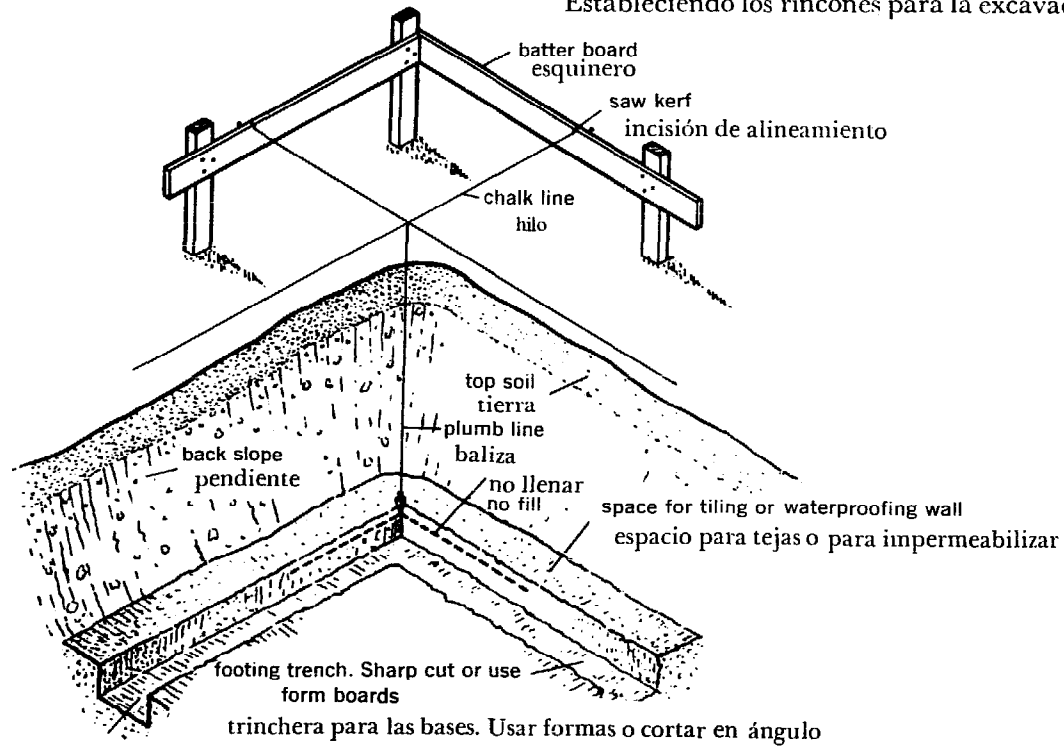

Establishing Depth of Excavation

Estableciendo la profundidad de la excavación

The Foundation La Fundacion

foundation wall made up of solid concrete blocks
muro contruido de bloques
de cimiento 20 cm anchos

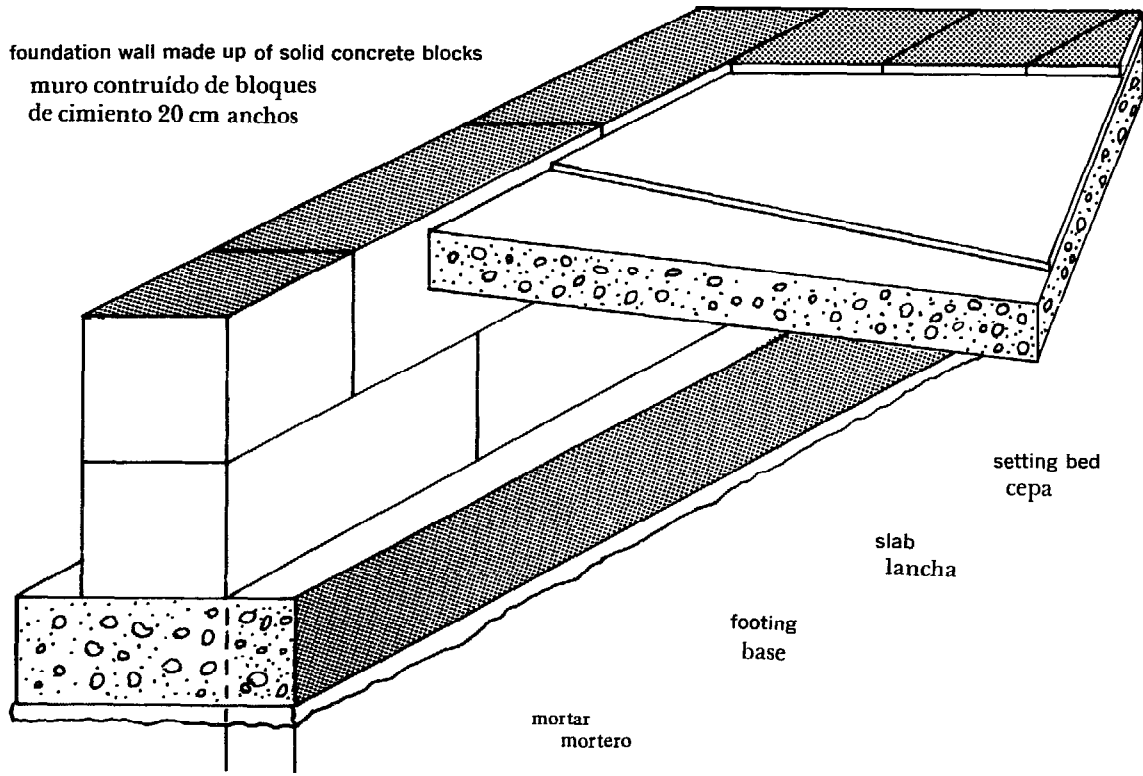

floor tile
losas

setting bed
cepa

slab
lancha

footing
base

mortar
mortero

sloped ground
terreno inclinado

a stepped footing
base de pasos

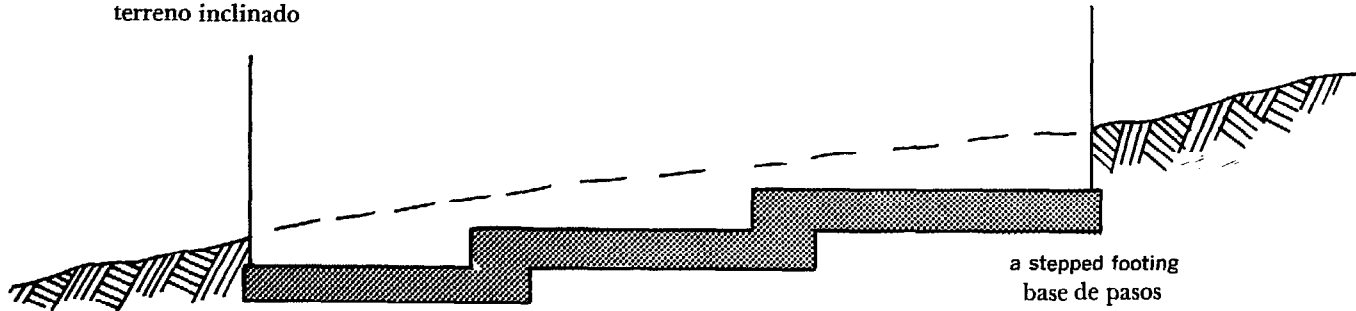
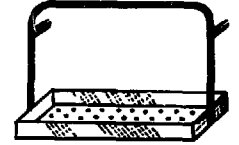

Reinforced Concrete
Cimientos de Concreto Armado

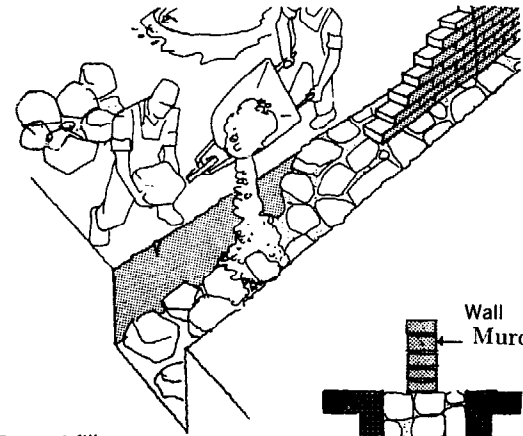
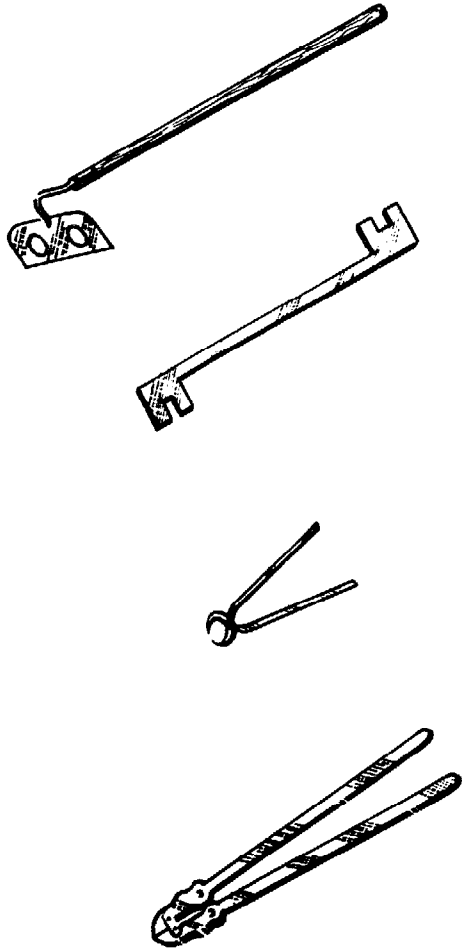

Cement fill
Cimientos de concreto ciclópeo

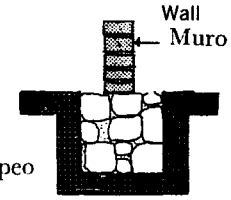

Cross Section
Sección

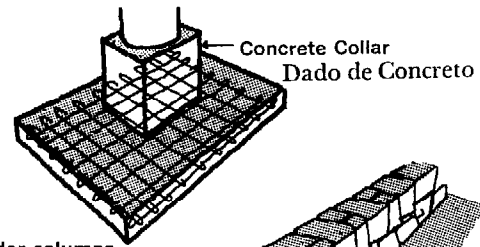

Under columns
Bajo columnas

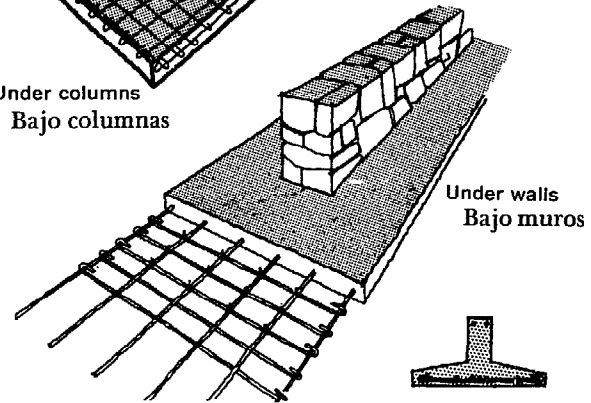

The Walls

Los Muros

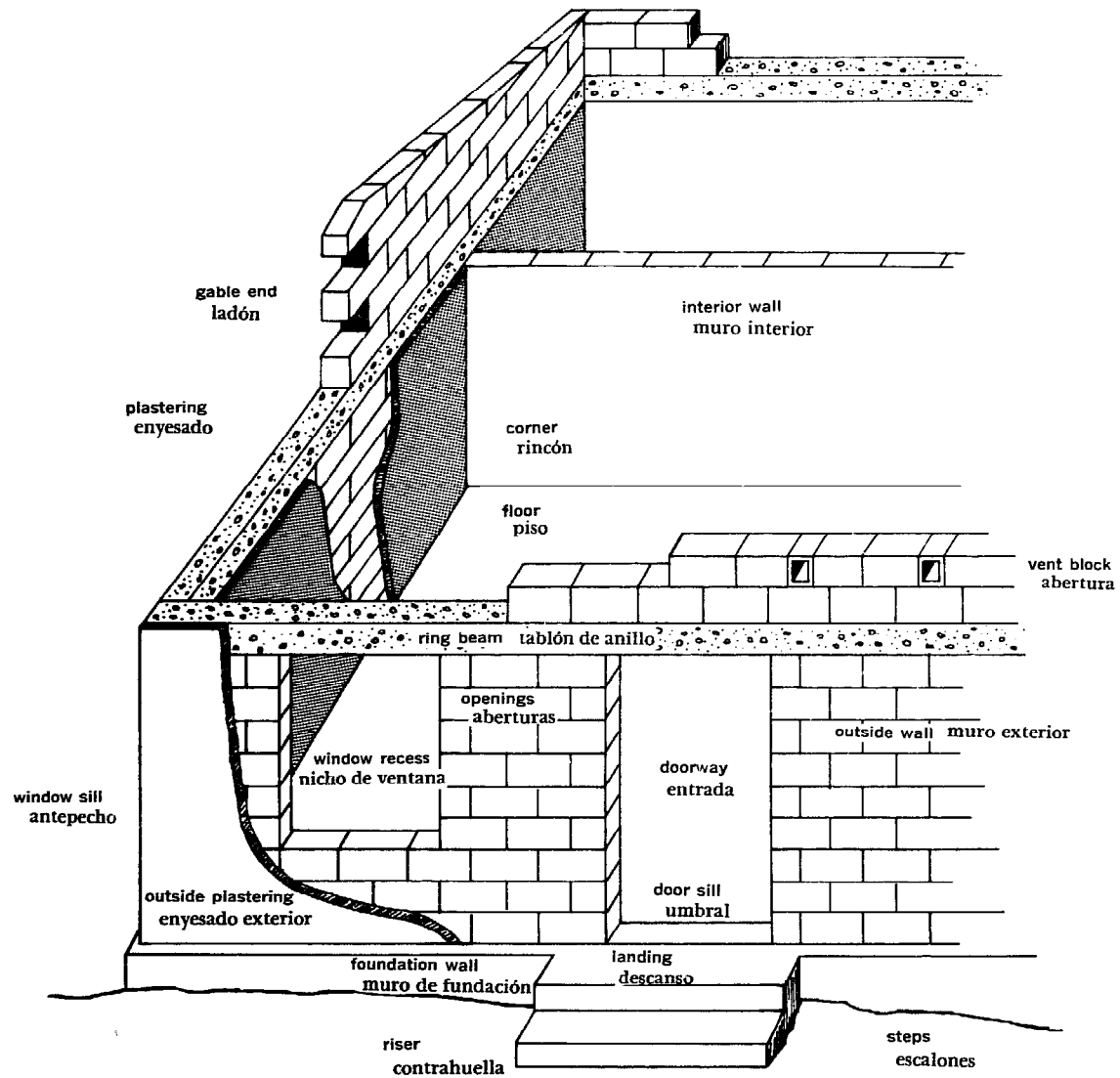

Brick or Cement Block Walls
Muros de Ladrillo

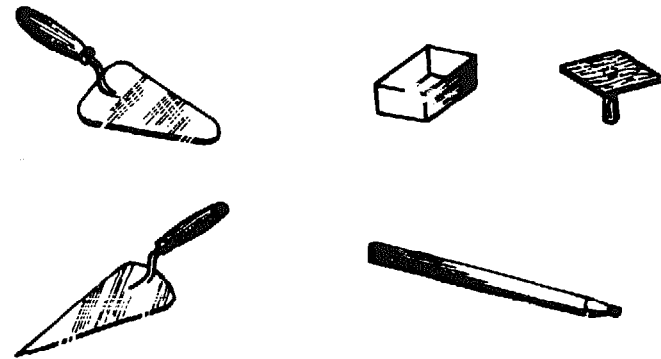
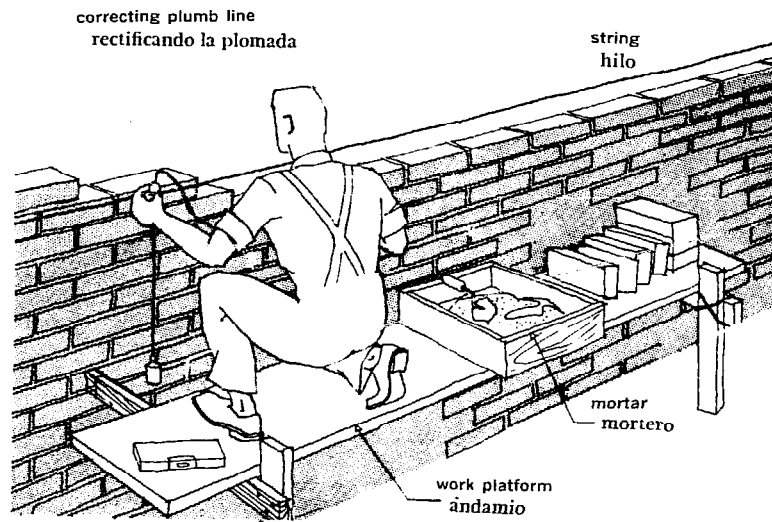

mixer and mortar
mezclero y mortero

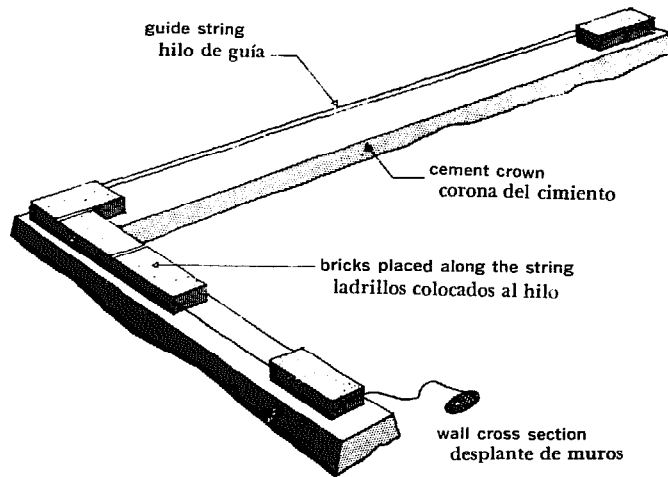
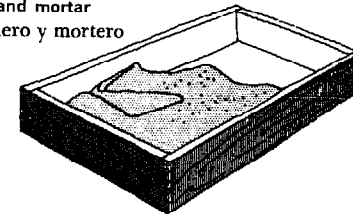

metric tape
cinta métrica

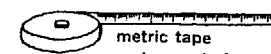

level
nivel

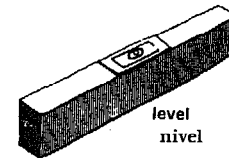

plumb bob
plomada



string
hilo



trowel
cuchara

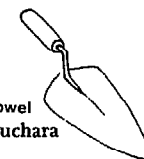

Village Brick Works
Para Hacer Ladrillos

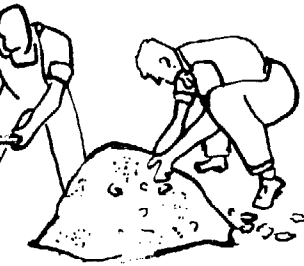

Remove large stones from clay or sieve through fine mesh.

Eliminar las piedras grandes del barro, o pasar por cedazo fino.



If not moist, add water. Cover to retard evaporation. To mold, place 4 inches of clay in level, lined pit. Tramp thoroughly, turn and tramp again.



Si el barro es seco, añada agua. Cubrir para atrasar evaporación. Para moldar, pon 4" de barro en hoyo nivelado y forrado con masonería. Mezcle completamente, voltee y mezcle de nuevo.

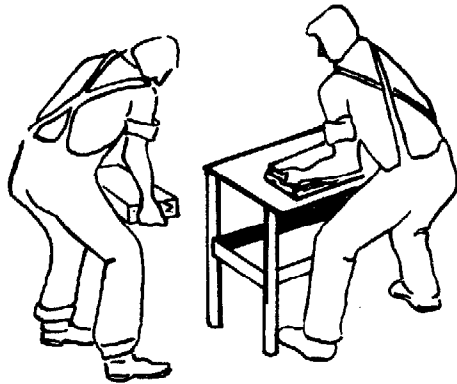

On metal covered table, form bricks in wood mold. Then take off mold and place bricks in drying area. Stack bricks a finger apart on level platform and cover to slow drying. In 3 to 7 days (depending on drying speed), stack to make room for new production. Cover again to complete drying before firing.

Sobre una mesa cubierta de metal, forme ladrillos en un molde de madera. Después saque el molde, y ponga los ladrillos hechos en otra área para secar. Amontone los ladrillos un dedo separado sobre un tablado nivelado y cubra para atrasar el secamiento. Entre 3 a 7 días (dependiendo de la rapidez del secamiento) amontone los ladrillos para dejar espacio para nueva producción. Cubre otra vez para completar el secamiento antes de ponerlos al fuego.

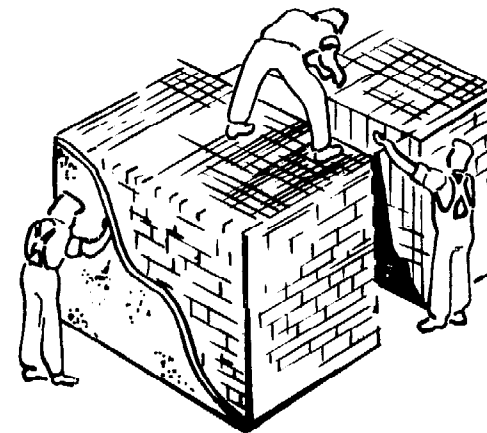
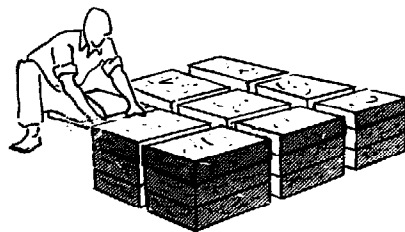
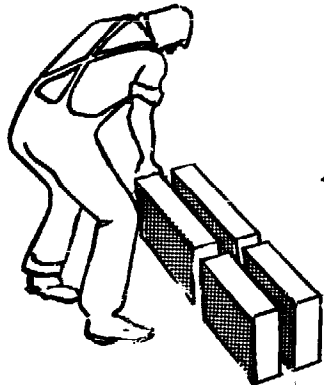

To fire, stack bricks a finger width apart, alternating headers and stretchers, providing minimum touching area and greatest stability. Stack bricks to form rough vaulted tunnels in the kiln. Cover outside of kiln with heavy layers of clay and previously fired bricks (when possible).

Para ponerlos al fuego, amontone los ladrillos un dedo separado, alternando a tizón o al hilo dejando el menos espacio posible entre ellos, y formando rudos arqueados túneles en el horno. Cubre el horno con capas espesas de barro y ladrillos previamente cocinados (cuando posible).

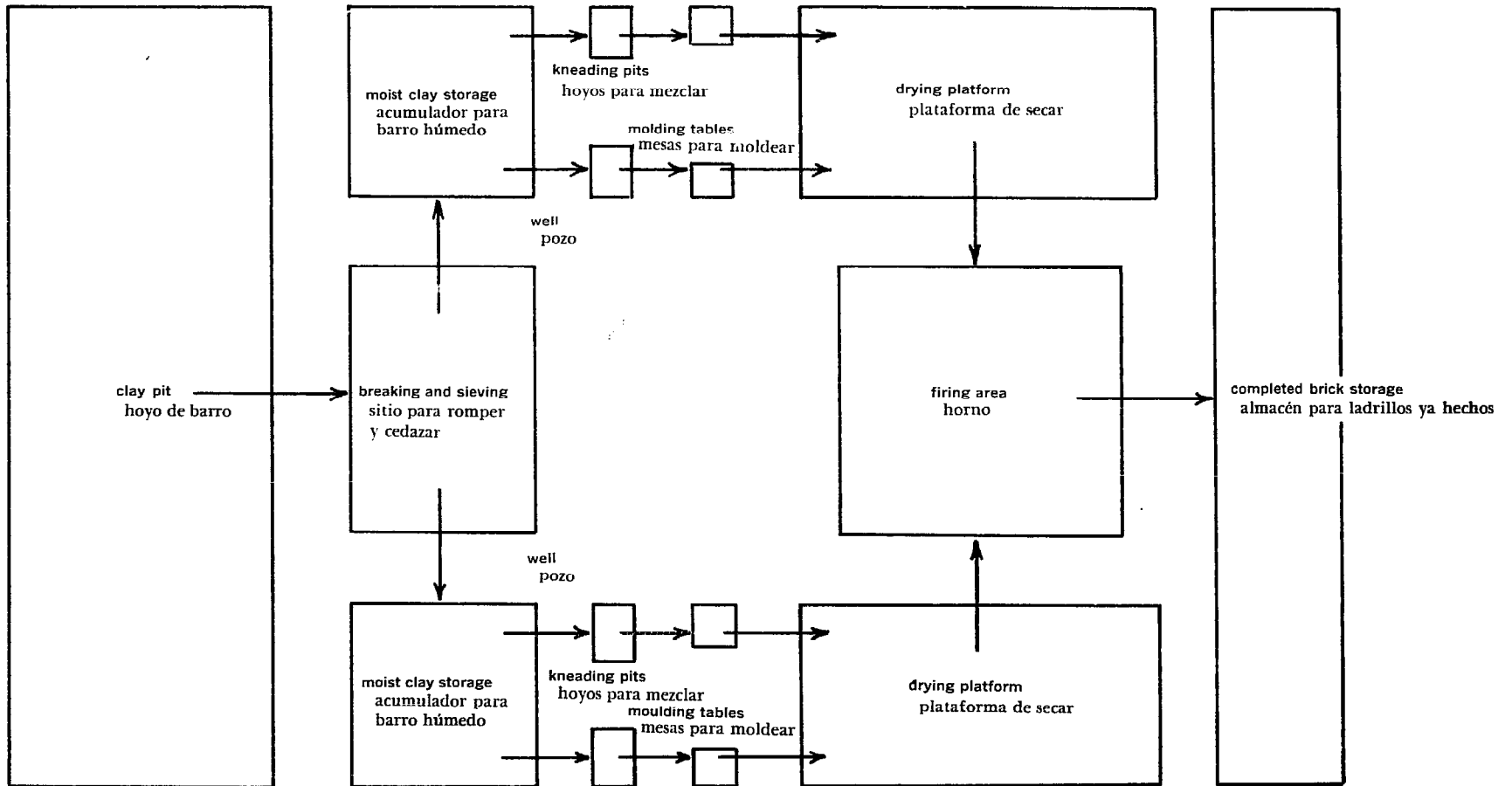

Work Sequence To Make Bricks
Lugares de Trabajo Para Hacer Ladrillos

Adobe Walls Muros de Adobe

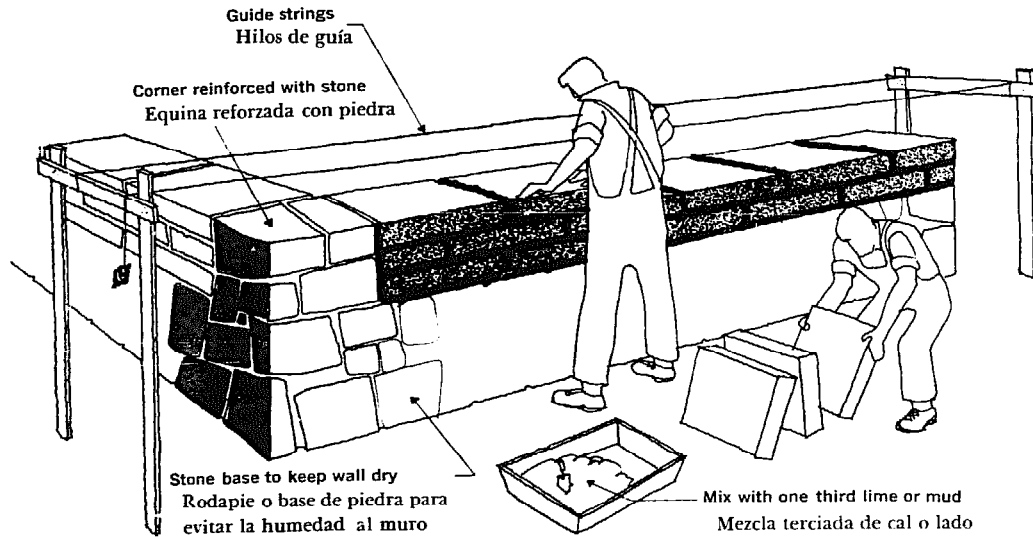

Cover layer made up of one third lime or kneaded mud
Capa de mezcla de cal terciada o lodo amasado

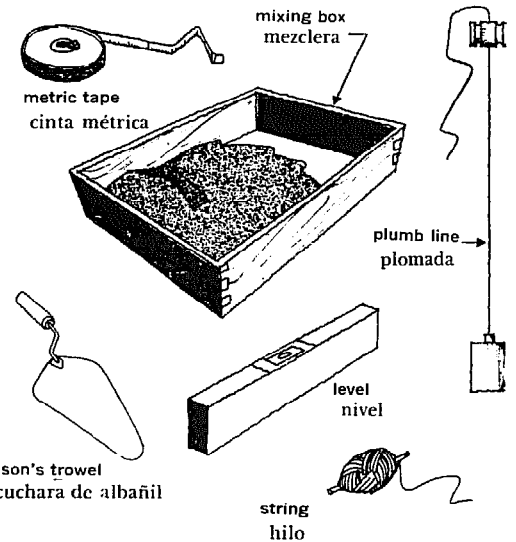
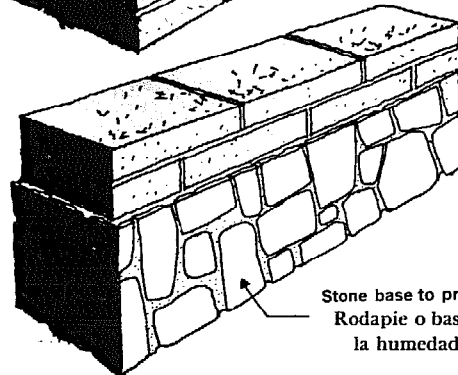
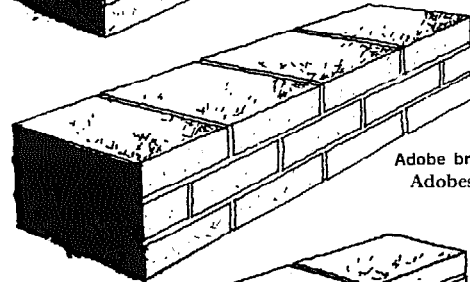
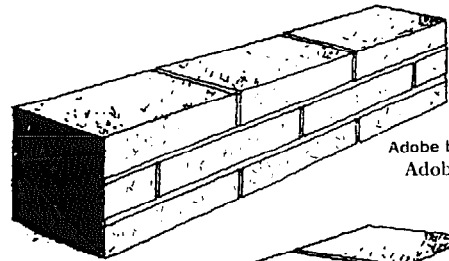
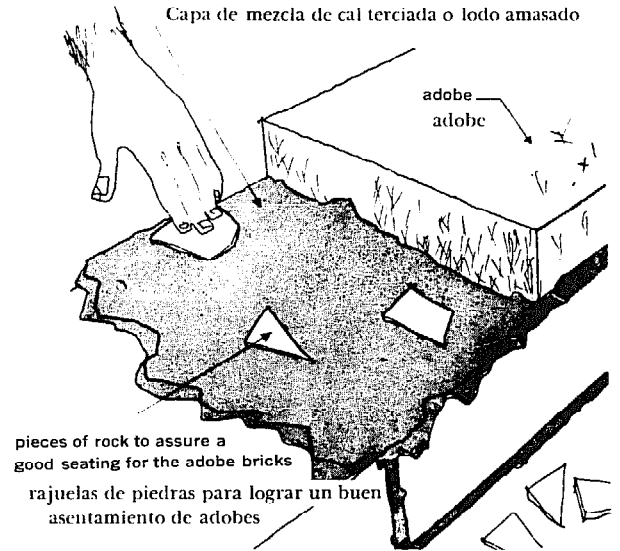

Making Adobe Bricks
Ladrillos de Adobe

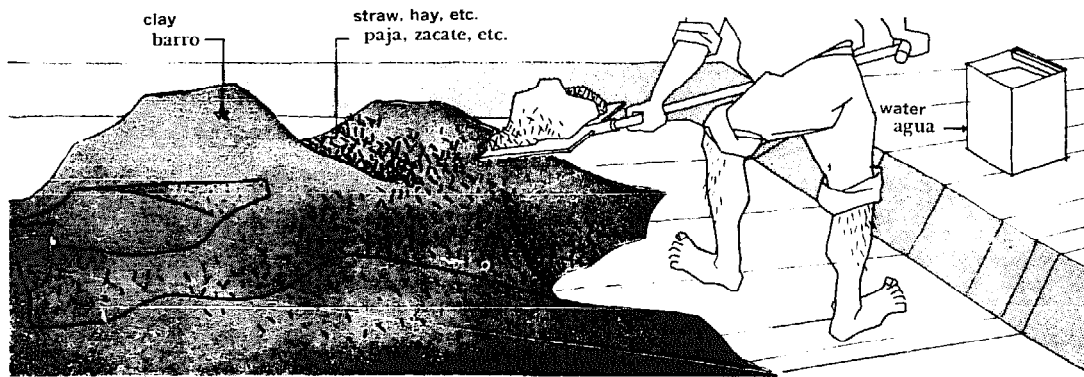

wood mold
molde de madera o "garrilla"

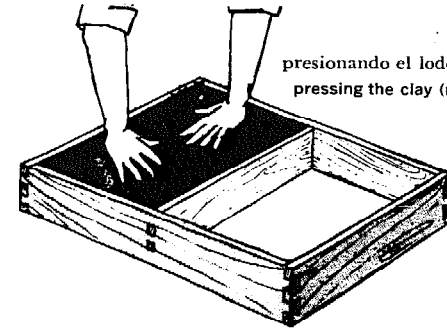
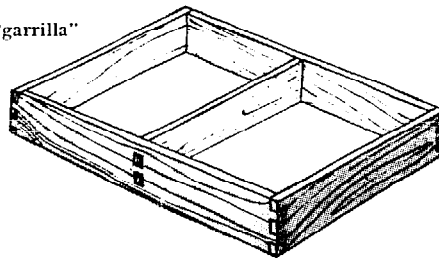

presionando el lodo
pressing the clay (mud) into the form

molding adobe bricks is done with wood forms, as shown, having the following dimensions: 40 cms long; 30 cms wide; 8 cms deep. Another good size is: 40 cms long; 20 cms wide; 8 cms deep.

el moldeo de los adobes se hace en formas de madera, como el de la figura, con las siguientes dimensiones: 40 cms largo; 30 cms ancho; 8 cms alto. Otro tamaño muy conveniente es: 40 cms largo; 20 cms ancho; 8 cms alto.

supply of recently made adobe bricks
reposito de adobes recién hechos

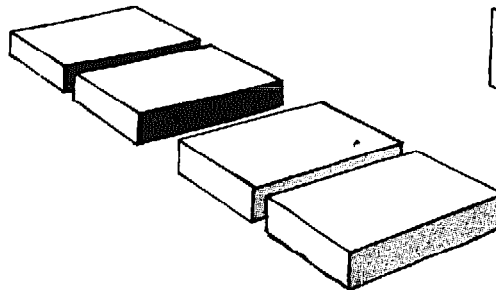

pieces in drying position
colocación de las piezas para secar

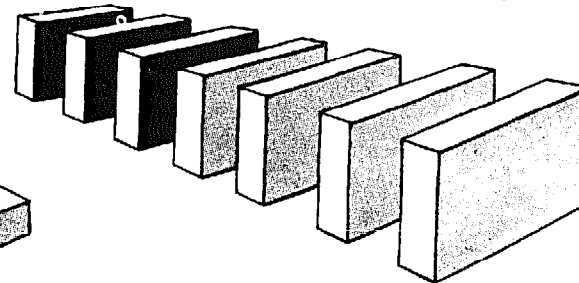

Stone Walls
Muros de Madera

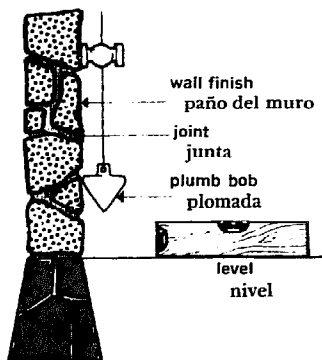
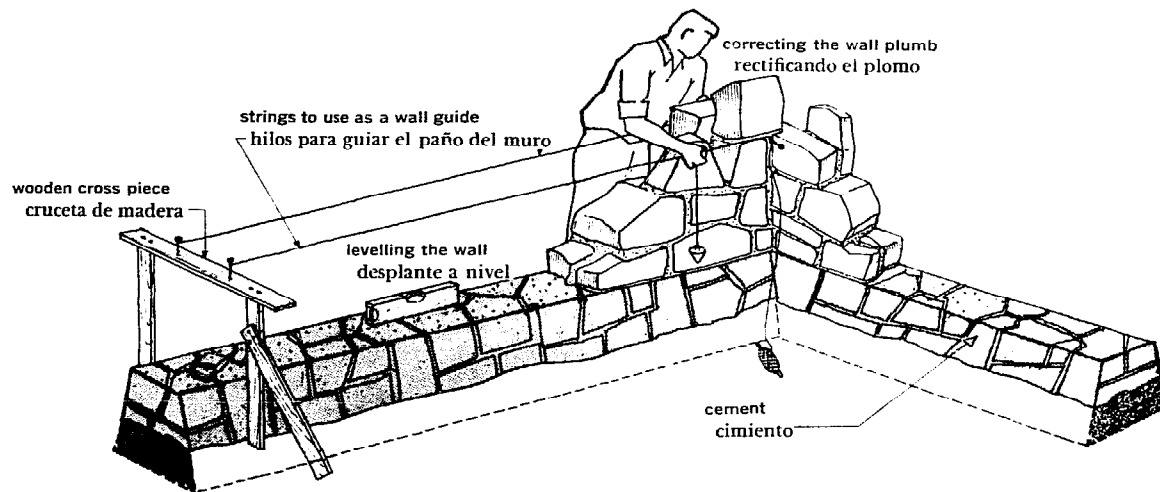

joints should alternate vertically and horizontally: correct
juntas cuatrapeadas: correcto

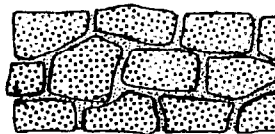

joints incorrectly laid
juntas no cuatrapeadas: incorrecto

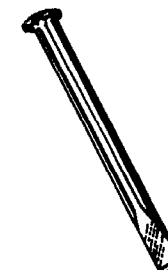
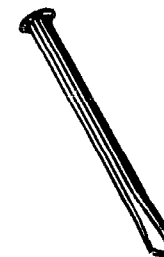
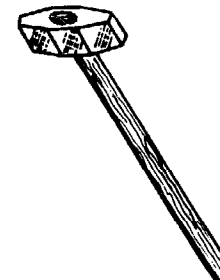
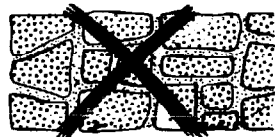

Using Plaster to Finish the Walls
Aplanado de Yeso

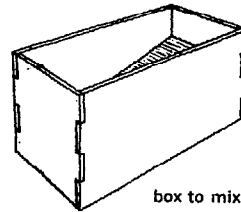
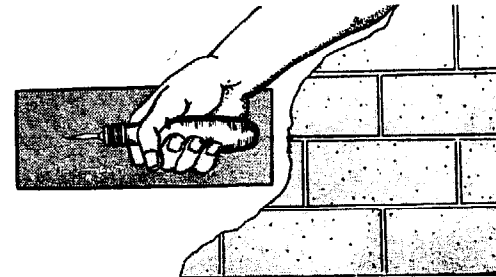
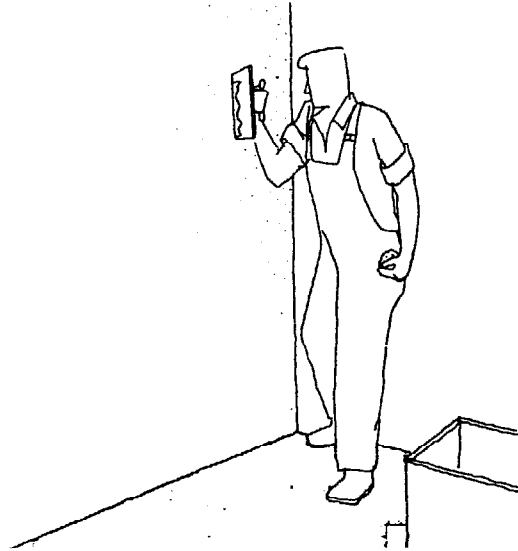
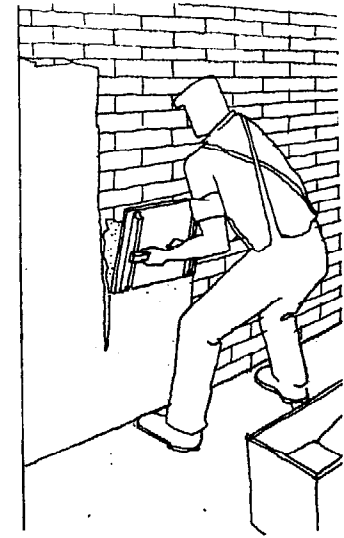
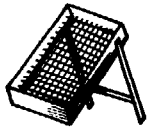
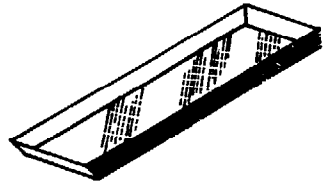

box to mix plaster
yesera o artesa

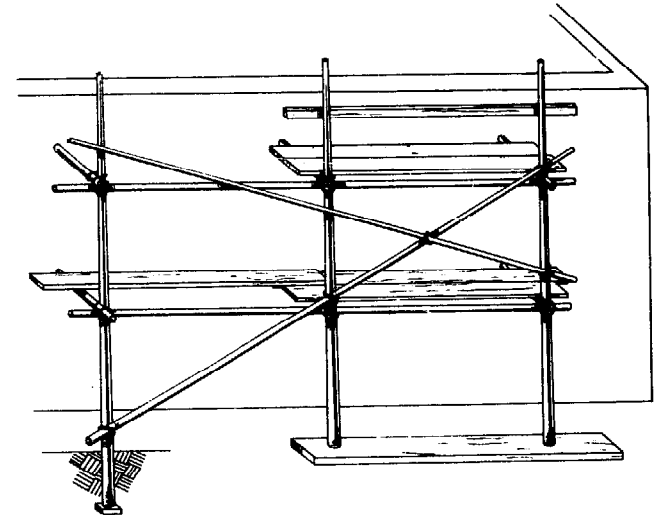

Proportions:
Proporción:

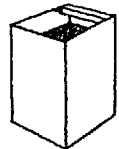

30 liters water
30 lts. agua



40 kgs. plaster
40 kgs. yeso



2 kgs. cement
2 kgs. cemento

Doors
Puertas

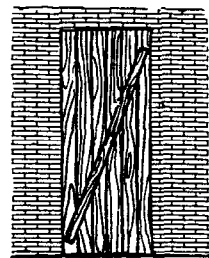
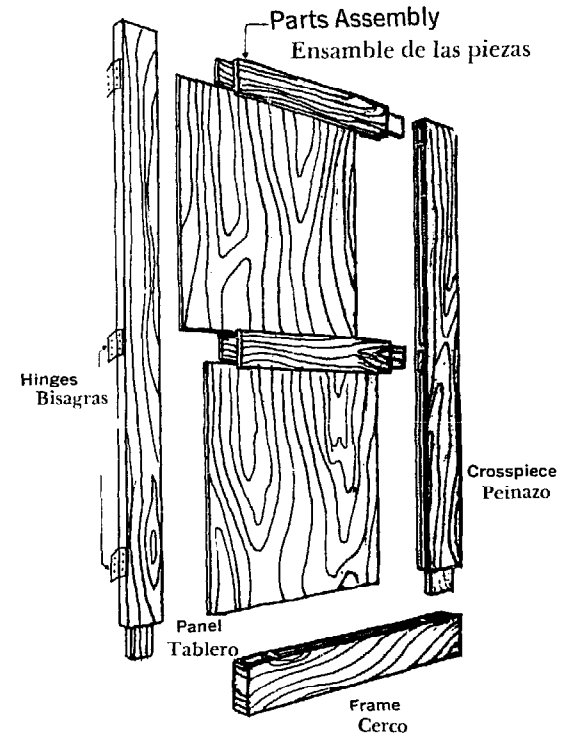
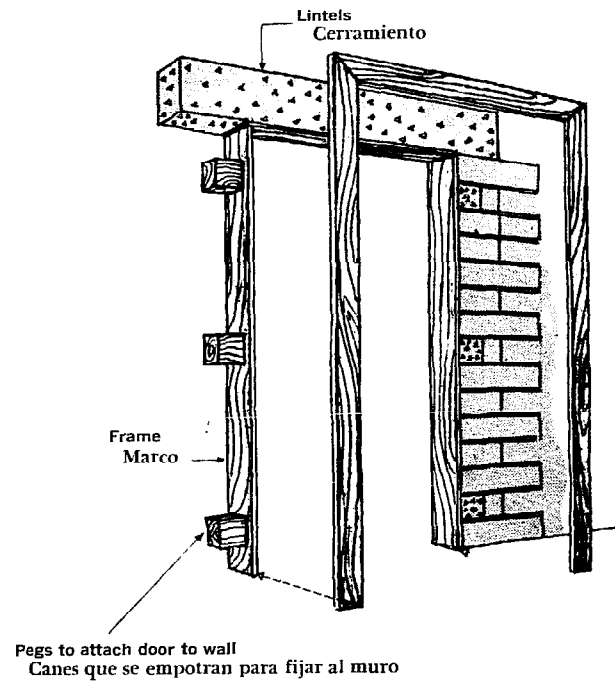

Plank Door
Puerta de Tablones

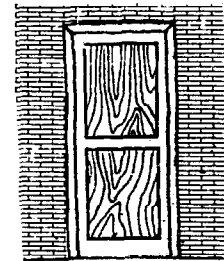

Panel door
Puerta entablada

Thresholds and Window Sills
Sardineles y Repisones

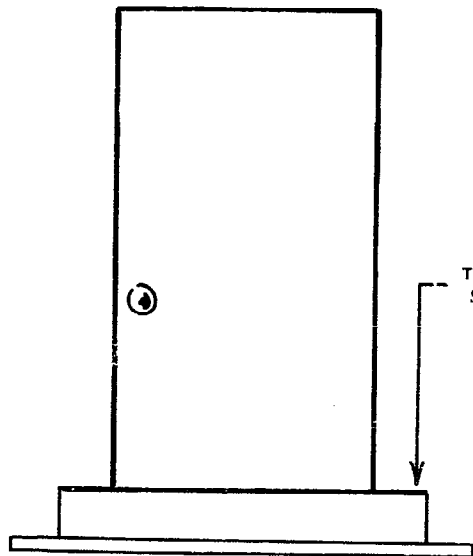
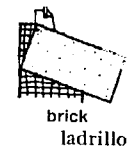
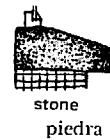
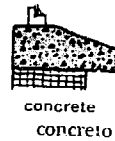
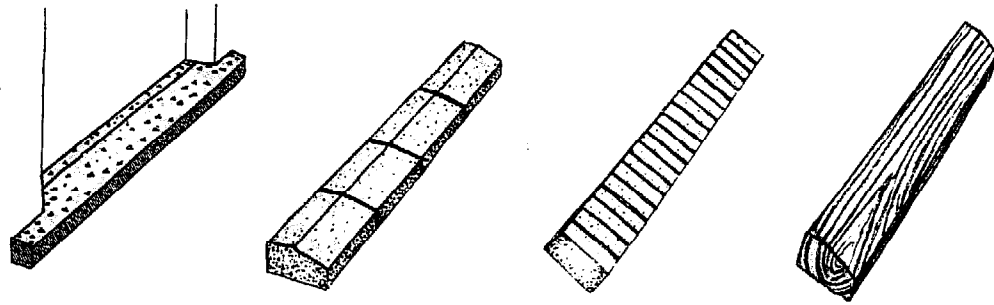
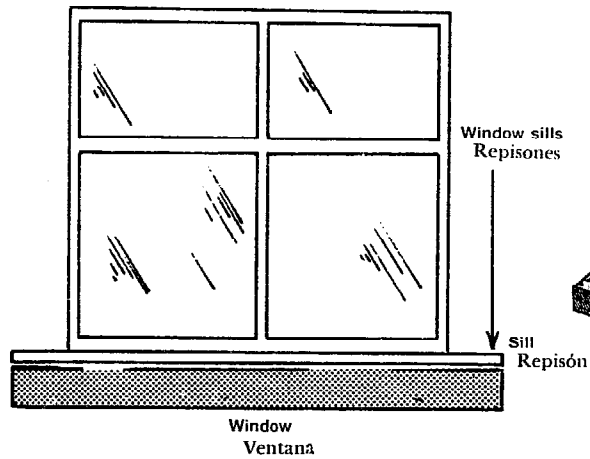

Thresholds
Sardineles

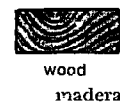
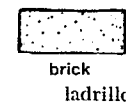
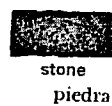
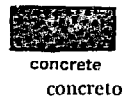
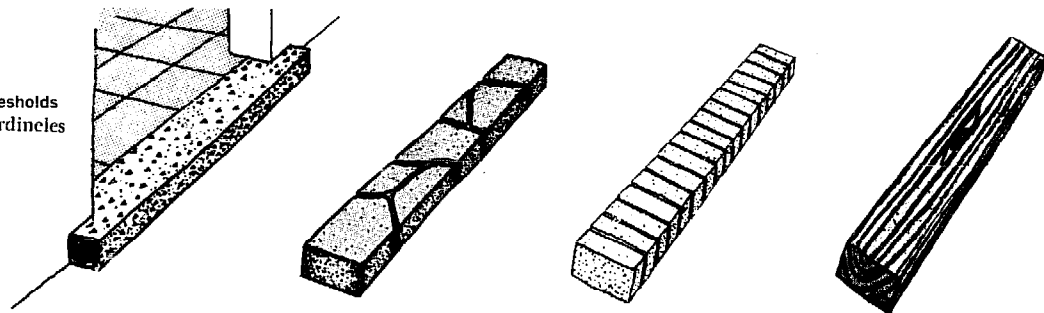

Windows and Doors

Ventanas y Puertas

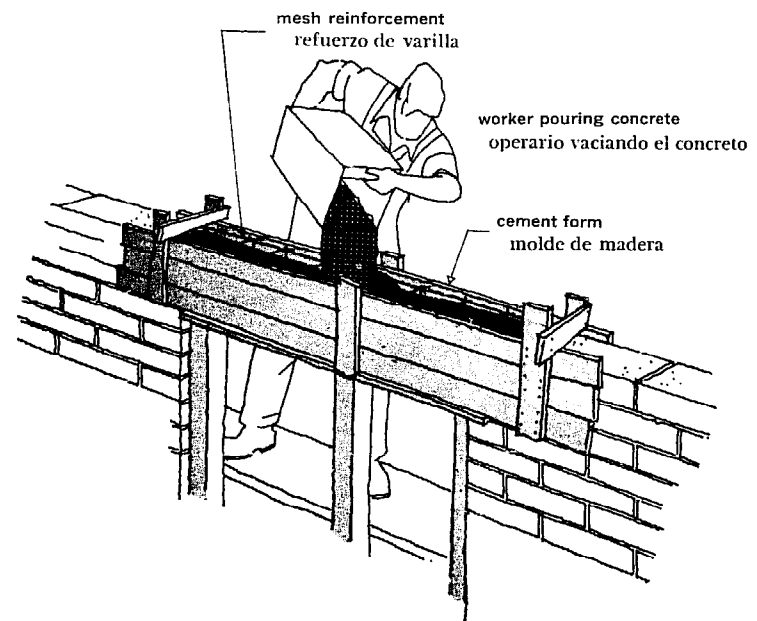
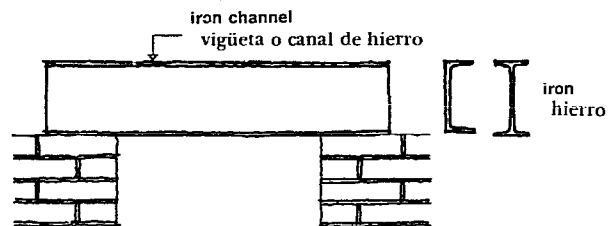
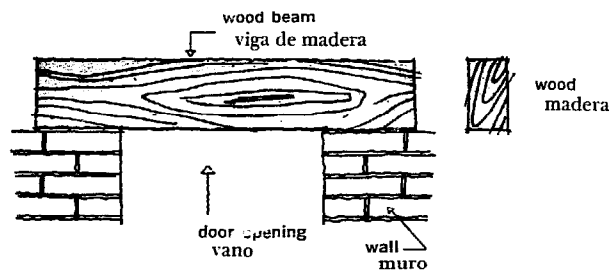
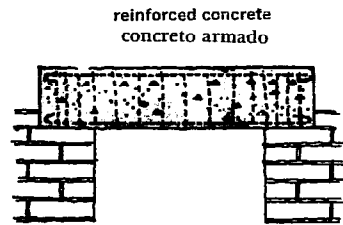

The Floors Los Pisos

Concrete
Cimiento

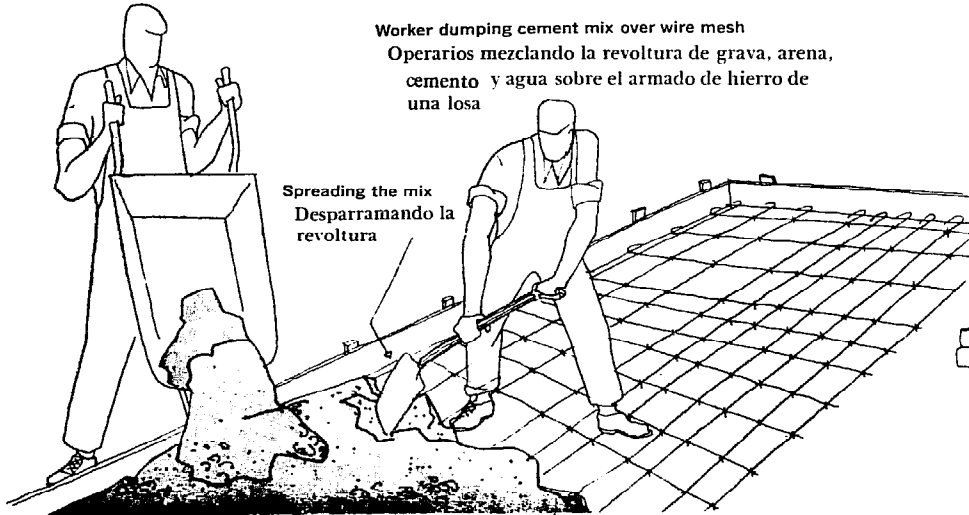

Worker dumping cement mix over wire mesh
Operarios mezclando la revoltura de grava, arena, cemento y agua sobre el armado de hierro de una losa

Spreading the mix
Desparramando la revoltura

Mixing Concrete Mezclando el cimiento

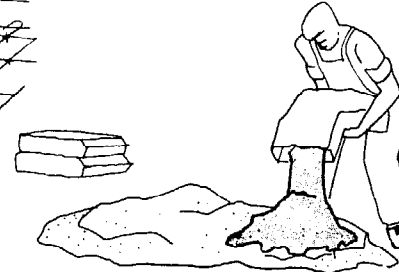

Worker dumping cement to make mix
Operario depositando el cemento sobre la arena para mezclar



Worker mixing cement and sand
Operario mezclando el cemento y arena

simple concrete floor over tamped earth
piso de cemento sobre suelo apisonado

worker tamping ground
operario apisonando

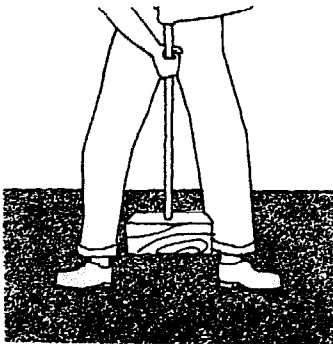

establishing floor level
by placing markers
colocación de "maestras"

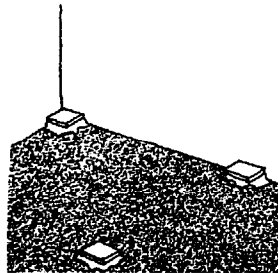

putting on coating
vaciado el firme



smoothing off floor
puliendo el acabado

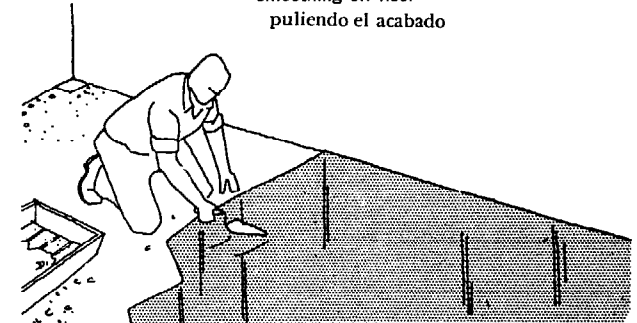

Stone Floors Pisos de Piedra Laja

Worker tamping ground for cement layer
Operario apisonando el suelo para tender el firme de cemento

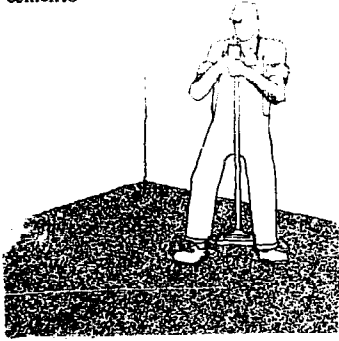

Worker placing markers
Operario colocando las muestras que servirán de guía para colocar las piezas del piso terminado

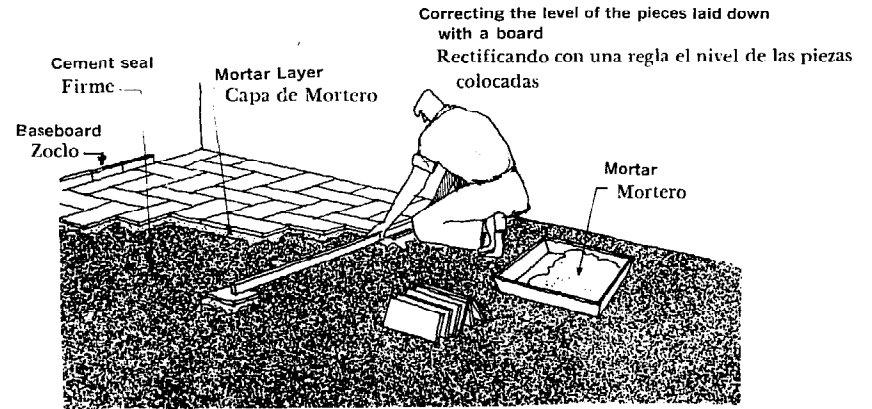
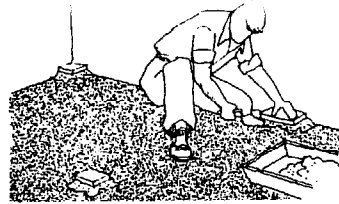

Flagstone Floor Pisos de Piedra

Tamping
Apisonando

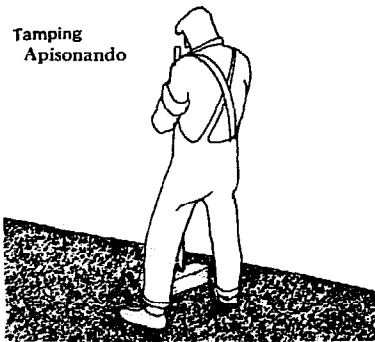

Correcting the level of the finished floor
Rectificando el nivel de piso acabado



Wood Floor
Pisos de Madera

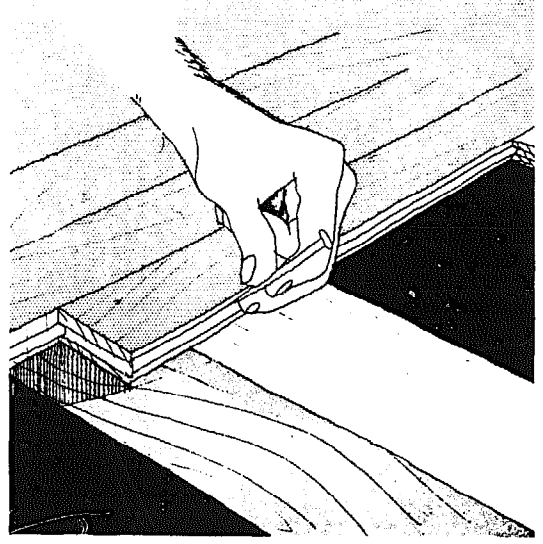
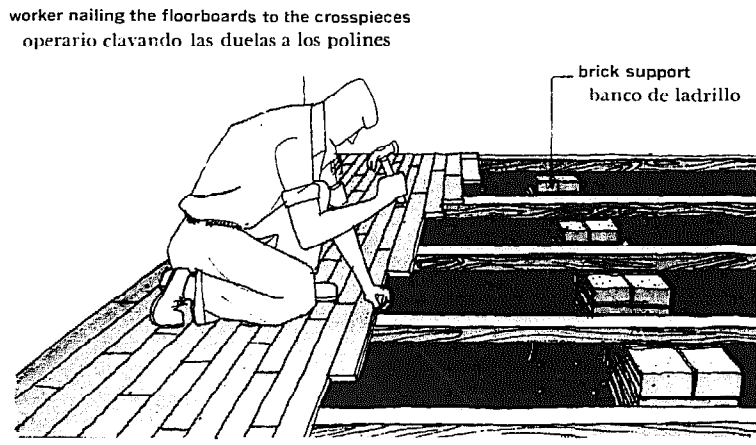
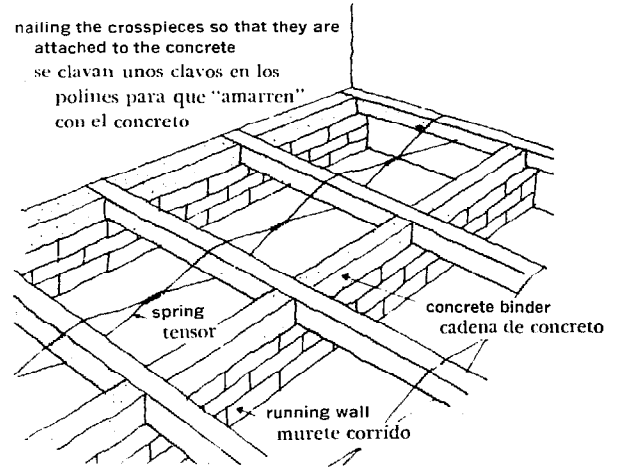
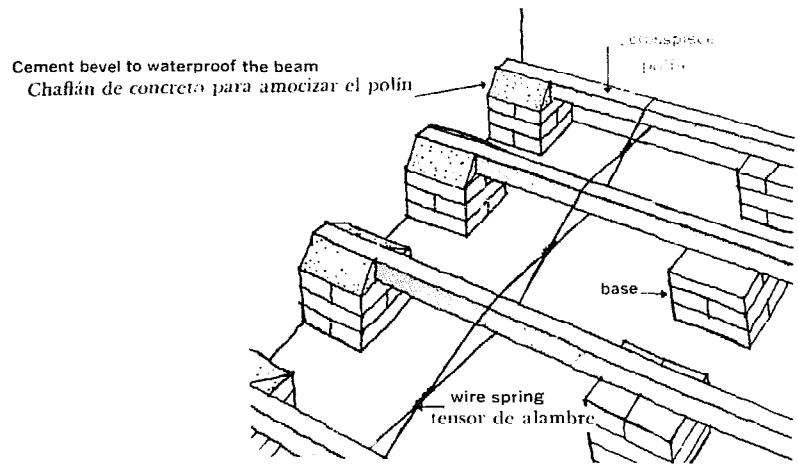

The Roof

El Techo

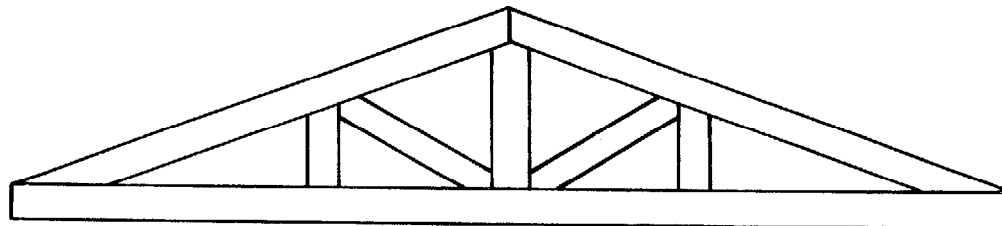
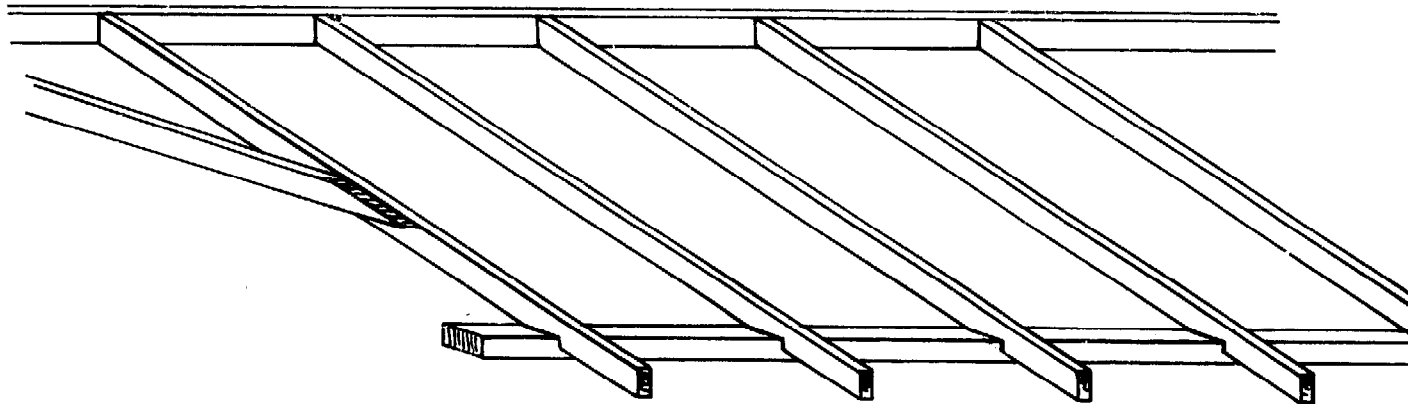
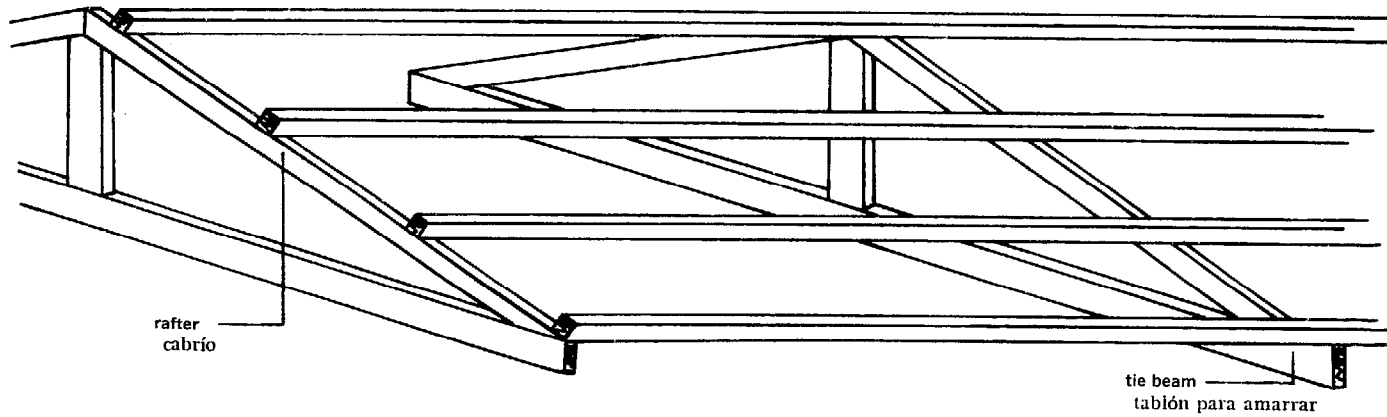

Clay Tile Roof
Techo con Tejas de Barro

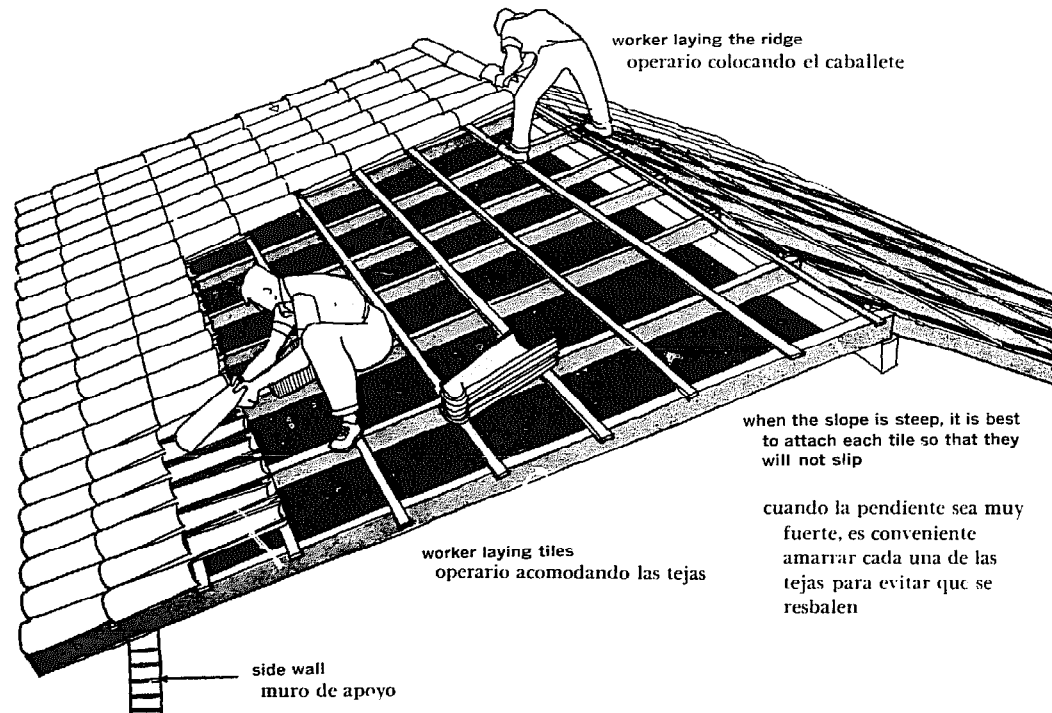
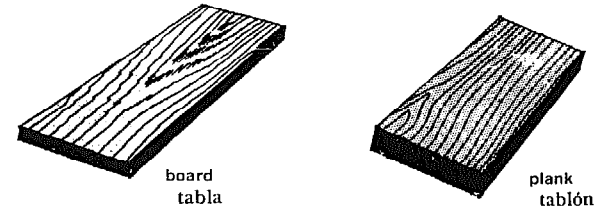
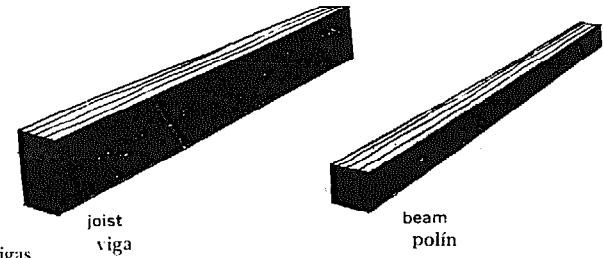
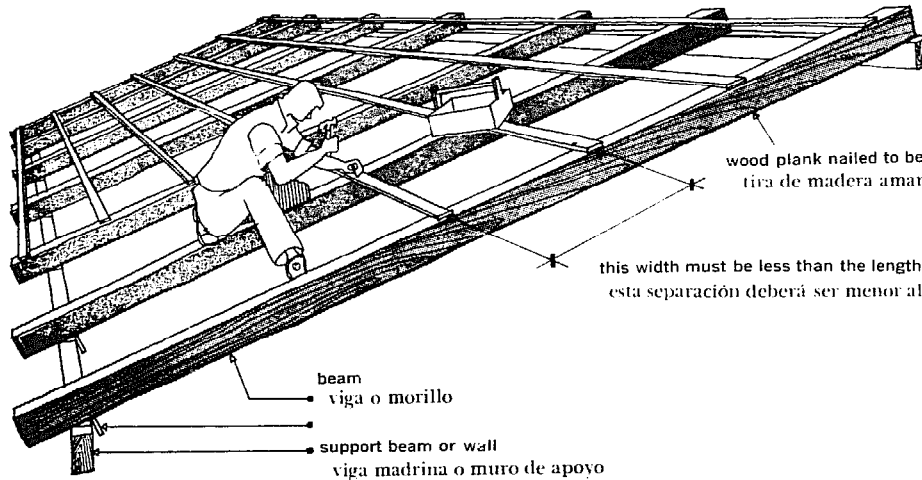

worker laying the ridge
operario colocando el caballete

worker laying tiles
operario acomodando las tejas

side wall
muro de apoyo

when the slope is steep, it is best to attach each tile so that they will not slip

cuando la pendiente sea muy fuerte, es conveniente amarrar cada una de las tejas para evitar que se resbalen

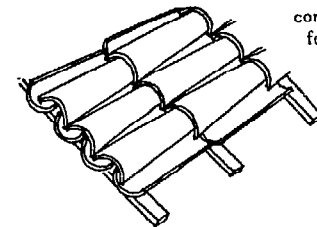

correct method of laying tiles
forma correcta de colocar las tejas



gutter tile
canal

Aluminum Roof
Techo de Aluminio

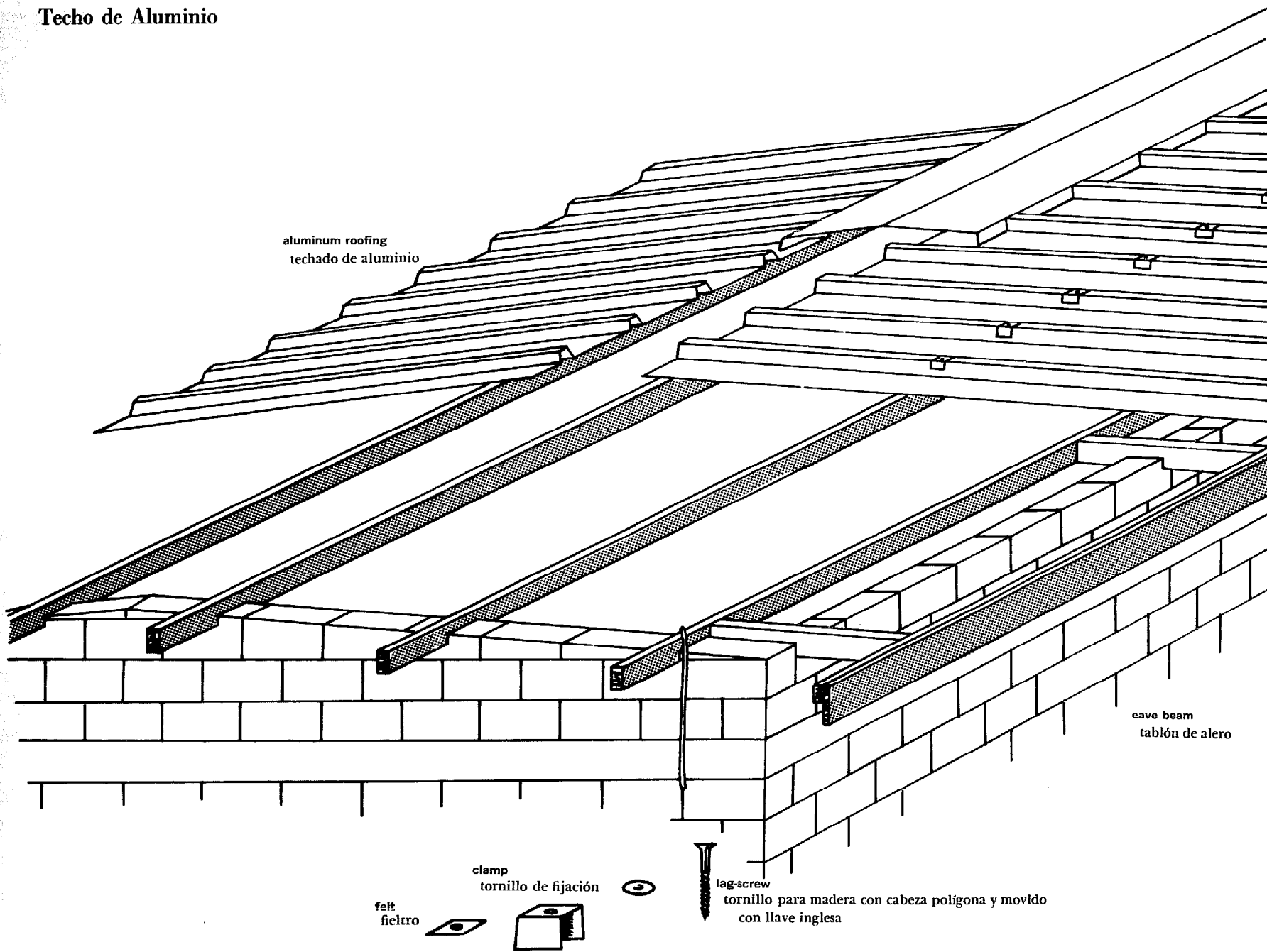

Asbestos Roof

Techo de Asbestos

Asbestos-cement sheets are made industrially by a method which mixes these two materials, and produces sheets of different thicknesses and sizes. These sheets are used for house roofs or industrial and store roofs. They are water and fireproof, good as insulation against both heat and cold, and their resistance to rot and deformity make them very useful in building.

Las láminas de asbestos-cemento están hechas por un procedimiento industrial que mezcla estos dos materiales produciendo placas duras de diferentes espesores y dimensiones. Estas láminas se usan indistintamente para techar casas y locales industriales o para bodegas. Sus cualidades impermeables, incombustibles, aislantes de calor y el frío del medio ambiente, su indeformibilidad, su imputrescibilidad y su resistencia las hacen ser de gran utilidad para la construcción.

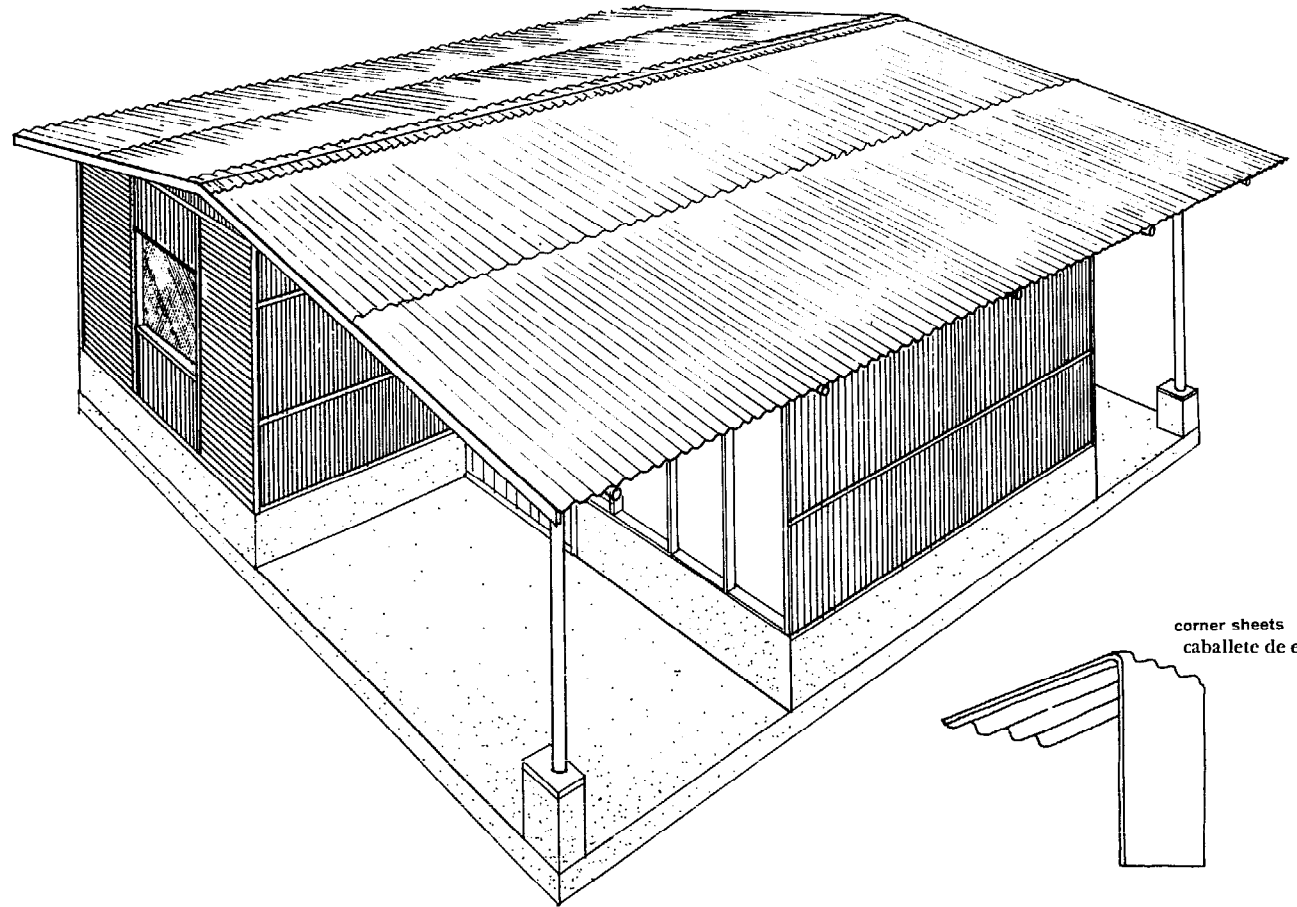

corner sheets
caballete de esquina

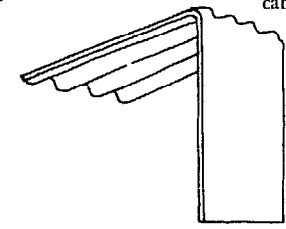

shapes and sizes needed for assembly
formas y tamaños necesitados para construir

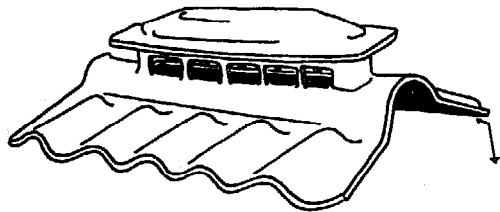

ridge sheets
caballete de centro

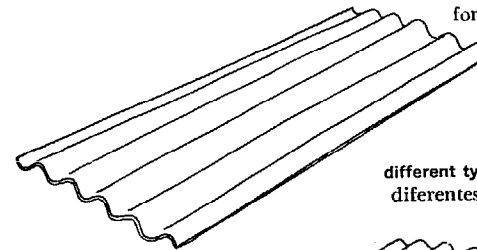
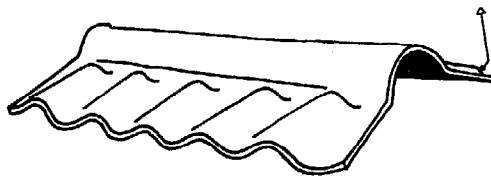

different types of sheets
diferentes clases de láminas

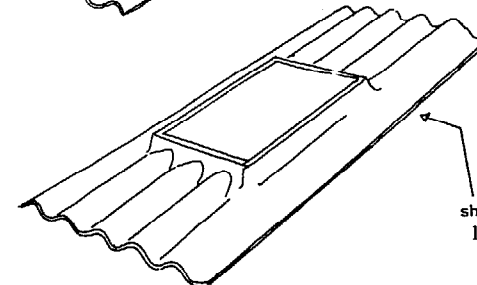

sheet with skylight
lámina con tragaluz

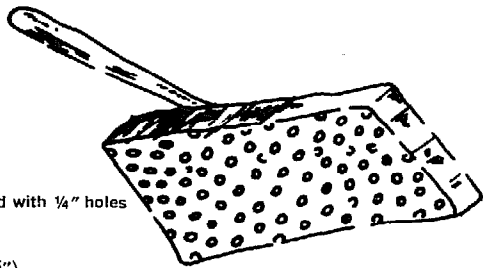

thatching board 12" x 16" drilled with 1/4" holes
completed section

tabla para empajar (12"x16")
perforada con hoyos de 1/4"
de diámetro

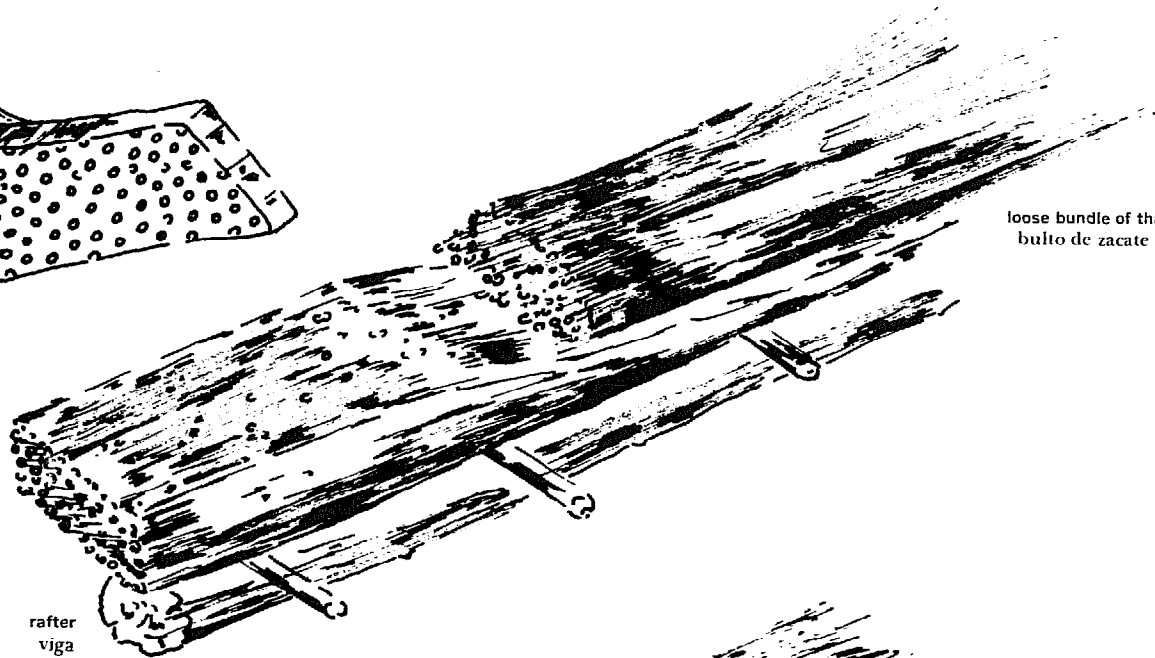

loose bundle of thatch grass
bulto de zacate

rafter
viga

starting from the top of bundle,
push thatching board against
grass ends repeatedly until
surface is even and level.

comenzando a la cima del
bulto, empujan la tabla para
empajar contra las puntas
de la paja repetidamente
hasta que la superficie esté
uniforme y nivelada

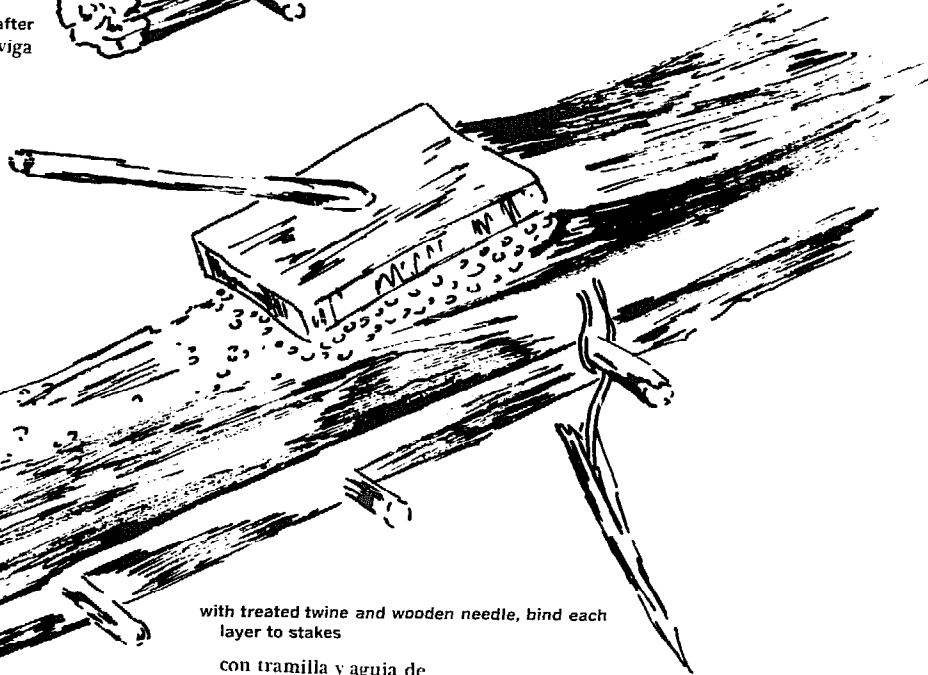

completed section
sección acabada

with treated twine and wooden needle, bind each
layer to stakes

con tramilla y aguja de
madera, se debe atar cada
capa a las estacas

Thatched Roof
Techo de Zacate

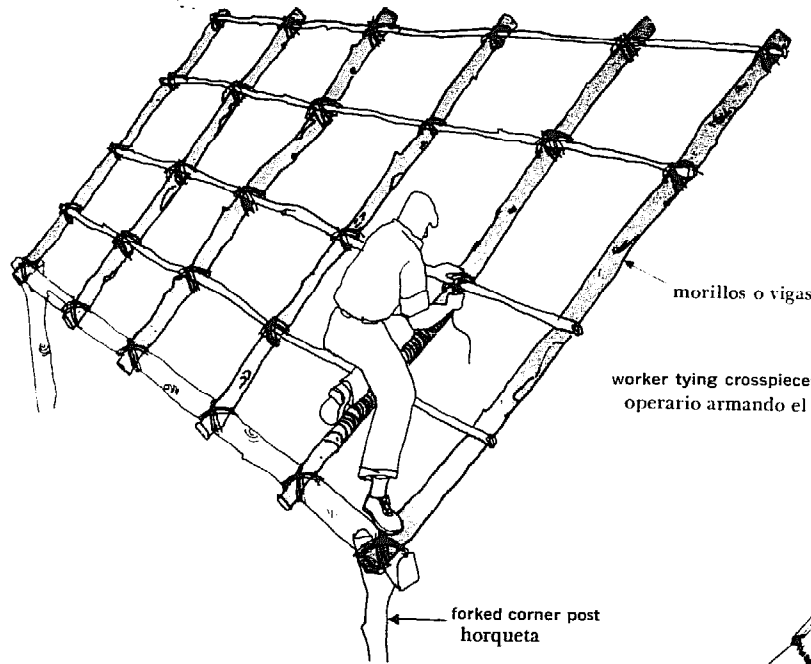

morillos o vigas
worker tying crosspieces to beams
operario armando el entramado

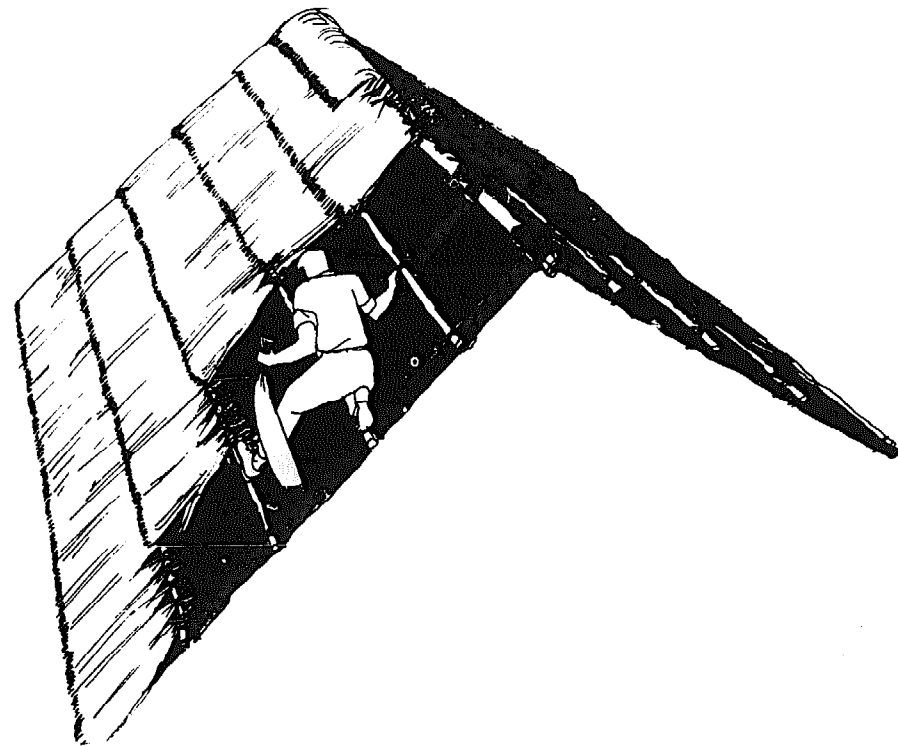

Water Supply Systems

Agua Para Usos Domesticos

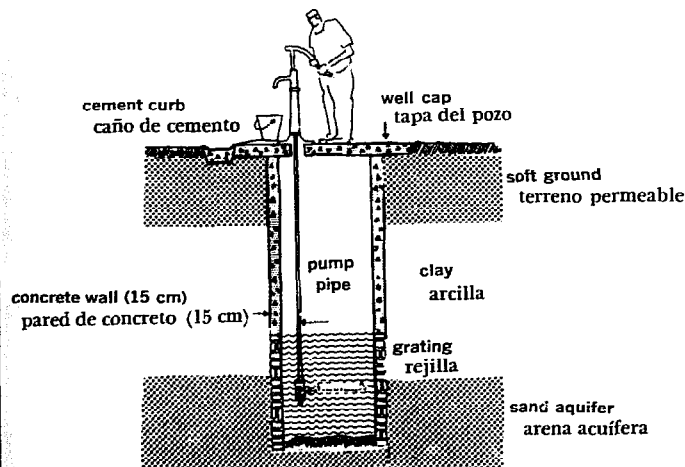
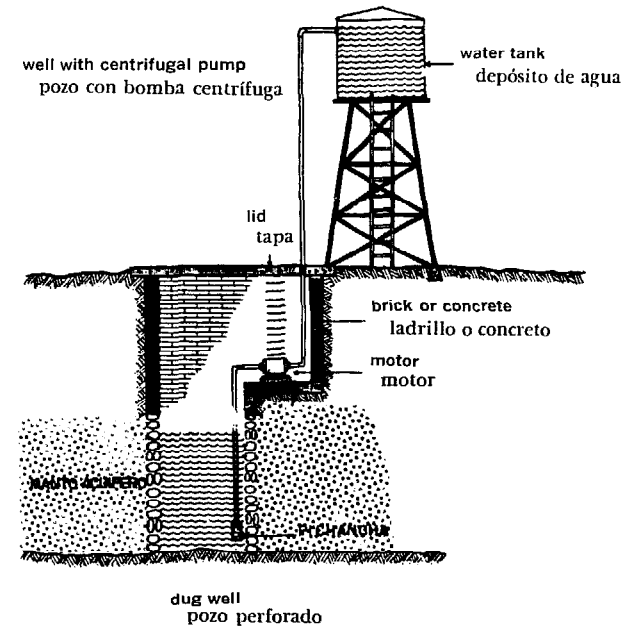
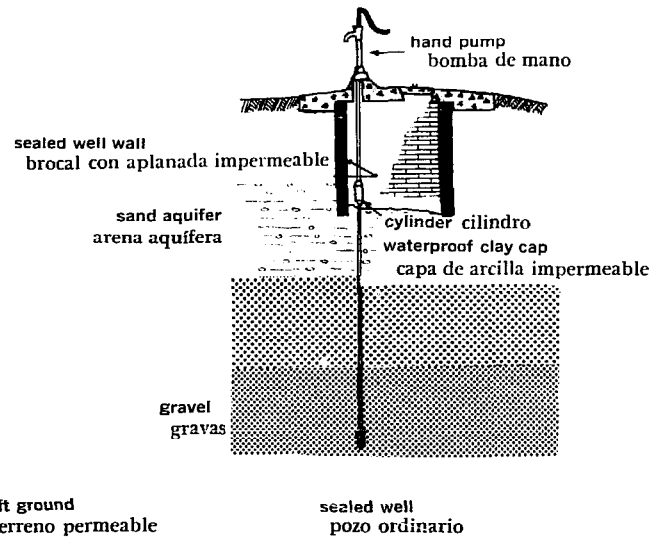
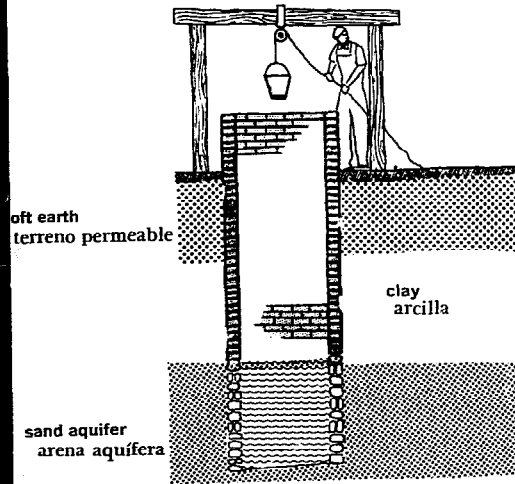
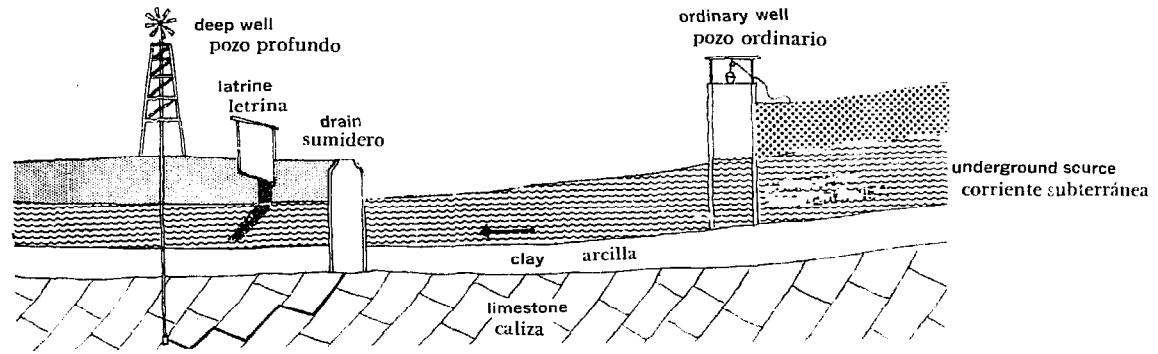

House Plumbing System Instalación y Drenaje

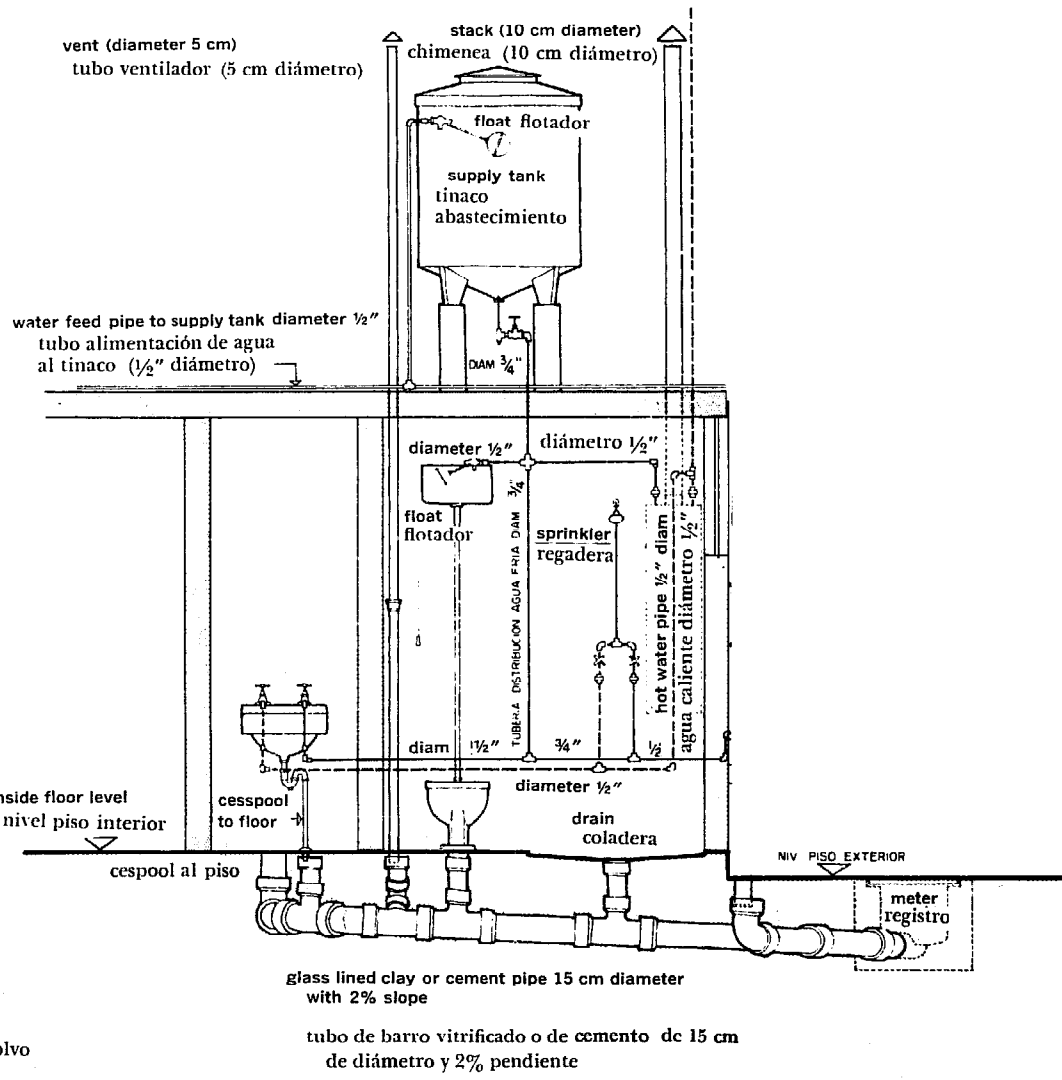

Water Purification Methods Filtros Domésticos

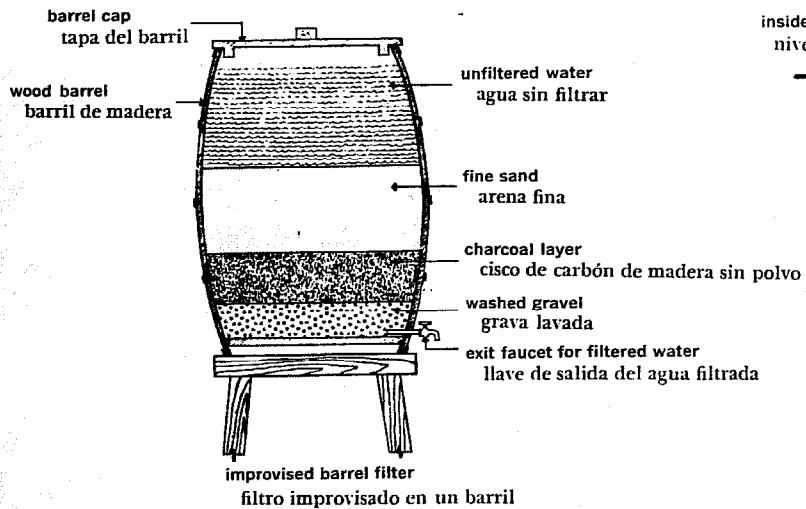

Plumbing
Tubería

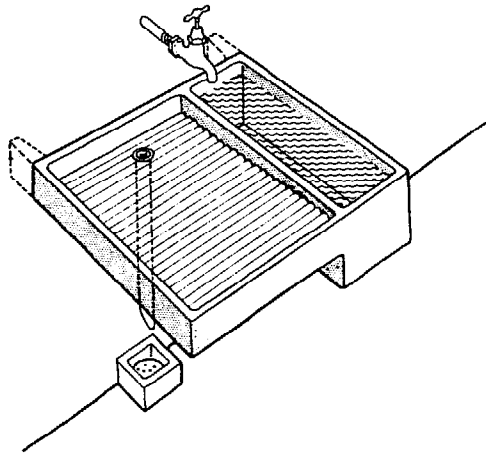

prefabricated concrete sink
lavadero prefabricado de cemento

Kitchen
Cocina

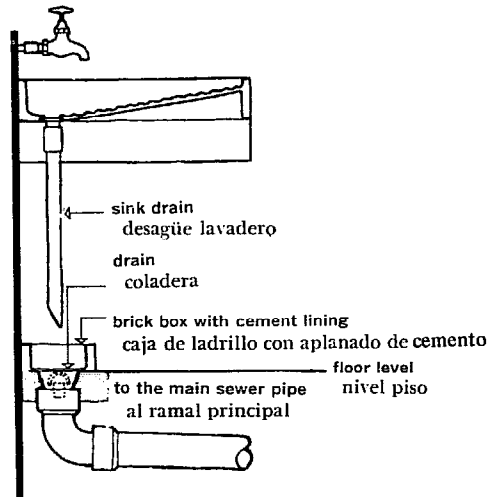

sink drain
desagüe lavadero
drain
coladera
brick box with cement lining
caja de ladrillo con aplanado de cemento
to the main sewer pipe
al ramal principal
floor level
nivel piso



double lead trap with meter
cespool doble de plomo con registro

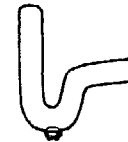

simple lead trap with meter
cespool sencillo de plomo con registro

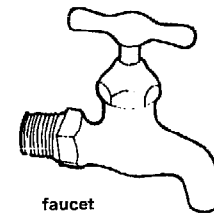

faucet
llave de nariz

Bathroom
Baño

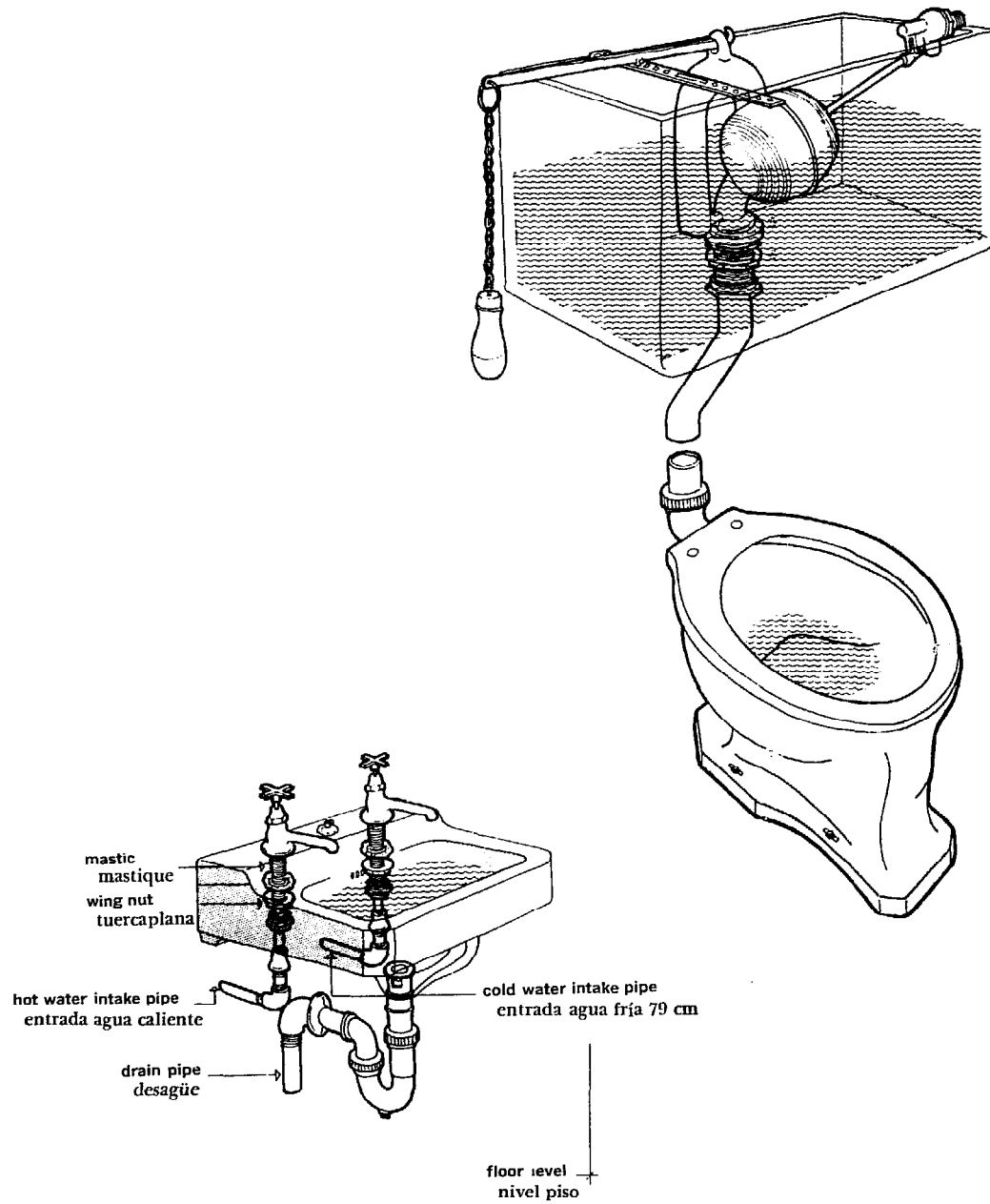

Shower
Ducha

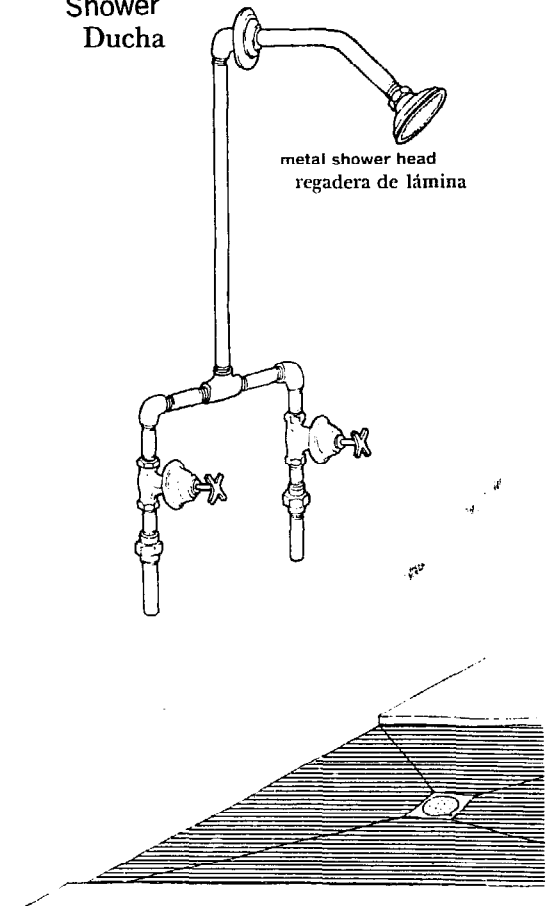

Sewerage Disposal Systems Alcantarillado-Letrinas

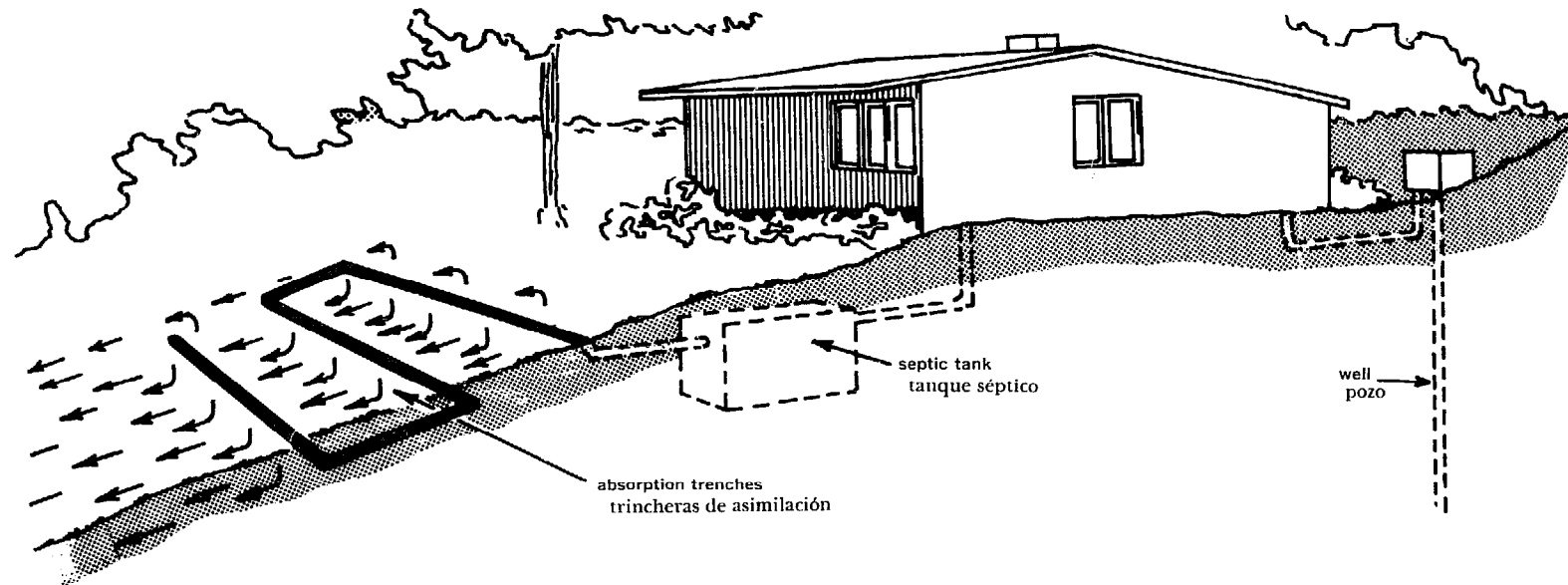

the well should be at a
higher level than the
septic tank system
to protect it from
sewage contamination

el pozo debe ser más alto que el
alcantarillado para protección
contra contaminación

Absorption Trench and Lateral
Trinchera de Asimilación y Lateral

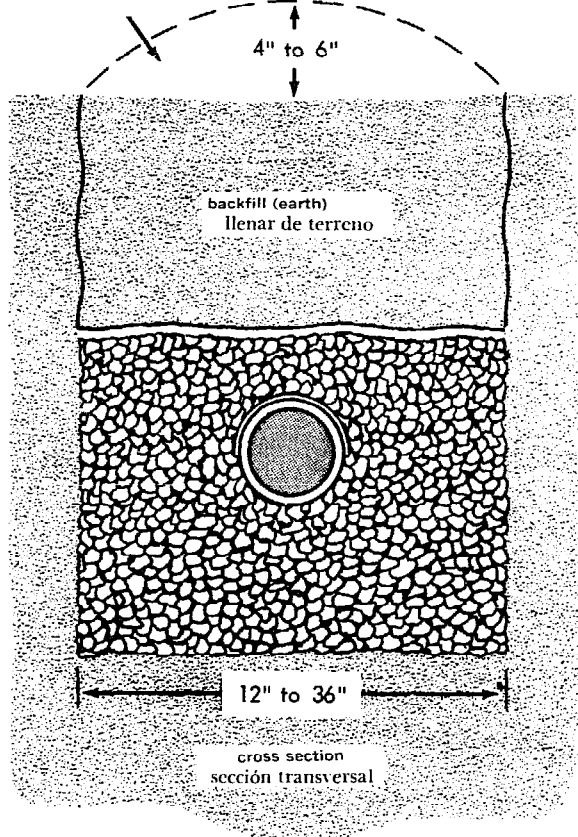

Septic Tank Sewage Disposal Systems
Sistema de Alcantarillado con Tanque Séptico

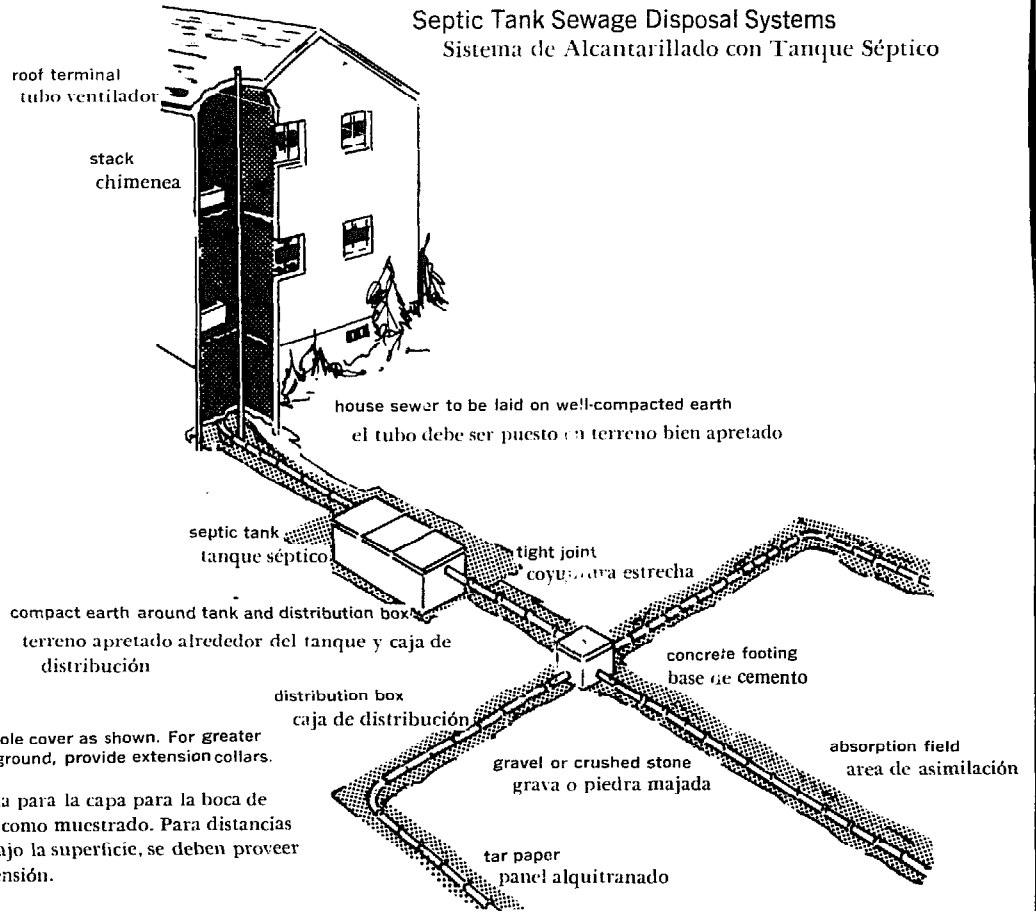

Household Septic Tank
Tanque Séptico para Uso Doméstico

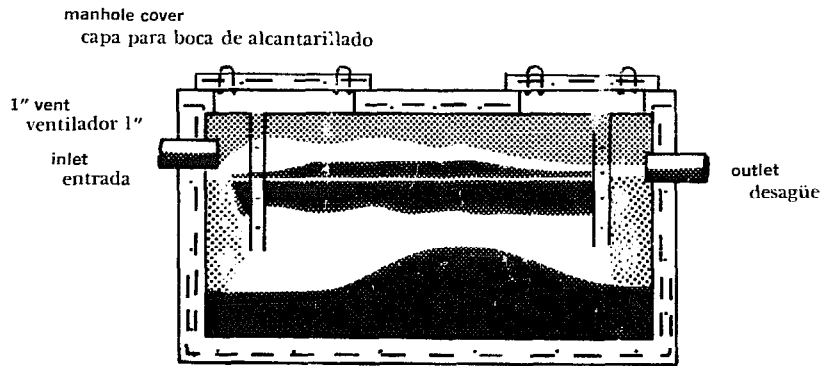

Maximum for manhole cover as shown. For greater distances below ground, provide extension collars.

Distancia máxima para la capa para la boca de alcantarillado como muestrado. Para distancias más grandes bajo la superficie, se deben proveer cuellos de extensión.

Penetration of outlet baffle generally 40% of liquid depth (for rectangular tanks)

Penetración del ventilador generalmente 40% de la hondura del líquido (tanques rectangulares)

NB: make inlet at least 1-3" above outlet

NB: la entrada debe ser 1-3" sobre el desagüe

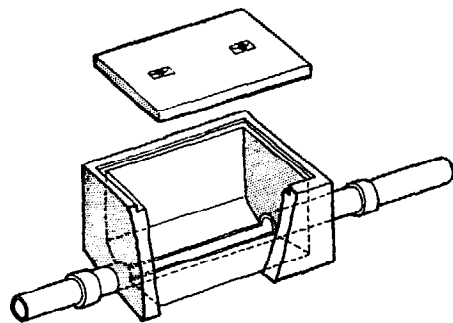

side view of junction box
corte en perspectiva de un registro

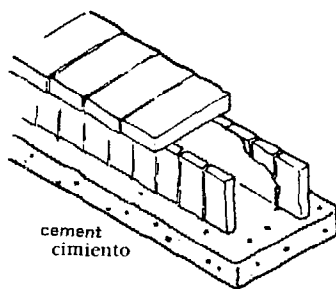

cement
cemento

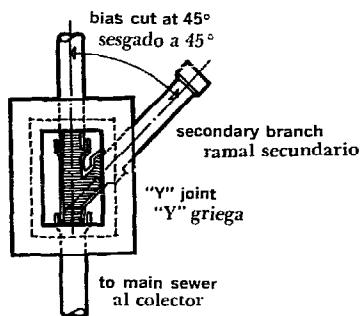
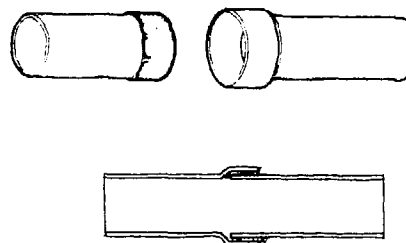

bias cut at 45°
sesgado a 45°

secondary branch
ramal secundario

"Y" joint
"Y" griega

to main sewer
al colector

principal branch entry into junction box
ramal principal de entrada al registro
menos de 45°

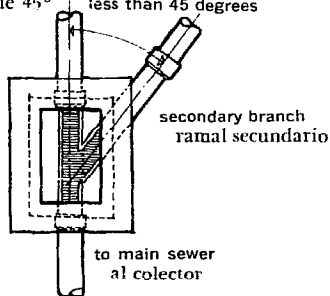

less than 45 degrees

secondary branch
ramal secundario

to main sewer
al colector

connection at less than 45 degrees
conexión a menos de 45°

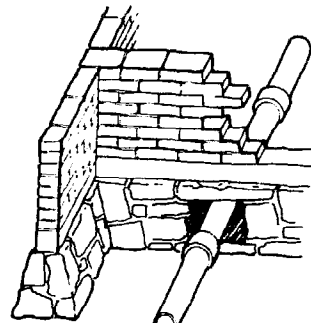

hole to protect the sewer from possible
collapse

Hueco para proteger el albañal de posibles
hundimientos

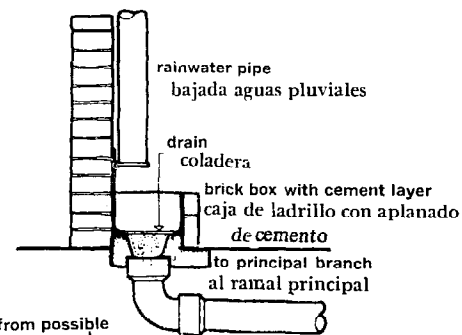

rainwater pipe
bajada aguas pluviales

drain
coladera

brick box with cement layer
caja de ladrillo con aplanado
de cemento

to principal branch
al ramal principal

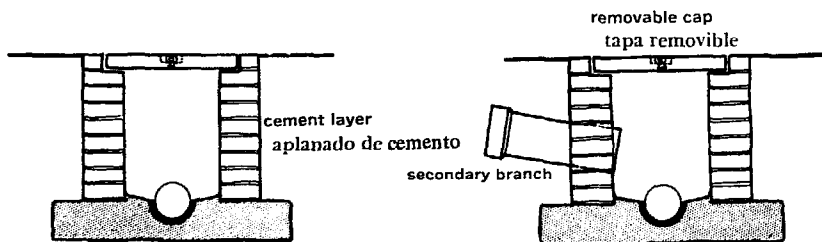

cement layer
aplanado de cemento

secondary branch

depth of medium sized junction box
fondo de registro con medio tubo

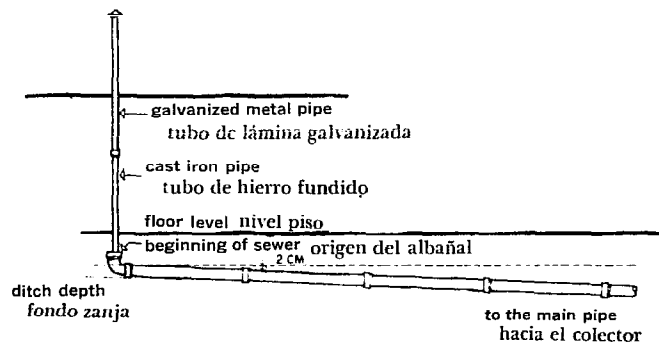

galvanized metal pipe
tubo de lámina galvanizada

cast iron pipe
tubo de hierro fundido

floor level nivel piso

beginning of sewer origen del albañal

ditch depth
fondo zanja

to the main pipe
hacia el colector

Outhouses or Latrines
Alcantarillado-Letrinas

Bucket Latrine
Letrina a Pozal

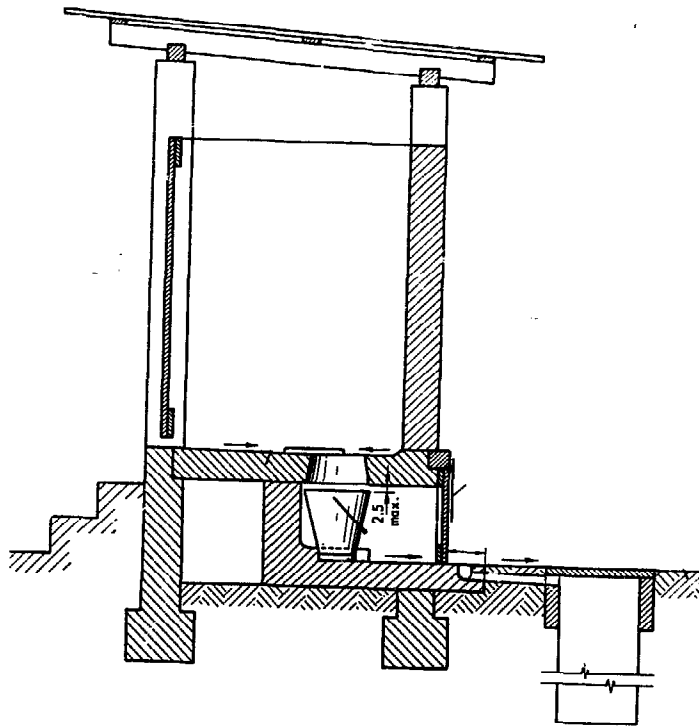

latrine of cut lumber with corrugated metal or
asbestos cement roof

letrina de tabiadas con techo de metal acanalado
o asbestos-cemento

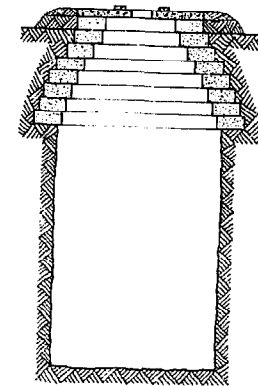
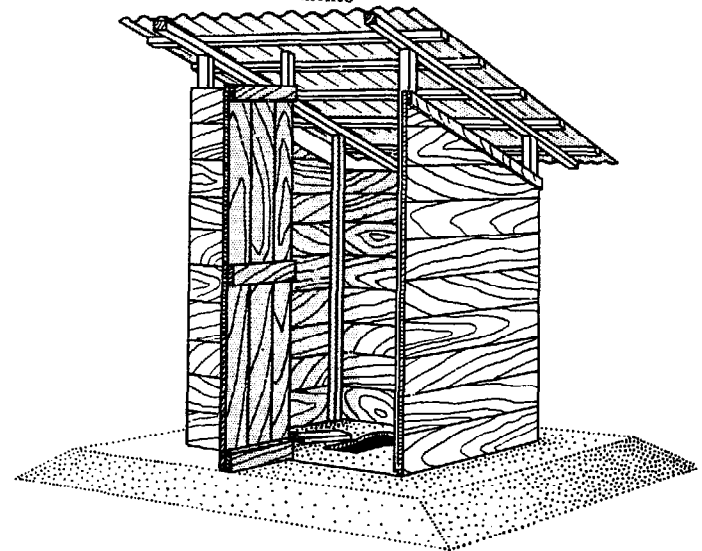

Large volume pit
Hueco con volumen grande

Electrical Systems

Sistemas Eléctricos

A three wire system is used in homes to provide both 120 and 240 volts. 120 volts is used for lights and small appliances. 240 is used for large appliances such as electric stoves, water heaters, etc.

Un sistema a tres alambres se emplea en casas para 120 and 240 voltios. Se emplean 120 voltios para las luces y recipientes. 240 voltios se emplean para estufas eléctricas, etc.

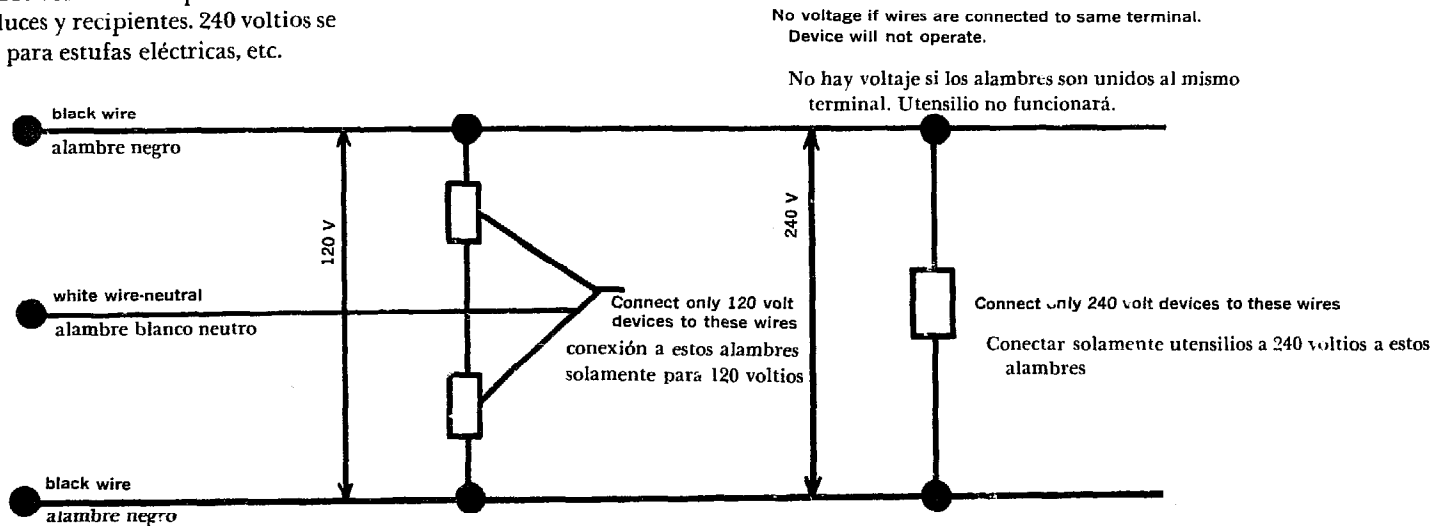

Switch Box
Toma de Corriente

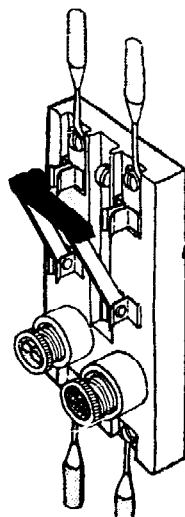

fuse
tapón fusible

two-fuse circuitbreaker
interruptor de navajas con fusibles, dos polos

for inside installation
a la instalación interior

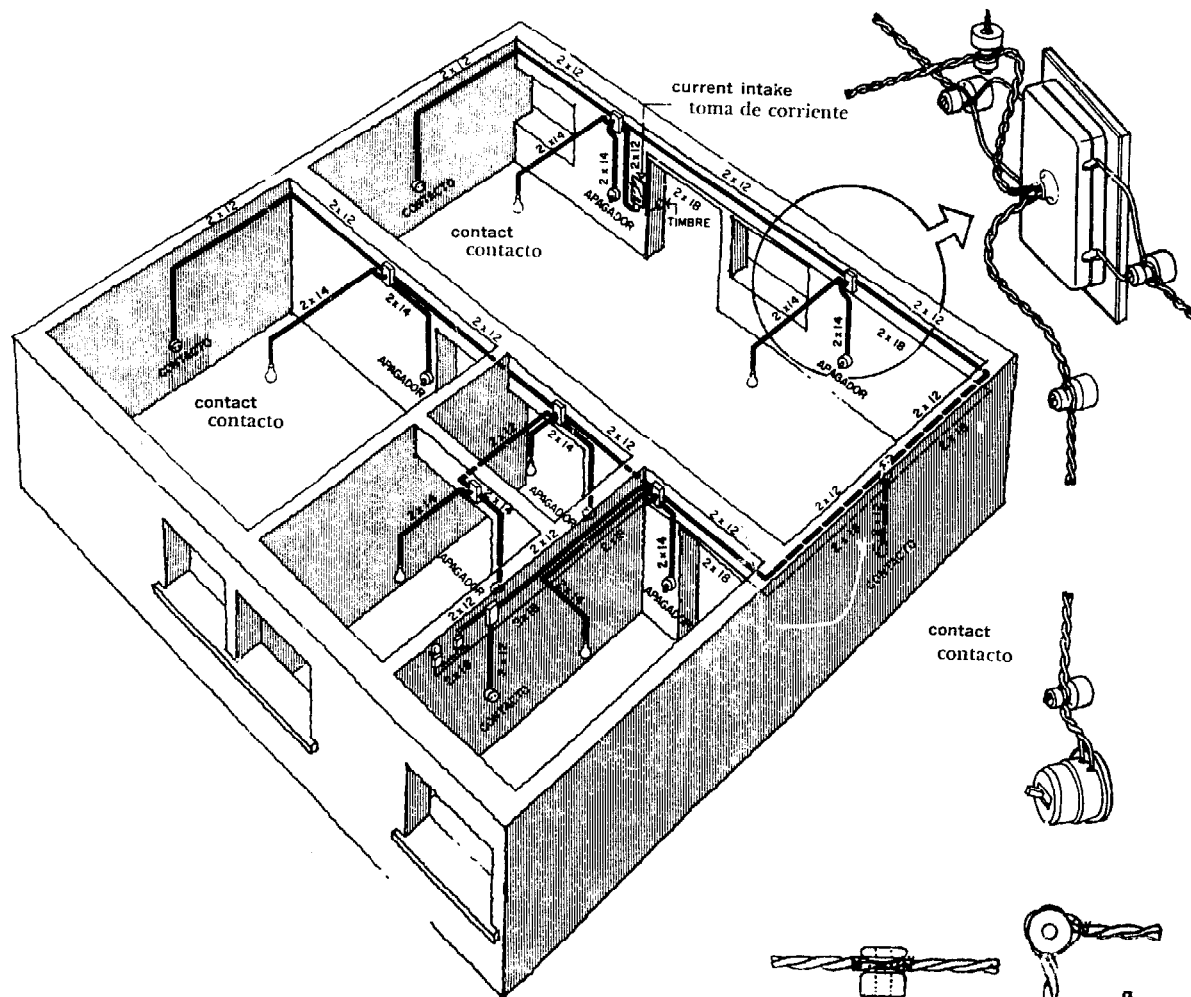

contacto
contacto

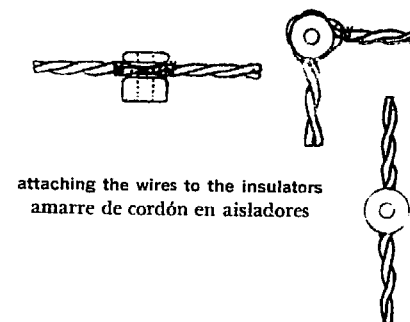

attaching the wires to the insulators
amarre de cordón en aisladores



OCULTA

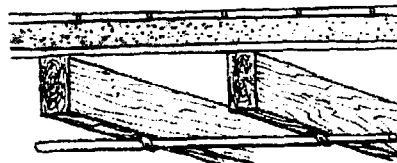

VISIBLE

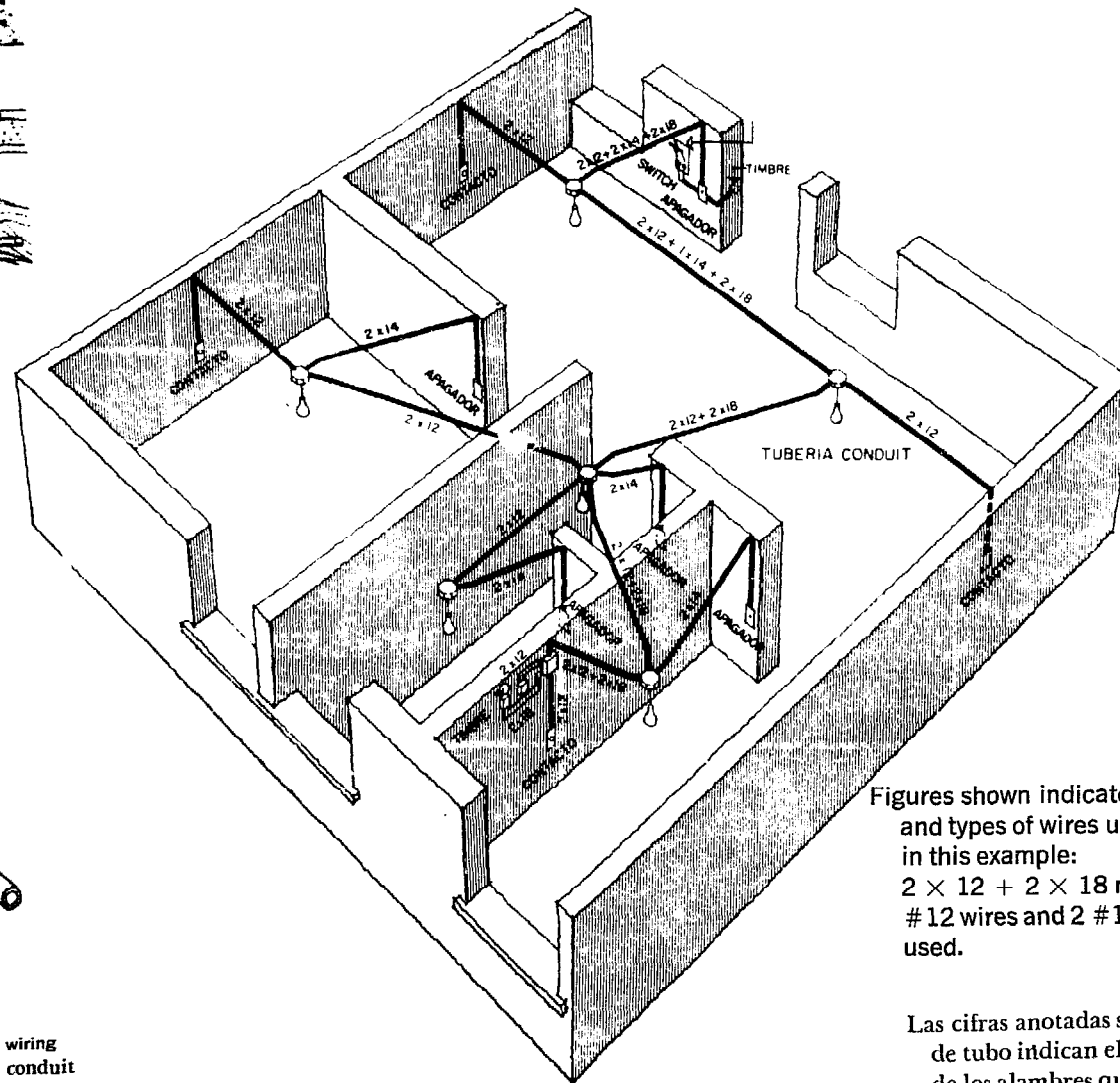

Figures shown indicate the number and types of wires used in this example:

$2 \times 12 + 2 \times 18$ means that two #12 wires and 2 #18 wires were used.

Las cifras anotadas sobre tramo de tubo indican el número y calibre de los alambres que van en ese tramo (ejemplo: $2 \times 12 + 2 \times 18$ significa que se pondrán 2 alambres del 12 y 2 alambres del 18.)

seal
timbre

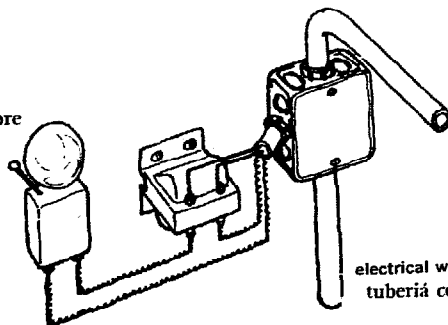

electrical wiring
tubería conduit

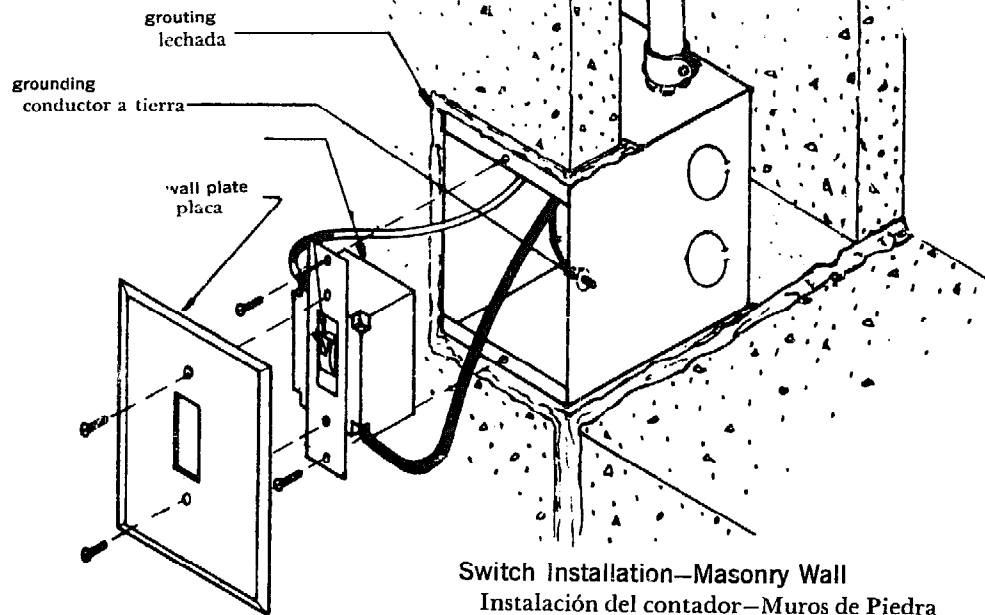

Switch Installation—Masonry Wall
 Instalación del contador—Muros de Piedra

